

ELEVATION VIEW

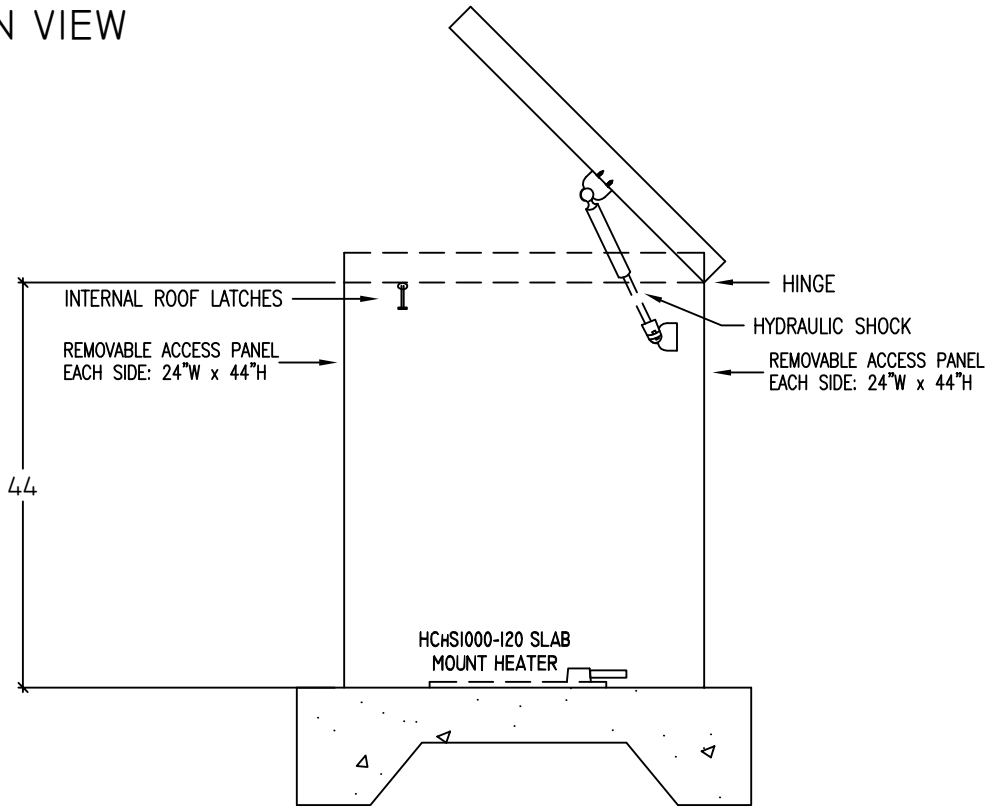

PLAN VIEW

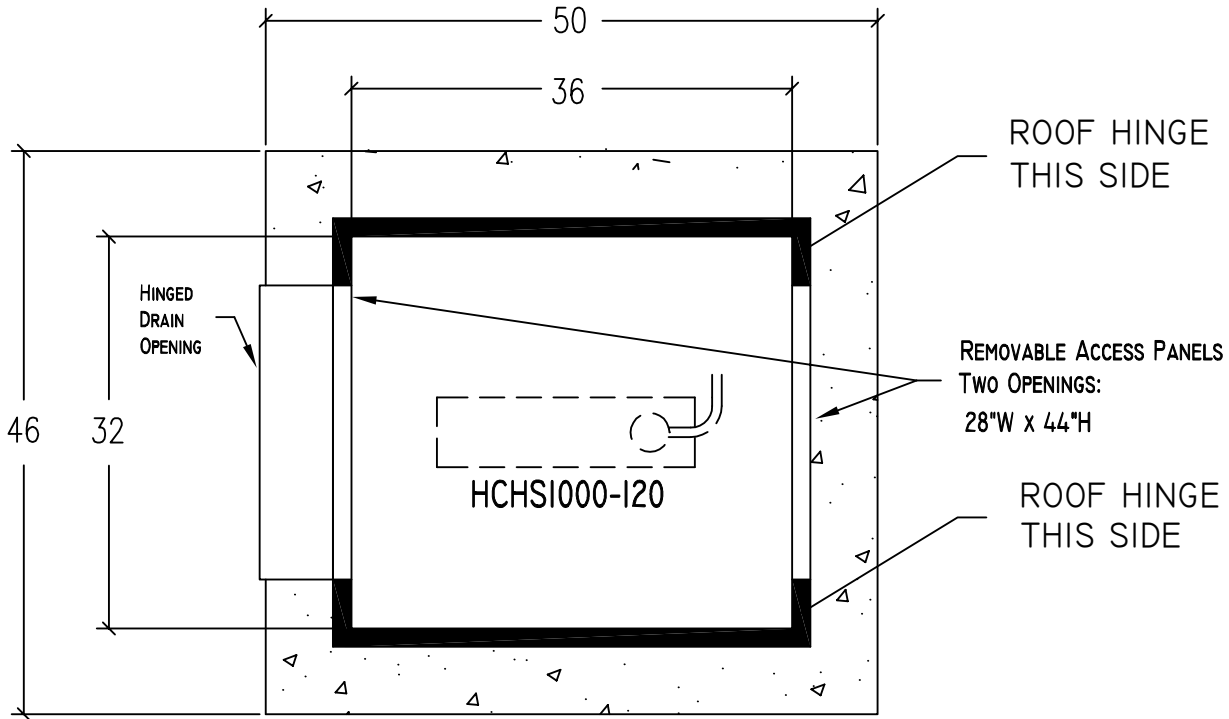

400LU880-AL

SHEET 1 OF 1

5. MODEL 400LU880-AL ENCLOSURE

6. ENCLOSURE INSIDE DIMENSIONS:

32"W X 36"L X 44"H

7. CONCRETE PAD IS 46"W X 50"L X 6"H

1. DRAWING NOT TO SCALE.

2. ALL DIMENSIONS ARE IN INCHES.

3. WALL AND INSULATION THICKNESS IS 1-1/2".

4. ROOF AND INSULATION THICKNESS IS 3".