

For Non-Health Hazard Applications

Job Name _____
 Job Location _____
 Engineer _____
 Approval _____

Contractor _____
 Approval _____
 Contractor's P.O. No. _____
 Representative _____

Series 757DCDA, 757NDCDA

Double Check Detector Assemblies

Sizes: 2½" – 10" (65 – 250mm)

Series 757DCDA, 757NDCDA Double Check Detector Assemblies are used to prevent backflow of non-health hazard pollutants that are objectionable but not toxic, from entering the potable water supply system. The 757DCDA, 757NDCDA may be installed under continuous pressure service and may be subjected to backpressure and backsiphonage. Series 757DCDA, 757NDCDA is used primarily on fire line sprinkler systems when it is necessary to monitor unauthorized use of water.

Features

- Extremely compact design
- 70% Lighter than traditional designs
- 304 (Schedule 40) stainless steel housing & sleeve
- Groove fittings allow integral pipeline adjustment
- Patented tri-link spring check provides lowest pressure loss
- Unmatched ease of serviceability
- Available with grooved butterfly valve shutoffs
- May be used for horizontal, vertical or N pattern installations
- Replaceable check disc rubber

Specifications

The Double Check Detector Assembly shall consist of two independent tri-link check modules within a single housing, sleeve access port, four test cocks and two drip tight shutoff valves. Tri-link checks shall be removable and serviceable, without the use of special tools. The housing shall be constructed of 304 Schedule 40 stainless steel pipe with groove end connections. Tri-link checks shall have reversible elastomer discs and in operation shall produce drip tight closure against reverse flow caused by backpressure or backsiphonage. The bypass assembly shall consist of a meter, which registers in either gallon or cubic measurement, a double check backflow assembly and required test cocks. Assembly shall be a Watts Series 757DCDA, 757NDCDA.



757DCDAOSY



757DCDABFG



757NDCDAOSY

NOTICE

The information contained herein is not intended to replace the full product installation and safety information available or the experience of a trained product installer. You are required to thoroughly read all installation instructions and product safety information before beginning the installation of this product.

Available Models

Suffix:

- OSY – UL/FM outside stem and yoke resilient seated gate valves
- BFG – UL/FM grooved gear operated butterfly valves with tamper switch
- *OSY FxG – Flanged inlet gate connection and grooved outlet gate connection
- *OSY GxF – Grooved inlet gate connection and flanged outlet gate connection
- *OSY GxG – Grooved inlet gate connection and grooved outlet gate connection

Available with grooved NRS gate valves - consult factory*

Post indicator plate and operating nut available - consult factory*

*Consult factory for dimensions

Materials

Housing & Sleeve: 304 (Schedule 40) Stainless Steel

Elastomers: EPDM, Silicone and Buna-N

Tri-link Checks: Noryl®, Stainless Steel

Check Discs: Reversible Silicone or EPDM

Test Cocks: Bronze Body Nickel Plated

Pins & Fasteners: 300 Series Stainless Steel

Springs: Stainless Steel

Pressure – Temperature

Temperature Range: 33°F – 140°F (0.5°C – 60°C)

Maximum Working Pressure: 175psi (12.1 bar)

Approvals

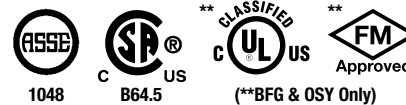

Dimensions – Weight

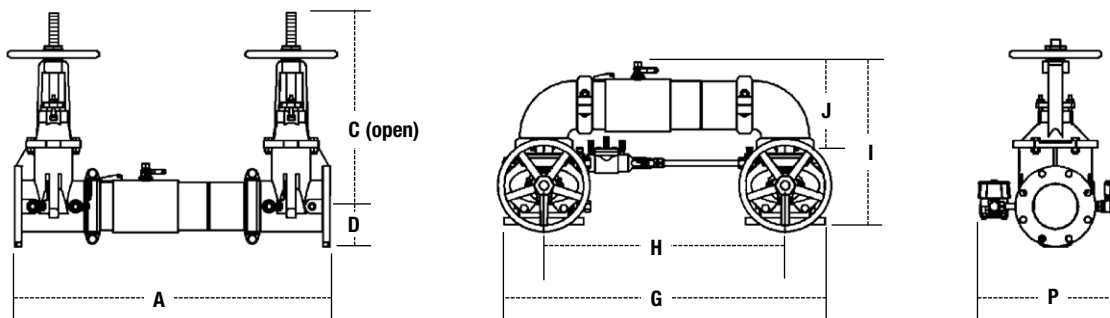

757DCDA , 757NDCDA

SIZE (DN)		DIMENSIONS				WEIGHT						757DCDA		757NDCDA							
in.	mm	A		C (OSY)		D		G		H		I		J		P		lbs.	kgs.	lbs.	kgs.
2½	65	30¾	781	16⅞	416	3½	89	29⅞	738	21½	546	15½	393	8⅜	223	13⅞	335	139	63	147	67
3	80	31¾	806	18⅞	479	3⅞	94	30¼	768	22¼	565	17⅞	435	9⅞	233	14½	368	159	72	172	78
4	100	33¾	857	22¾	578	4	102	33	838	23½	597	18½	470	9⅞	252	15⅞	386	175	79	198	90
6	150	43½	1105	30⅞	765	5½	140	44¾	1137	33¾	845	23⅞	589	13⅞	332	19	483	309	140	350	159
8	200	49¾	1264	37¾	959	6⅞	170	54⅞	1375	40⅞	1019	27⅞	697	15⅞	399	21⅞	538	494	224	569	258
10	250	57¾	1467	45¾	1162	8⅞	208	66	1676	49⅞	1257	32½	826	17⅞	440	24	610	795	361	965	438

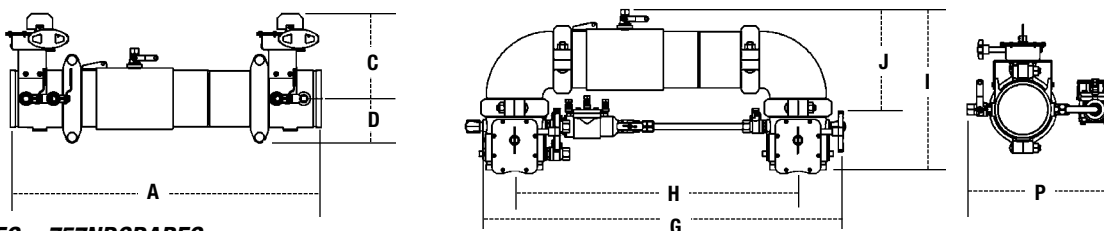

757DCDABFG , 757NDCDABFG

SIZE (DN)		DIMENSIONS				WEIGHT						757DCDABFG		757NDCDABFG							
in.	mm	A		C		D		G		H		I		J		P		lbs.	kgs.	lbs.	kgs.
2½	65	27¾	705	8	203	3½	89	29⅞	759	21½	546	14⅞	379	8⅜	223	13	330	70	32	78	35
3	80	28¾	718	8⅞	211	3⅞	94	30⅞	779	22¼	565	15⅞	392	9⅞	233	13½	343	68	31	81	37
4	100	29	737	8⅞	227	3⅞	94	31⅞	811	23½	597	16¼	412	9⅞	252	14	356	75	34	98	44
6	150	36½	927	10	254	5	127	43⅞	1097	33¾	845	19⅞	500	13⅞	332	14½	368	131	59	171	78
8	200	42¾	1086	12¼	311	6½	165	51⅞	1297	40⅞	1019	23⅞	592	15⅞	399	18⅞	462	275	125	351	159

Noryl® is a registered trademark of General Electric Company.

Capacity

Series 757DCDA, 757NDCDA flow curves as tested by Underwriters Laboratory.

Flow characteristics collected using butterfly shutoff valves

_____ Horizontal _____ Vertical - - - - - N - Pattern

Flow capacity chart identifies valve performance based upon rated water velocity up to 25fps

- Service Flow is typically determined by a rated velocity of 7.5fps based upon schedule 40 pipe.
- Rated Flow identifies maximum continuous duty performance determined by AWWA.
- UL Flow Rate is 150% of Rated Flow and is not recommended for continuous duty.
- AWWA Manual M22 [Appendix C] recommends that the maximum water velocity in services be not more than 10fps.

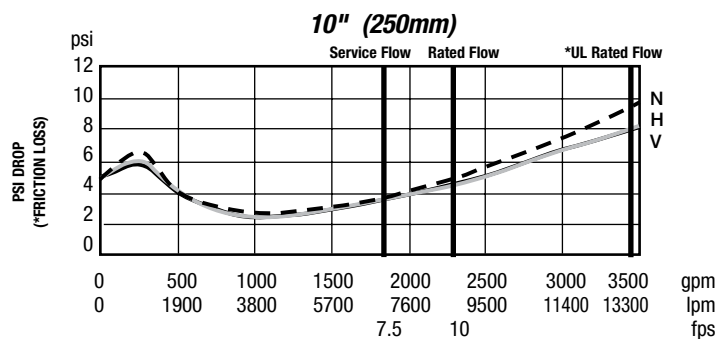
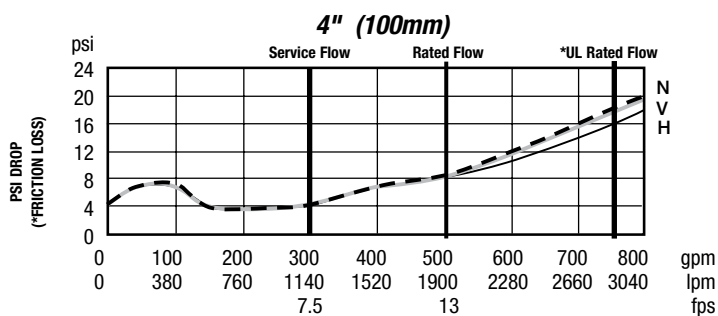
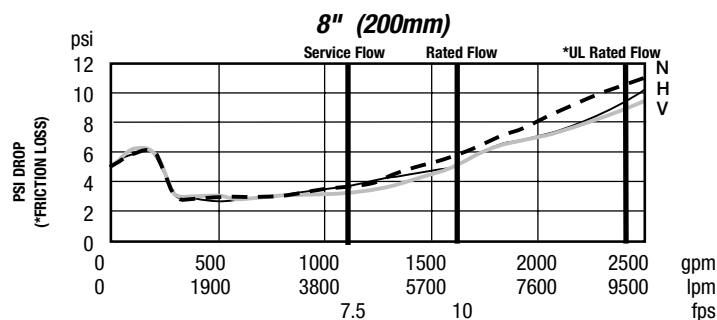
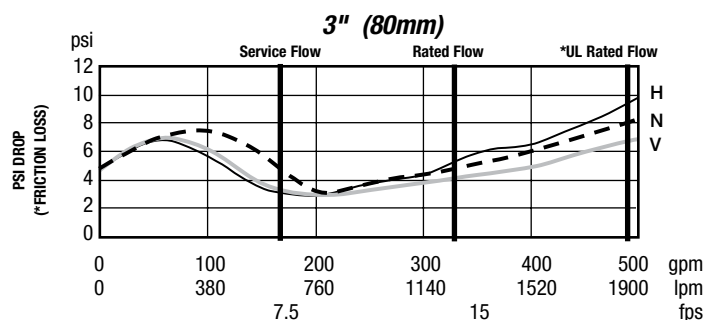
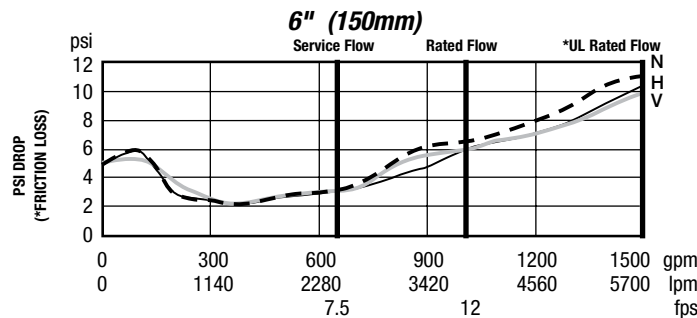
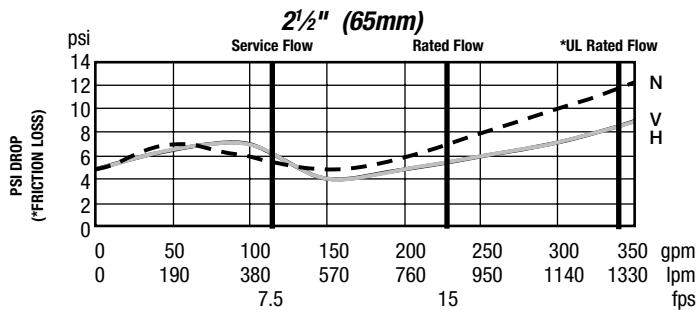

NOTICE

Inquire with governing authorities for local installation requirements

WARNING

It is illegal to use this product in any plumbing system providing water for human consumption, such as drinking or dishwashing, in the United States. Before installing standard material product, consult your local water authority, building and plumbing codes.



A Watts Water Technologies Company