

For Non-Health Hazard Applications

Job Name _____

Contractor _____

Job Location _____

Approval _____

Engineer _____

Contractor's P.O. No. _____

Approval _____

Representative _____

Series 774DCDA

Double Check Detector Assemblies

Sizes 2½" – 12" (65 – 300mm)

Series 774DCDA Double Check Detector Assemblies are designed for use in accordance with water utility non-health hazard containment requirements. It is mandatory to prevent the reverse flow of fire protection system substances, i.e., glycerin wetting agents, stagnant water and water of non-potable quality from being pumped or siphoned into the potable water supply.

Features

- Torsion spring check valve provides low head loss
- Short lay length is ideally suited for retrofit installations
- Stainless steel body is half the weight of competitive designs reducing installation and shipping cost
- Stainless steel construction provides long term corrosion protection and maximum strength
- Single top access cover with two-bolt grooved style coupling for ease of maintenance
- Thermoplastic and stainless steel check valves for trouble-free operation
- No special tools required for servicing
- Compact construction allows for smaller vaults and enclosures
- Furnished with ⅝" x ¾" (16x19mm) bronze meter (gpm or cfm)
- Detects underground leaks and unauthorized water use
- May be installed horizontal or vertical "flow up" position

Specifications

A Double Check Detector Assembly shall be installed on fire protection systems when connected to a potable water supply. Degree of hazard present is determined by the local authority having jurisdiction. The assembly shall consist of two positive seating check valves located between two resilient seated shutoffs with a hydraulically balanced bypass line and four test cocks. The main valve body shall be manufactured from 300 Series stainless steel to provide corrosion resistance. The check valves shall be of thermoplastic construction with stainless steel hinge pins, cam arm and cam bearing. The check valves shall utilize a single torsion spring design to minimize pressure drop through the assembly. The check valves shall be modular and shall seal to the main valve body by the use of an O-ring. There shall be no brass or bronze parts used within the check valve assembly. The check valve seats shall be of molded thermoplastic construction. The use of seat screws as a retention method is prohibited. All internal parts shall be accessible through a single cover on the valve assembly. The valve cover shall be held in place through the use of a single grooved style two-bolt coupling. The bypass line shall be hydraulically sized to accurately measure low flow. The bypass line shall consist of a meter, a small diameter double check assembly with test cocks and isolation valves. The bypass line double check valve shall have two independently operating modular poppet check valves, and top mounted test cocks. The assembly shall be a Watts Series 774DCDA.

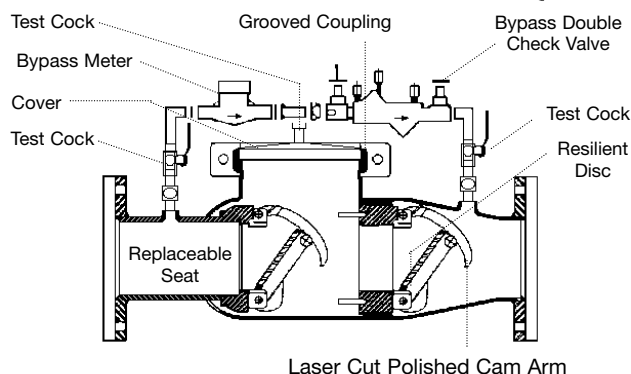
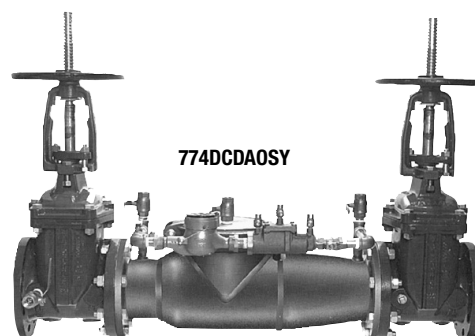

Available Models

Suffix:

LF – without shutoff valves

OSY – UL/FM outside stem and yoke resilient seated gate valves

*OSY FxF – flanged inlet gate connection and grooved outlet gate connection

*OSY GxF – grooved inlet gate connection and flanged outlet gate connection

*OSY GxG – grooved inlet gate connection and grooved outlet gate connection

CFM – cubic feet per minute meter

GPM – gallons per minute meter

Available with grooved NRS gate valves - consult factory*

Post indicator plate and operating nut available - consult factory*

*Consult factory for dimensions

Now Available

WattsBox Insulated Enclosures.

For more information, send for literature ES-WB.

**IMPORTANT: INQUIRE WITH GOVERNING AUTHORITIES
FOR LOCAL INSTALLATION REQUIREMENTS**

Materials

All internal metal parts: 300 Series stainless steel, Main valve body: 300 Series stainless steel, Check assembly: Noryl® Flange dimensions in accordance with AWWA Class D.

Pressure - Temperature

Temperature Range: 33°F – 110°F (0.5°C – 43°C) continuous
Pressure Range: 175psi (12.1 bar)

Capacity

Flow curves as tested by Underwriters Laboratory per UL 1469, 1996 * Rated flow **UL Tested

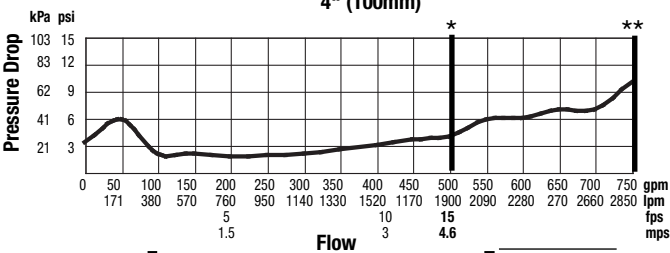
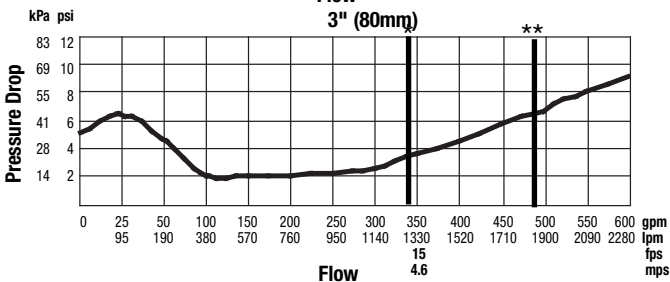
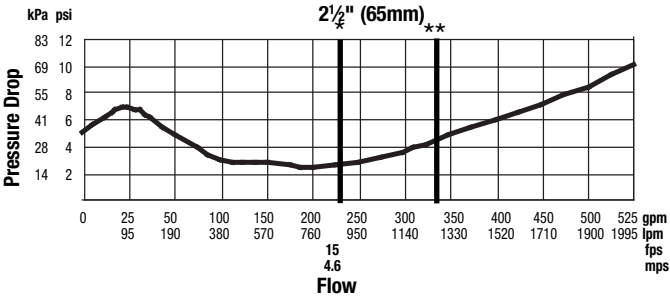

Standards

AWWA C510, CSA B64.5

Approvals

(2½" - 10" only)
(65 - 250mm)



(OSY only)

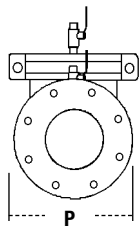
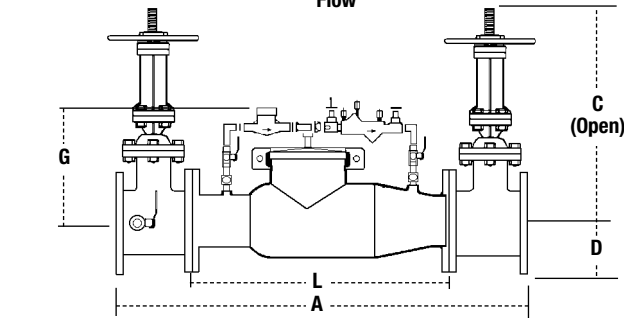
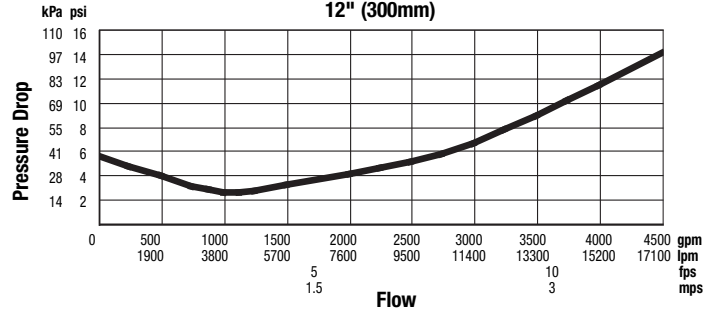
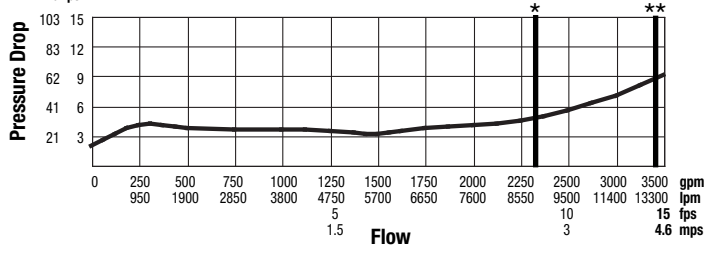
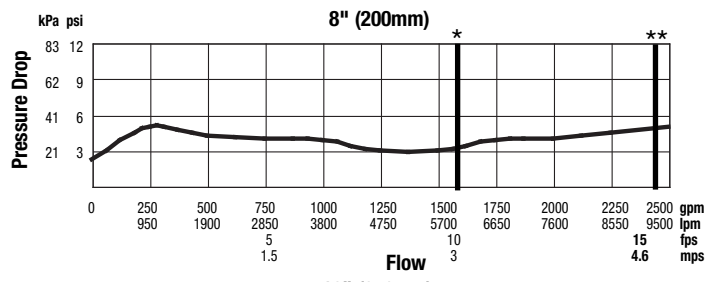
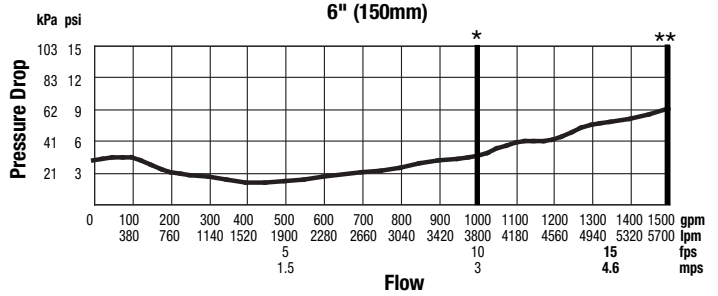

Noryl® is a registered trademark of SABIC Innovative Plastics™.

SIZE (DN)	DIMENSIONS								WEIGHT										
	in.	mm	A		C (OSY)		D		G		L		P		w/Gates		w/o Gates		
		in.	mm	in.	mm	in.	mm	in.	mm	in.	mm	in.	mm	in.	mm	lbs.	kgs.	lbs.	kgs.
2½	65	38	965	16¾	416	3½	89	10	250	22	559	12½	318	155	70	68	31		
3	80	38	965	18¾	479	3¾	95	10	250	22	559	13	330	230	104	70	32		
4	100	40	1016	22¾	578	4½	114	10	250	22	559	14½	368	240	109	73	33		
6	150	48½	1232	30¾	765	5½	140	15	381	27½	699	15½	394	390	177	120	54		
8	200	52½	1334	37¾	959	6¾	171	15	381	29½	749	18¾	464	572	259	180	82		
10	250	55½	1410	45¾	1162	8	200	15	381	29½	749	19½	495	774	351	190	86		
12	300	57½	1461	53¾	1349	9½	241	15	381	29½	749	21	533	1044	474	220	100		



A Watts Water Technologies Company



USA: No. Andover, MA • Tel: (978) 688-1811 • Fax: (978) 794-1848 • www.watts.com
Canada: Burlington, ON • Tel: (905) 332-4090 • Fax: (905) 332-7068 • www.wattscanada.ca