

Series 825Y

Reduced Pressure Zone Assemblies

Size: ¾" - 2" (20mm - 50mm)

The FEBCO Series 825Y Reduced Pressure Zone Assemblies are used to protect against high hazard (toxic) fluids in water services to industrial plants, hospitals, morgues, mortuaries, and chemical plants. They are also used in irrigation systems, boiler feed, water lines and other installations requiring maximum protection.

Features

- Ultimate mechanical protection of potable water, against hazards of cross-connection contamination.
- Meets all specifications of AWWA, ASSE, and CSA.
- Approved by the Foundation of Cross-Connection Control and Hydraulic Research at the University of Southern California.
- Modular relief valve for ease of maintenance.
- Simple Service procedures. All internal parts serviceable in line.
- Low head loss.
- Spring loaded "Y" type check valves.
- Internal relief valve pressure sensing passages.
- Replaceable seat rings on all sizes.
- End connection – NPT ANSI / ASME B1.20.1

Specifications

The reduced pressure zone assembly shall consist of two independently operating, spring loaded, "Y" pattern check valves and one hydraulically dependent differential relief valve. The assembly shall automatically reduce the pressure in the "zone" between the check valves to at least 5psi lower than inlet pressure. Should the differential between the upstream and the zone of the unit drop to 2psi, the differential relief valve shall open and maintain the proper differential.

Mainline valve body and caps including relief valve body and cover shall be bronze. Check valve moving member shall be center stem guided. All hydraulic sensing passages shall be internally located within the mainline and relief valve bodies and relief valve cover. Diaphragm to seat area ratio shall be 10:1 minimum. Relief valve shall have a removable seat ring. Check valve and relief valve components shall be constructed so they may be serviced without removing the valve body from the line. All seat discs shall be reversible. Shutoff valves and test cocks shall be full ported ball valves.

The assembly shall be rated to 175psi (12.1 bar) working pressure and water temperature range from 32°F to 140°F (0°C - 60°C).

The assembly shall meet the requirements of ASSE Standard 1013; AWWA Standard Code C511; CSA Standard B64.4; and approved by the Foundation for Cross-Connection Control and Hydraulic Research at the University of Southern California.

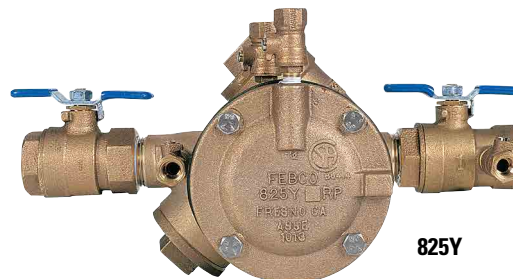

Operation

In a flow condition the check valves are open with the pressure between the checks, called the zone, being maintained at least 5.0psi lower than the inlet pressure and the relief valve is maintained closed.

Should abnormal conditions arise under no flow or reversal of flow, the differential relief valve will open and discharge to maintain the zone at least 2psi lower than the supply.

When normal flow resumes, the zone's differential pressure will resume and the relief valve will close.

Typical Installation

Reduced pressure zone assemblies should be installed with minimum clearance of 12" (300mm) between relief valve discharge port and floor or grade. They must be installed where discharge will not be objectionable and can be positively drained away. They should be installed where easily accessible for testing and maintenance and must be protected from freezing. Thermal water expansion and/or water hammer downstream of the backflow preventer can cause excessive pressure. Excessive pressure situations should be eliminated to avoid possible damage to the system and assembly.

Refer to local codes for specific installation requirements. Some codes may prohibit vertical installation.

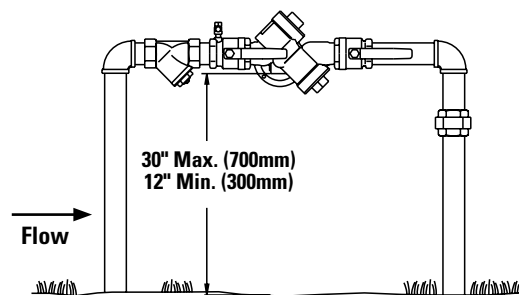

⚠ WARNING

It is illegal to use this product in any plumbing system providing water for human consumption, such as drinking or dishwashing, in the United States. Before installing standard material product, consult your local water authority, building and plumbing codes.

Job Name _____

Job Location _____

Engineer _____

Approval _____

Contractor _____

Approval _____

Contractor's P.O. No. _____

Representative _____

Capacity

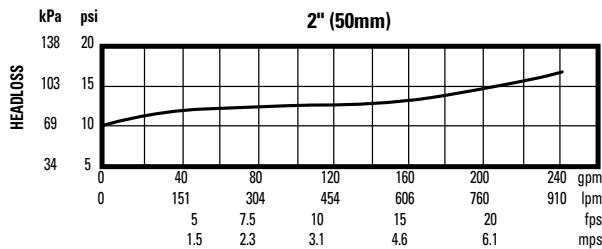
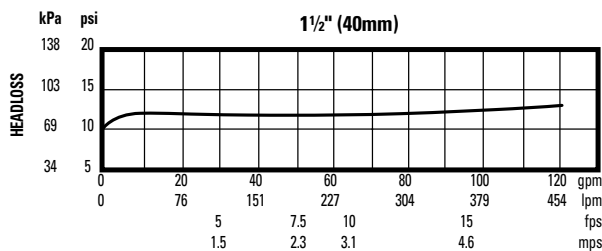
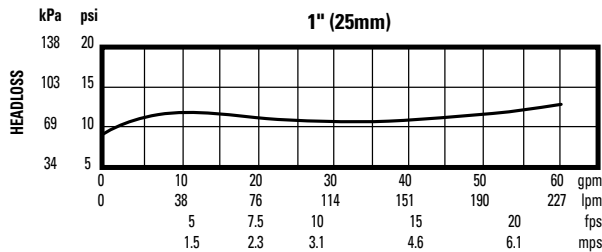
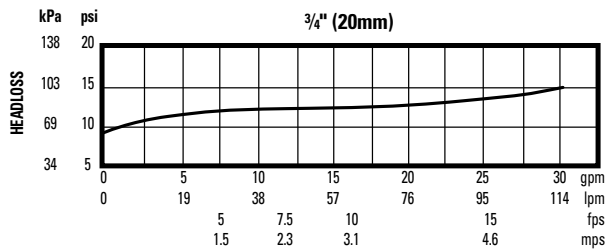

Dimensions – Weights

Size: 3/4" - 2" (20 - 50mm)

| SIZE (DN) | | DIMENSIONS | | | | | | | | | | WEIGHT | |
|-----------|----|------------|-----|--------|-----|-------|-----|-------|-----|-------|-----|--------|------|
| | | A | | B* | | C | | D | | E | | lbs. | kgs. |
| in. | mm | in. | mm | in. | mm | in. | mm | in. | mm | in. | mm | | |
| 3/4 | 20 | 12 | 305 | 7 3/4 | 197 | 3 1/4 | 83 | 3 1/4 | 83 | 4 1/8 | 105 | 11.5 | 5.2 |
| 1 | 25 | 12 3/4 | 324 | 7 3/4 | 197 | 3 1/4 | 83 | 3 1/4 | 83 | 4 1/8 | 105 | 12.5 | 5.7 |
| 1 1/2 | 40 | 17 | 432 | 10 1/2 | 267 | 4 1/2 | 114 | 4 1/2 | 114 | 5 | 127 | 26.5 | 12.0 |
| 2 | 50 | 17 3/4 | 451 | 10 1/2 | 267 | 4 1/2 | 114 | 4 1/2 | 114 | 5 | 127 | 29.0 | 13.0 |

* B Dimension is less shutoffs

NOTICE

Weights shown are approximate. Dimensions shown are nominal, allowance must be made for normal manufacturing tolerances.



A Watts Water Technologies Company

Temperature – Pressure

Maximum working pressure: 175psi (12.1 bar)

Hydrostatic test pressure: 350psi (24.1 bar)

Temperature range: 32°F to 140°F (0°C to 60°C)

Materials

Main valve body: Bronze

Relief valve body: Bronze

Elastomers: Nitrile Seat Discs

Diaphragms: Nitrile, fabric reinforced

Springs: Stainless Steel

Approvals – Standards

- Approved by the Foundation for Cross-Connection Control and Hydraulic Research at the University of Southern California.

- AWWA C511 Conformance

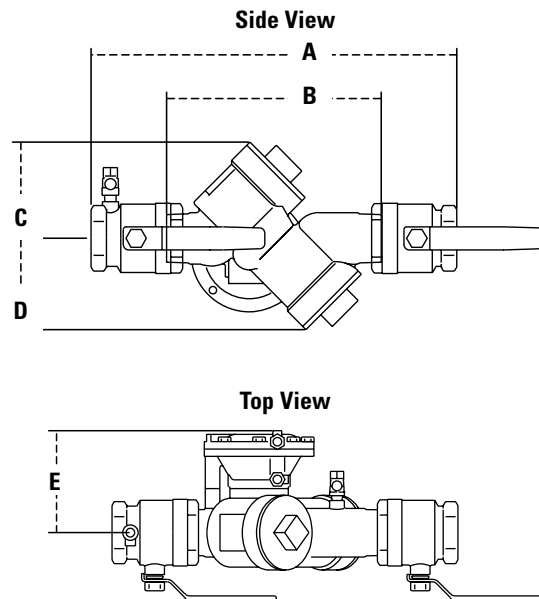

USA: Tel: (800) 767-1234 • Fax: (800) 788-4491 • FEBCOonline.com
 Canada: Tel: (905) 332-4090 • Fax: (905) 332-7068 • FEBCOonline.ca
 Latin America: Tel: (52) 81-1001-8600 • FEBCOonline.com