



Colt™ Series C400, C400N, C400Z

Reduced Pressure Zone Assemblies

Sizes: 2½" – 10" (65 – 250mm)

LEAD FREE*



C400N BFG

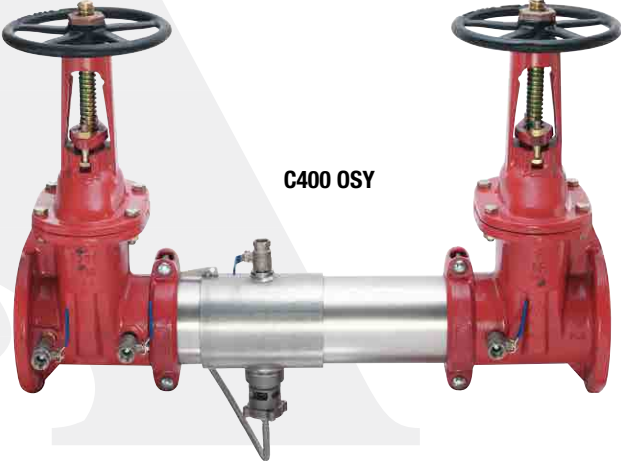

C400 OSY

Features

- Extremely Compact Design
- 70% Lighter than Traditional Designs
- 304 (Schedule 40) Stainless Steel Housing & Sleeve
- Groove Fittings Allow Integral Pipeline Adjustment
- Patented Link Check Provides Lowest Pressure Loss
- Unmatched Ease of Serviceability
- Available with Grooved Butterfly Valve Shutoffs
- May be Used for Horizontal or N Pattern Installations
- Replaceable Check Disc Rubber

The Colt C400, C400N, C400Z Reduced Pressure Zone Assemblies provide protection to the potable water system from contamination in accordance with national plumbing codes. The Colt C400, C400N, C400Z are normally used in health hazard applications for protection against backsiphonage, backpressure and the fouling of either check valve. The Colt C400, C400N, C400Z features Lead Free* construction to comply with Lead Free* installation requirements.

Specifications

The Colt C400, C400N, C400Z Reduced Pressure Zone Assemblies shall consist of two independent Link Check modules, a differential pressure relief valve located between and below the two modules, two drip tight shutoff valves, and required test cocks. Link Check modules and relief valve shall be contained within a sleeve accessible single housing constructed from 304 (Schedule 40) stainless steel pipe with groove end connections. Link Checks shall have reversible elastomer discs and in operation produce drip tight closure against the reverse flow of liquid caused by backpressure or backsiphonage. Lead Free* Reduced Pressure Zone Assemblies shall be constructed using Lead Free* materials. It shall comply with state codes and standards, where applicable, requiring reduced lead content. Assembly shall be Colt C400, C400N, C400Z as manufactured by the Ames Company.

NOTICE

The information contained herein is not intended to replace the full product installation and safety information available or the experience of a trained product installer. You are required to thoroughly read all installation instructions and product safety information before beginning the installation of this product.

NOTICE

Inquire with governing authorities for local installation requirements

*The wetted surface of this product contacted by consumable water contains less than 0.25% of lead by weight.

Job Name _____ Contractor _____

Job Location _____ Approval _____

Engineer _____ Contractor's P.O. No. _____

Approval _____ Representative _____

Ames Fire & Waterworks product specifications in U.S. customary units and metric are approximate and are provided for reference only. For precise measurements, please contact Ames Fire & Waterworks Technical Service. Ames Fire & Waterworks reserves the right to change or modify product design, construction, specifications, or materials without prior notice and without incurring any obligation to make such changes and modifications on Ames Fire & Waterworks products previously or subsequently sold.

Configurations

- Horizontal
- “Z” pattern horizontal
- “N” pattern horizontal

Materials

- Housing & Sleeve: 304 (Schedule 40) Stainless Steel
- Elastomers: EPDM, Silicone and Buna ‘N’
- Link Checks: Noryl®, Stainless Steel
- Check Discs: Reversible Silicone or EPDM
- Test Cocks: Bronze Body Nickel Plated
- Pins & Fasteners: 300 Series Stainless Steel
- Springs: Stainless Steel

Noryl® is a registered trademark of SABIC Innovative Plastics™.

Approvals



For additional approval information please contact the factory or visit our website at www.amesfirewater.com

Pressure — Temperature

Temperature Range: 33°F – 140°F (0.5°C – 60°C)

Maximum Working Pressure: 175psi (12.1 bar)

Note: When installing a drain line on Series C400 backflow preventer use 400/500 air gap. See ES-A-AG/EL/TC for additional information.

Available Models

Suffix:

NRS - non-rising stem resilient seated gate valves

OSY - UL/FM outside stem and yoke resilient seated gate valves

BFG - UL/FM grooved gear operated butterfly valves with tamper switch

*OSY FxG - Flanged inlet gate connection and grooved outlet gate connection

*OSY GxF - Grooved inlet gate connection and flanged outlet gate connection

*OSY GxG - Grooved inlet gate connection and grooved outlet gate connection

Available with grooved NRS gate valves - consult factory*

Post indicator plate and operating nut available - consult factory*

*Consult factory for dimensions

Dimensions — Weights

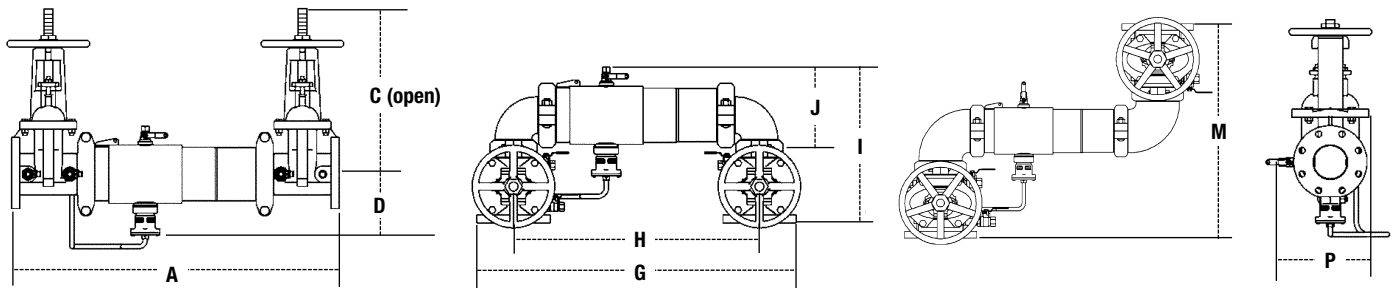

C400, C400N, C400Z

SIZE (DN)		DIMENSIONS										WEIGHT																	
		A		C (OSY)		C (NRS)		D		G		H		I		J		M		P		C400		C400N					
in.	mm	in.	mm	in.	mm	in.	mm	in.	mm	in.	mm	in.	mm	in.	mm	in.	mm	in.	mm	in.	mm	lbs.	kgs.	lbs.	kgs.	lbs.	kgs.	lbs.	kgs.
2½	65	30¾	781	16¾	416	9¾	238	6½	165	29⅞	738	21½	546	15½	393	8⅜	223	21¼	540	9⅞	234	118	54	128	58	126	57	136	62
3	80	31¾	806	18¾	479	10¼	260	6⅞	170	30¼	768	22¼	565	17⅞	435	9⅞	233	23	584	10½	267	134	61	148	67	147	67	161	73
4	100	33¾	857	22¾	578	12⅞	310	7	178	33	838	23½	597	18½	470	9⅞	252	26¼	667	11⅞	284	164	74	164	74	187	85	187	85
6	150	43½	1105	30¾	765	16	406	8½	216	44¼	1137	35¼	895	23⅞	589	13⅞	332	34¼	870	15	381	276	125	298	135	317	144	339	154
8	200	49¾	1264	37¾	959	19⅞	506	9⅞	246	54⅞	1375	40⅞	1019	27⅞	697	15⅞	399	36⅞	937	17⅞	437	441	200	483	219	516	234	558	253
10	250	57¾	1467	45¾	1162	23⅞	605	11¾	285	66	1676	49½	1257	32½	826	17⅞	440	44½	1124	20	508	723	328	783	355	893	405	950	431

Dimensions — Weights

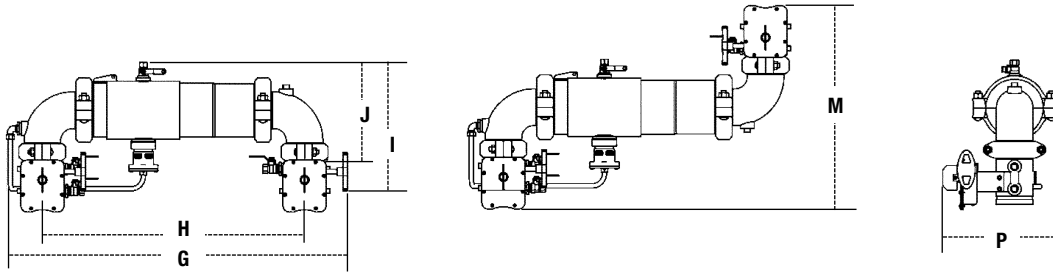

C400NBF/C400ZBFG

SIZE (DN)		DIMENSIONS										WEIGHT			
in.	mm	G		H		I		J		M		P		C400N, C400Z	
		in.	mm	in.	mm	in.	mm	in.	mm	in.	mm	in.	mm	lbs.	kgs.
2½	65	23	584	23	584	15½	394	9½	241	19¾	502	11 ¹³ / ₁₆	300	67	30
3	80	24	610	24	610	16 ⁵ / ₁₆	414	10 ¹ / ₁₆	256	21¼	540	12 ¹ / ₈	308	70	32
4	100	25½	648	25½	648	17 ³ / ₁₆	437	10 ¹⁵ / ₁₆	279	23½	597	12 ⁵ / ₈	321	87	39
6	150	35¼	895	35¼	895	20½	521	13½	343	27¼	692	15	382	160	73

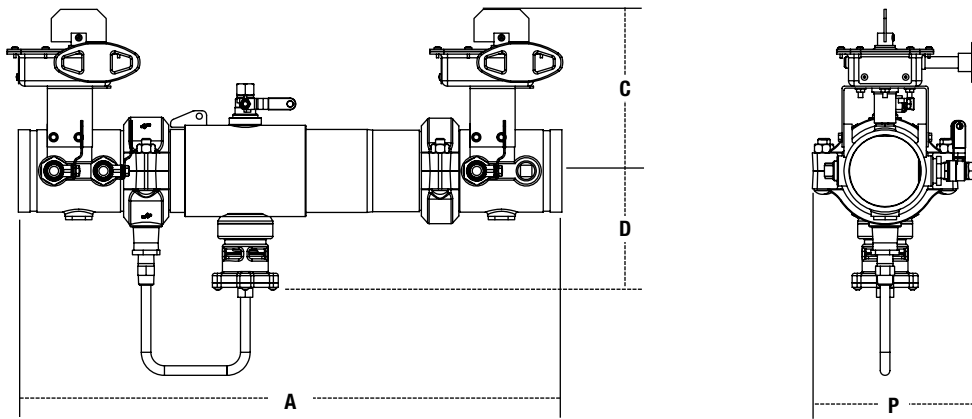

C400 BFG

SIZE (DN)		DIMENSIONS						WEIGHT			
in.	mm	A		C		D		P			
		in.	mm	in.	mm	in.	mm	in.	mm	lbs.	kgs.
4	100	29	737	7¾	197	6 ³ / ₈	162	9½	241	66	30
6	150	36½	927	9 ¹ / ₁₆	246	7 ¹ / ₁₆	189	14¼	362	122	55

Capacity - C400 BFG

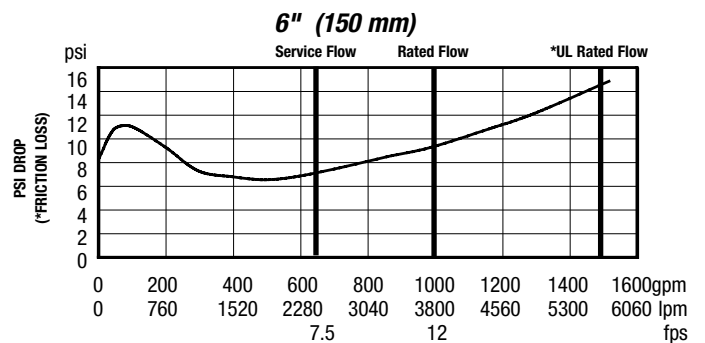
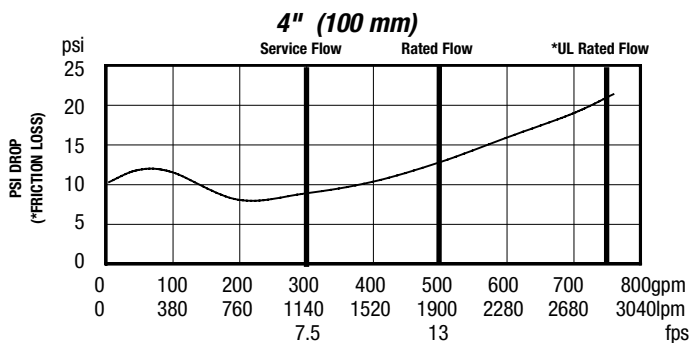

Capacity

UL/FM Certified Flow Characteristics
 N&Z Flow characteristics collected using butterfly shutoff valves.

— Horizontal — N - Pattern - - - - Z - Pattern

Flow capacity chart identifies valve performance based upon rated water velocity up to 25fps

- Service Flow is typically determined by a rated velocity of 7.5fps based upon schedule 40 pipe.
- Rated Flow identifies maximum continuous duty performance determined by AWWA.
- UL Flow Rate is 150% of Rated Flow and is not recommended for continuous duty.
- AWWA Manual M22 [Appendix C] recommends that the maximum water velocity in services be not more than 10fps.

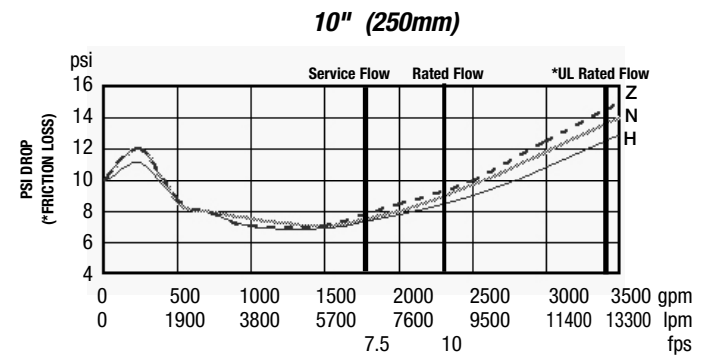
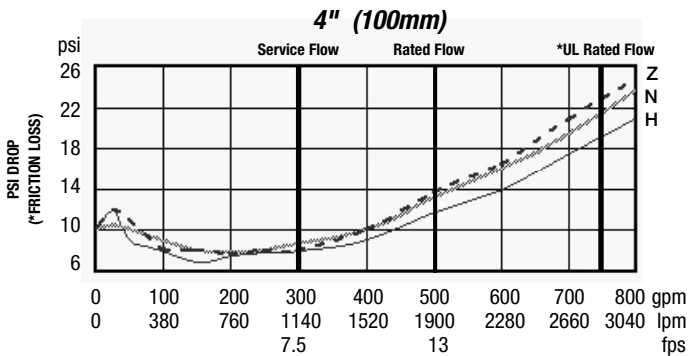
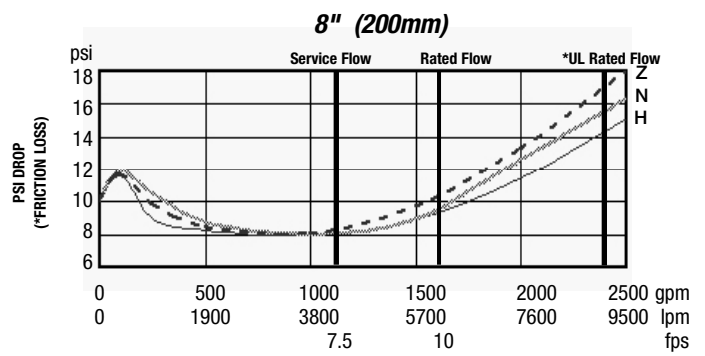
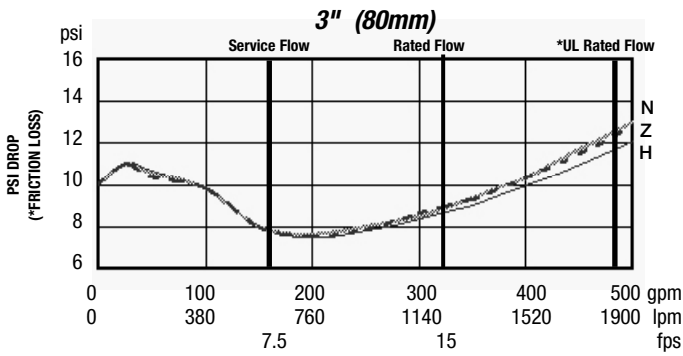
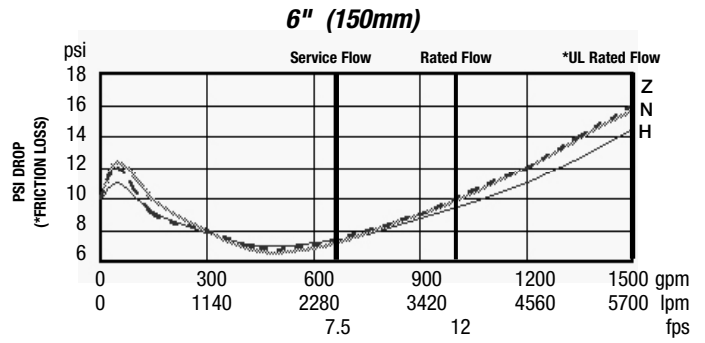
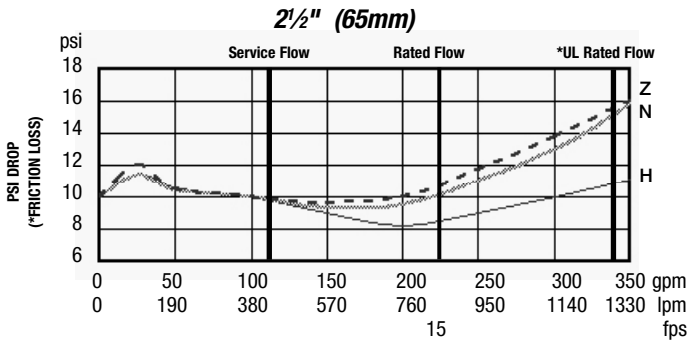

NOTICE

Inquire with governing authorities for local installation requirements



A Watts Water Technologies Company

USA: Backflow Tel: (978) 689-6066 • Fax: (978) 975-8350 • AmesFireWater.com
 USA: Control Valves Tel: (713) 943-0688 • Fax: (713) 944-9445 • AmesFireWater.com
 Canada: Tel: (905) 332-4090 • Fax: (905) 332-7068 • AmesFireWater.ca
 Latin America: Tel: (52) 81-1001-8600 • Fax: (52) 81-8000-7091 • AmesFireWater.com