



Colt™ Series C500, C500N, C500Z

Reduced Pressure Detector Assemblies

Sizes: 2½" – 10" (65 – 250mm)



C500N OSY

Features

- Extremely Compact Design
- 70% Lighter than Traditional Designs
- 304 (Schedule 40) Stainless Steel Housing & Sleeve
- Groove Fittings Allow Integral Pipeline Adjustment
- Patented Link Check Provides Lowest Pressure Loss
- Unmatched Ease of Serviceability
- Replaceable Check Disc Rubber
- Available with Grooved Butterfly Valve Shutoffs
- Bottom Mounted Cast Stainless Steel Relief Valve
- Metered Bypass to Detect Leakage or Theft of Water from the Fire Sprinkler System

The Colt C500, C500N, C500Z Reduced Pressure Detector Assemblies are designed to protect drinking water supplies from dangerous cross-connections in accordance with national plumbing codes and water authority requirements for health-hazard non-potable service applications such as irrigation, fire line, or industrial processing. The Colt C500, C500N, C500Z are used to monitor unauthorized use of water from the fire protection system.

Specifications

The Colt C500, C500N, C500Z Reduced Pressure Detector Assemblies shall consist of two independent Link Check modules, a differential pressure relief valve located between and below the two modules, two drip tight shutoff valves, and required test cocks. Link Check modules and relief valve shall be contained within a sleeve accessible single housing constructed from 304 (Schedule 40) stainless steel pipe with groove end connections. Link Checks shall have reversible elastomer discs and in operation produce drip tight closure against the reverse flow of liquid caused by backpressure or backsiphonage. The bypass assembly consists of a meter registering either gallon or cubic measurements, a reduced pressure zone assembly and required test cocks. Assembly shall be Colt C500, C500N, C500Z as manufactured by the Ames Company.

⚠ WARNING

It is illegal to use this product in any plumbing system providing water for human consumption, such as drinking or dishwashing, in the United States. Before installing standard material product, consult your local water authority, building and plumbing codes.

NOTICE

The information contained herein is not intended to replace the full product installation and safety information available or the experience of a trained product installer. You are required to thoroughly read all installation instructions and product safety information before beginning the installation of this product.

Job Name _____ Contractor _____

Job Location _____ Approval _____

Engineer _____ Contractor's P.O. No. _____

Approval _____ Representative _____

Configurations

- Horizontal
- “Z” pattern horizontal
- “N” pattern horizontal

Materials

- Housing & Sleeve: 304 (Schedule 40) Stainless Steel
- Elastomers: EPDM, Silicone and Buna ‘N’
- Link Checks: Noryl®, Stainless Steel
- Check Discs: Reversible Silicone or EPDM
- Test Cocks: Bronze Body Nickel Plated
- Pins & Fasteners: 300 Series Stainless Steel
- Springs: Stainless Steel

Available Models

Suffix:

OSY - UL/FM outside stem and yoke resilient seated gate valves

BFG - UL/FM grooved gear operated butterfly valves w/tamper switch

*OSY FxG - Flanged inlet gate connection and grooved outlet gate connection

*OSY GxG - Grooved inlet gate connection and flanged outlet gate connection

*OSY GxG - Grooved inlet gate connection and grooved outlet gate connection

Available with grooved NRS gate valves - consult factory*

Post indicator plate and operating nut available - consult factory*

*Consult factory for dimensions

Pressure — Temperature

Temperature Range: 33°F – 140°F (0.5°C – 60°C)

Maximum Working Pressure: 175psi (12.1 bar)

Dimensions — Weights

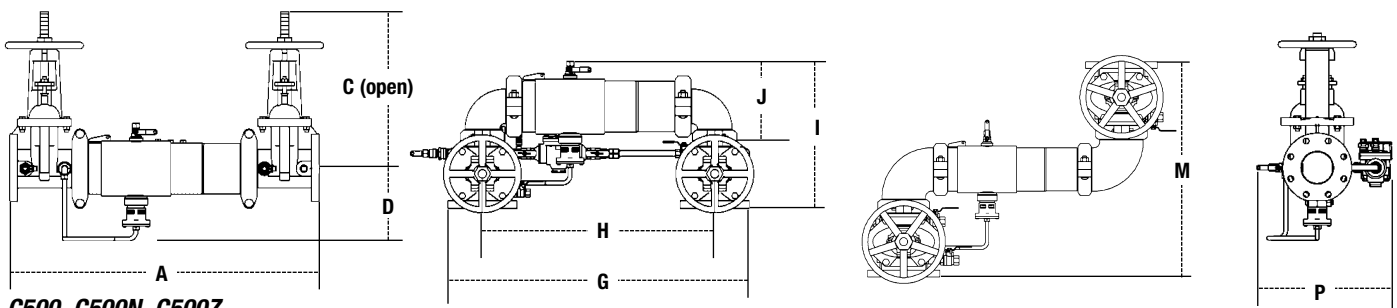

C500, C500N, C500Z

SIZE (DN)		DIMENSIONS										WEIGHT											
in.	mm	A		C (OSY)		D		G		H		I		J		M		P		C500		C500N	
		in.	mm	in.	mm	in.	mm	in.	mm	in.	mm	in.	mm	in.	mm	in.	mm	in.	mm	lbs.	kgs.	lbs.	kgs.
2½	65	30¾	781	16¾	416	6½	165	29½	738	21½	546	15½	393	8½	223	21¼	540	13¾	335	142	64	150	68
3	80	31¾	806	18¾	479	6½	170	30¼	768	22¼	565	17½	435	9¼	233	23	584	14½	368	162	73	175	79
4	100	33¾	857	22¾	578	7	178	33	838	23½	597	18½	470	9½	252	26¼	667	15½	386	178	81	201	91
6	150	43½	1105	30¾	765	8½	216	44¾	1137	33¼	845	23¾	589	13½	332	32¼	819	19	483	312	142	353	160
8	200	49¾	1264	37¾	959	9½	246	54¾	1375	40½	1019	27¾	697	15½	399	36¾	937	21¾	538	497	225	572	259
10	250	57¾	1467	45¾	1162	11¾	285	66	1676	49½	1257	32½	826	17¾	440	44½	1124	24	610	797	362	964	437

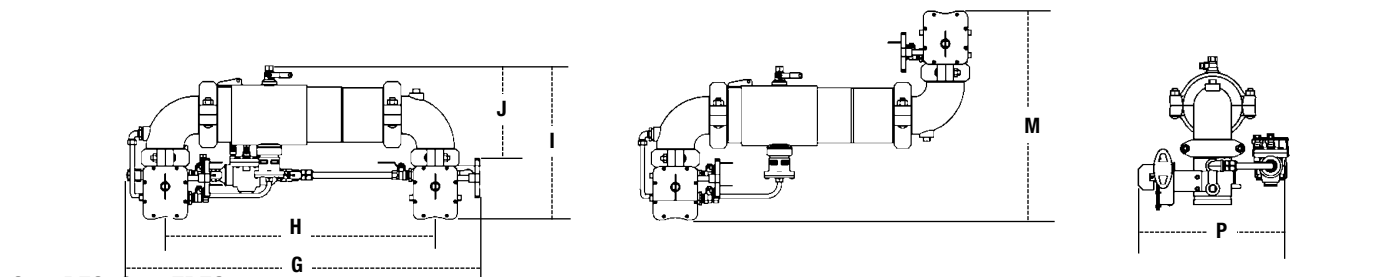

C500BFG, C500ZBFG

SIZE (DN)		DIMENSIONS								WEIGHT					
in.	mm	G		H		I		J		M		P		C500BFG	
		in.	mm	in.	mm	in.	mm	in.	mm	in.	mm	in.	mm	lbs.	kgs.
2½	65	32½	826	23	584	15½	394	9½	241	19¾	502	15½	402	81	37
3	80	34	864	24	610	16½	414	10½	256	21¼	540	16½	410	84	38
4	100	35¾	905	25½	648	17¾	437	10¾	279	23½	597	16¾	422	101	46
6	150	46½	1181	35¼	895	20½	521	13½	343	27¼	692	19	483	174	79

Noryl® is a registered trademark of SABIC Innovative Plastics™.

Approvals

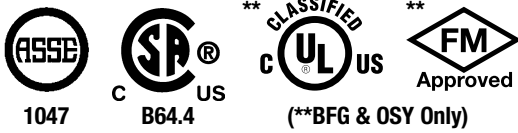

For additional approval information please contact the factory or visit our website at www.amesfirewater.com

Capacity

UL/FM Certified Flow Characteristics
 N&Z Flow characteristics collected using butterfly shutoff valves.

—— Horizontal ——— N - Pattern - - - - Z - Pattern

Flow capacity chart identifies valve performance based upon rated water velocity up to 25fps

- Service Flow is typically determined by a rated velocity of 7.5fps based upon schedule 40 pipe.
- Rated Flow identifies maximum continuous duty performance determined by AWWA.
- UL Flow Rate is 150% of Rated Flow and is not recommended for continuous duty.
- AWWA Manual M22 [Appendix C] recommends that the maximum water velocity in services be not more than 10fps.

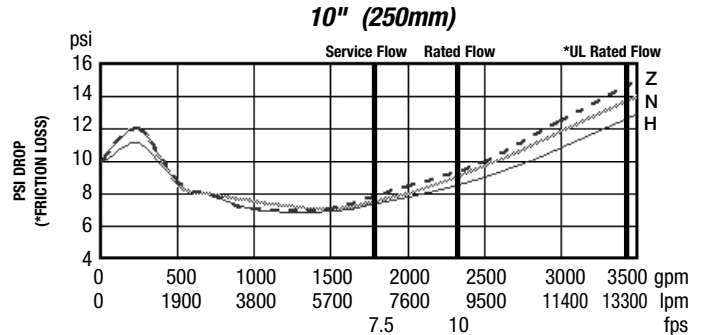
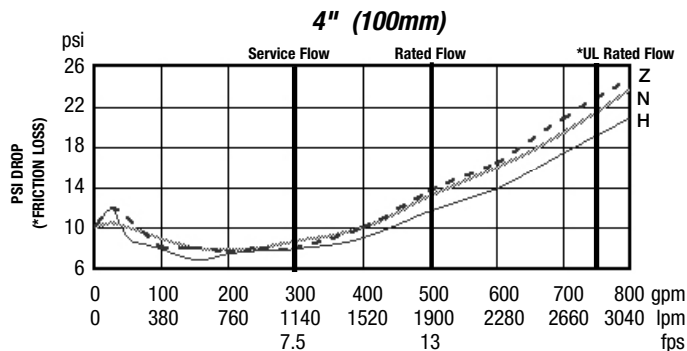
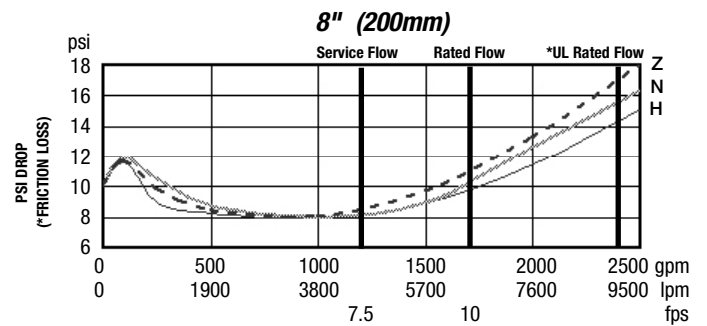
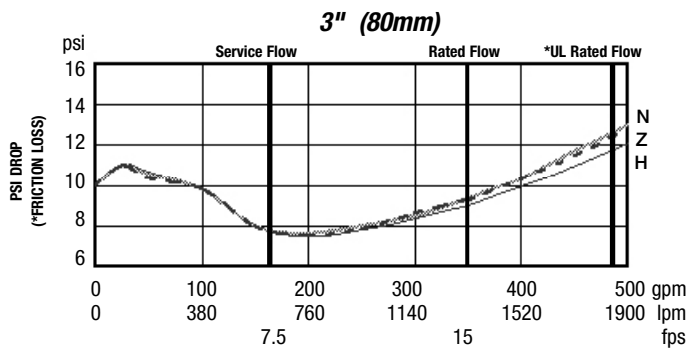
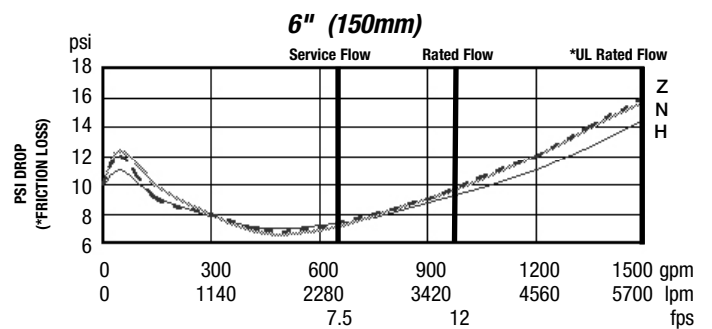
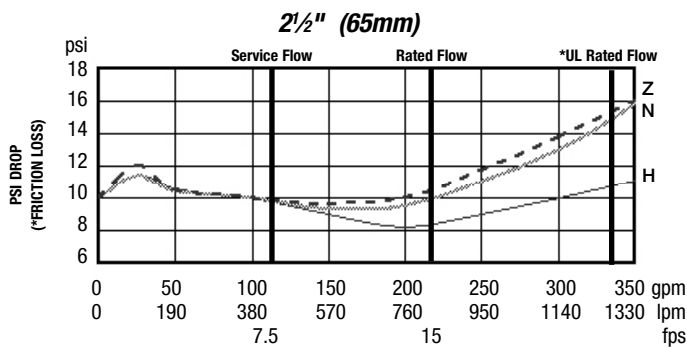

NOTICE

Inquire with governing authorities for local installation requirements



A Watts Water Technologies Company

USA: Backflow Tel: (978) 689-6066 • Fax: (978) 975-8350 • AmesFireWater.com
USA: Control Valves Tel: (713) 943-0688 • Fax: (713) 944-9445 • AmesFireWater.com
Canada: Tel: (905) 332-4090 • Fax: (905) 332-7068 • AmesFireWater.ca
Latin America: Tel: (52) 81-1001-8600 • Fax: (52) 81-8000-7091 • AmesFireWater.com