



Maxim™ Series M200, M200N

Double Check Valve Assemblies

Sizes: 2 1/2" – 10" (65 – 250mm)

LEAD FREE*

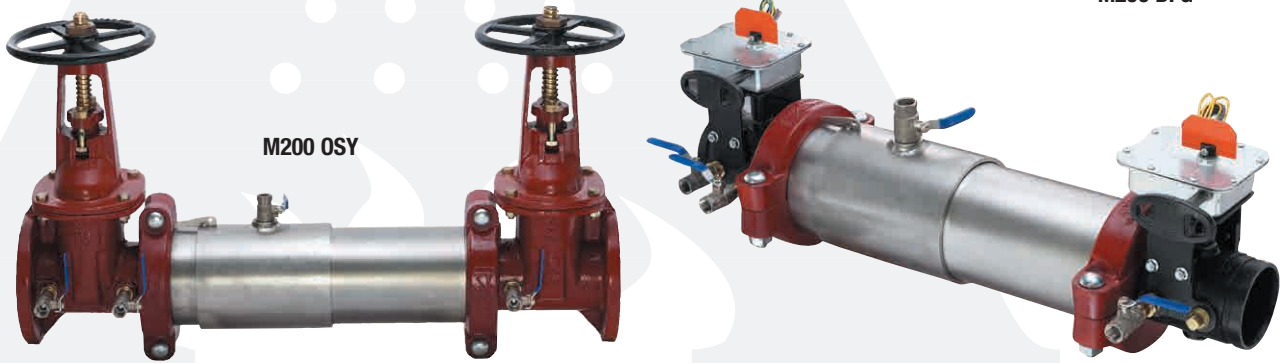

Features

- Extremely Compact Design
- 70% Lighter than Traditional Designs
- 304 (Schedule 40) Stainless Steel Housing & Sleeve
- Groove Fittings Allow Integral Pipeline Adjustment
- Patented Tri-Link Checks Provides Lowest Pressure Loss
- Unmatched Ease of Serviceability
- Available with Grooved Butterfly Valve Shutoffs
- Available for Horizontal, Vertical or N Pattern Installations
- Replaceable Check Disc Rubber

The Maxim M200, M200N Double Check Valve Assemblies are used to prevent backflow of pollutants, that are objectionable but not toxic, from entering the potable water supply system. The Maxim M200, M200N may be installed under continuous pressure service and may be subjected to backpressure. The Maxim M200, M200N consists of two independently operating check valves, two shutoff valves, and four test cocks. For use in non-health hazard applications.

Specifications

The Double Check Valve Assemblies shall consist of two independent Tri-Link Check modules within a single housing, sleeve access port, four test cocks and two drip tight shutoff valves. Tri-Link Checks shall be removable and serviceable, without the use of special tools. The housing shall be constructed of 304 (Schedule 40) stainless steel pipe with groove end connections. Tri-Link Checks shall have reversible elastomer discs and in operation shall produce drip tight closure against the reverse flow of liquid caused by backpressure or backsiphonage. Assembly shall be a Maxim M200, M200N as manufactured by the Ames Company.

NOTICE

The information contained herein is not intended to replace the full product installation and safety information available or the experience of a trained product installer. You are required to thoroughly read all installation instructions and product safety information before beginning the installation of this product.

*The wetted surface of this product contacted by consumable water contains less than 0.25% of lead by weight.

Job Name _____ Contractor _____

Job Location _____ Approval _____

Engineer _____ Contractor's P.O. No. _____

Approval _____ Representative _____

Configurations

- Horizontal
- Vertical up
- “N” pattern horizontal

Materials

- Housing & Sleeve: 304 (Schedule 40) Stainless Steel
- Elastomers: EPDM, Silicone and Buna ‘N’
- Tri-Link Checks: Noryl®, Stainless Steel
- Check Discs: Reversible Silicone or EPDM
- Test Cocks: Bronze Body Nickel Plated
- Pins & Fasteners: 300 Series Stainless Steel
- Springs: Stainless Steel

Available Models

OSY- UL/FM outside stem and yoke resilient seated gate valves

BFG- UL/FM grooved gear operated butterfly valves w/tamper switch

NRS- non-rising stem resilient seated gate valves

*OSY FxG- Flanged inlet gate connection and grooved outlet gate connection

*OSY GxF- Grooved inlet gate connection and flanged outlet gate connection

*OSY GxG- Grooved inlet gate connection and grooved outlet gate connection

Available with grooved NRS gate valves - consult factory*

Post indicator plate and operating nut available - consult factory*

*Consult factory for dimensions

Dimensions — Weights

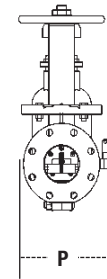
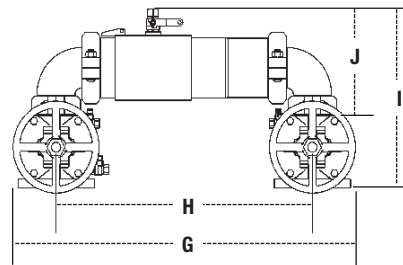
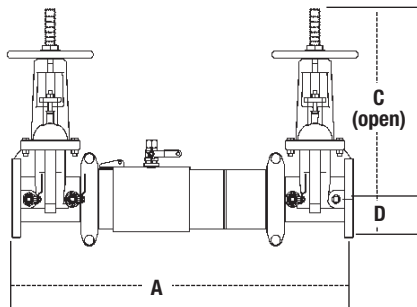

M200, M200N

SIZE (DN)		DIMENSIONS										WEIGHT															
		A	C (OSY)		C (NRS)		D		G		H		I		J		P		M200		M200N						
in	mm	in	mm	in	mm	in	mm	in	mm	in	mm	in	mm	in	mm	in	mm	in	mm	lbs.	kgs.	lbs.	kgs.	lbs.	kgs.	lbs.	kgs.
2½	65	30¾	781	16¾	416	9¾	238	3½	89	29⅞	738	21½	546	15⅓	402	8⅓	223	9⅓	234	125	57	115	52	133	60	122	55
3	80	31¾	806	18⅞	479	10¼	260	3⅞	94	30½	775	22¼	565	17⅞	435	9⅓	233	10½	267	145	66	131	59	158	72	144	65
4	100	40½	1029	22¾	578	12⅓	310	5	127	39¾	1010	30¼	768	20⅞	518	11⅞	297	11⅓	284	225	102	219	99	248	113	242	110
6	150	47¾	1213	30⅞	765	16	406	6½	165	40	1016	37½	953	24¾	629	14⅓	360	15½	394	390	177	368	167	430	195	408	185
8	200	54¾	1391	37¾	959	19⅓	506	7½	191	59⅞	1502	45⅞	1146	28⅞	721	16¾	425	17½	445	564	256	522	237	640	290	598	271
10	250	57¾	1467	45¾	1162	23⅓	605	8⅞	208	66	1676	49½	1257	32½	826	17⅓	440	20	508	781	354	721	327	951	431	890	404

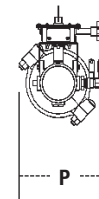
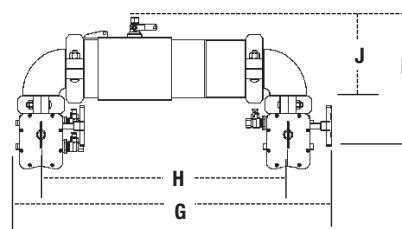
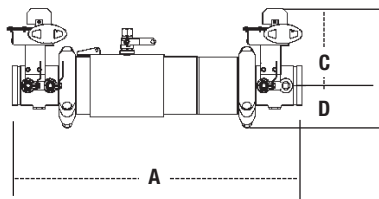

M200BFG, M200NBFG

SIZE (DN)		DIMENSIONS										WEIGHT									
		A	C		D		G		H		I		J		P		M200BFG		M200NBFG		
in.	mm	in.	mm	in.	mm	in.	mm	in.	mm	in.	mm	in.	mm	in.	mm	in.	mm	lbs.	kgs.	lbs.	kgs.
2½	65	27¾	705	8	203	3½	89	29⅞	759	21½	546	14⅓	379	8⅓	223	9	229	56	25	64	29
3	80	28¼	718	8⅓	211	3⅞	94	30¾	781	22¼	565	15⅞	392	9⅓	233	9½	241	54	24	67	30
4	100	35¾	908	8⅞	221	4⅓	122	39	991	30¼	768	18	457	11⅞	297	11	279	119	54	142	64
6	150	40¾	1035	10	254	6	152	47⅞	1205	37½	953	20⅞	525	14⅓	360	15½	394	211	96	251	114
8	200	47¾	1213	12⅓	310	6⅓	173	56	1422	45⅞	1146	24⅞	613	16¾	425	17½	445	345	156	421	191

Noryl® is a registered trademark of SABIC Innovative Plastics™.

Approvals

- Approved by the Foundation for Cross-Connection Control and Hydraulic Research at The University of Southern California (FCCCHR-USC)

For additional approval information please contact the factory or visit our website at www.amesfirewater.com



———— Horizontal ———— Vertical - - - - - N - Pattern

Capacity

UL/FM Certified Flow Characteristics
Flow characteristics collected using butterfly shutoff valves.

Flow capacity chart identifies valve performance based upon rated water velocity up to 25fps

- Service Flow is typically determined by a rated velocity of 7.5fps based upon schedule 40 pipe.
- Rated Flow identifies maximum continuous duty performance determined by AWWA.
- UL Flow Rate is 150% of Rated Flow and is not recommended for continuous duty.
- AWWA Manual M22 [Appendix C] recommends that the maximum water velocity in services be not more than 10fps.

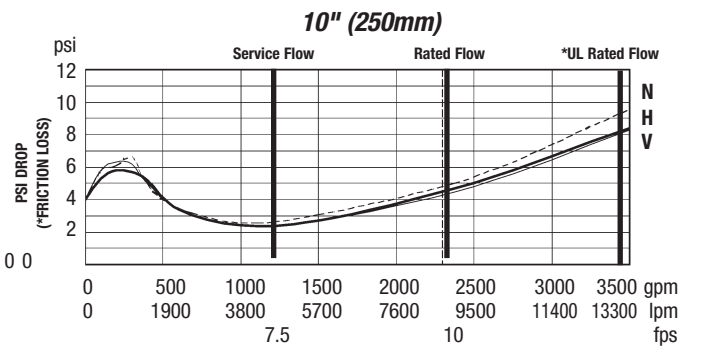
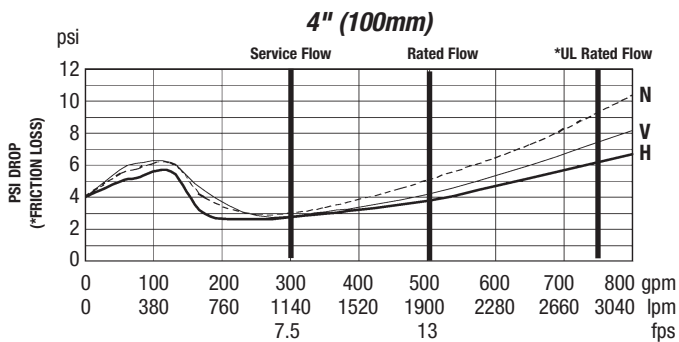
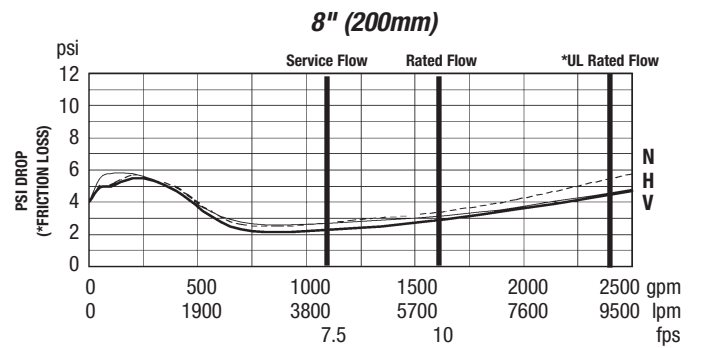
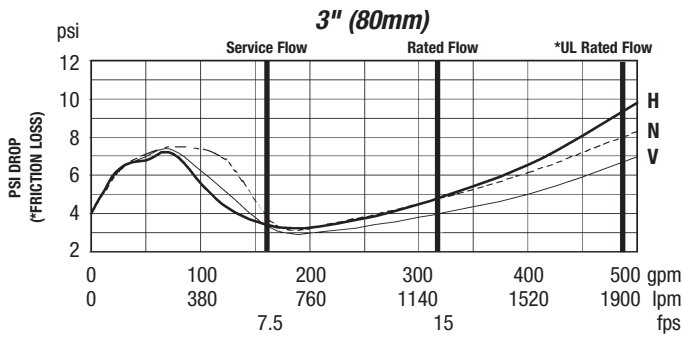
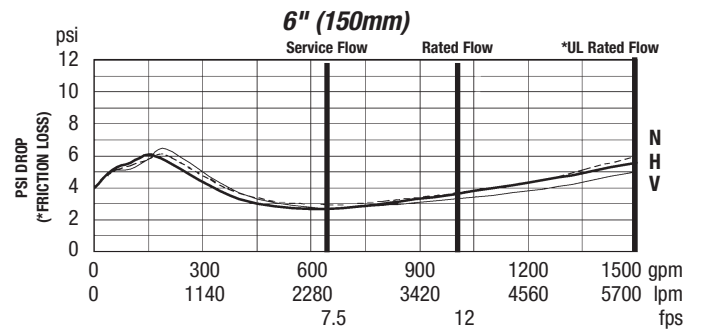
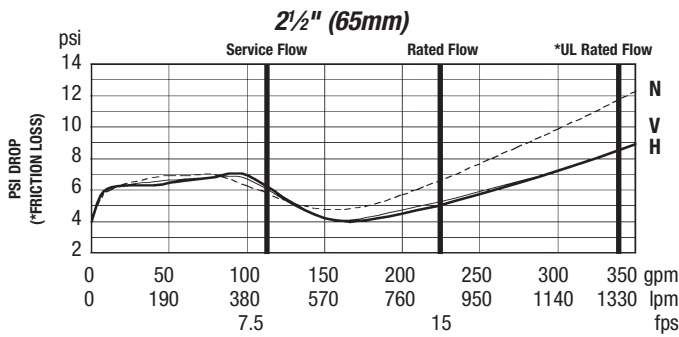

NOTICE

Inquire with governing authorities for local installation requirements



A Watts Water Technologies Company

USA: Backflow Tel: (978) 689-6066 • Fax: (978) 975-8350 • AmesFireWater.com
USA: Control Valves Tel: (713) 943-0688 • Fax: (713) 944-9445 • AmesFireWater.com
Canada: Tel: (905) 332-4090 • Fax: (905) 332-7068 • AmesFireWater.ca
Latin America: Tel: (52) 81-1001-8600 • Fax: (52) 81-8000-7091 • AmesFireWater.com