



# Model FP52

## Elbows



### Application

Zurn elbows maximize configurability of piping with standard radius and short patterned options and a range of bend angles.

- **Grooved End of Run Adapters** provide a grooved end cap with a 90° bend and a threaded outlet; commonly used to attach fire sprinklers to the end of a run of sprinkler piping. Threaded bosses can be used for direct connection of hardware.
- **Drain elbows** are designed with an integral 1" NPT drain to meet requirements of vertical pipe systems.

### Materials

Casting ASTM A536 65-45-12 Ductile Iron

### Standards Compliance

- UL® Listed
- C-UL® Listed
- FM® Approved

### Features

Elbow Sizes: 1 1/4", 1 1/2", 2", 2 1/2", 3", 4", 6", 8", 10"

Elbow Bend Angles: 90°, short radius 90°, 45°, 22.5°, 11.25°

90° Grooved End Adapter Outlets: NPT 1/2", 3/4", 1"

Maximum Pressure:

1 1/4" – 4" Elbows 400 PSI

6"-10" Elbows 300 PSI

Grooved End of Run Adapters 300 PSI

### Options

- S - Short Patterned Radius
- GTF - Grooved End of Run Adapter



4-FP52



4-FP52S

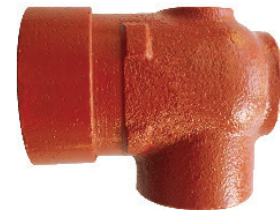

112X12-FP52GTF



4-FP52-45



4-FP52-22



4-FP52-11



# Model FP52(S) | FP52-45

## 90° Standard, Short Run and 45° Elbows



**4-FP52**  
90° Elbow  
Standard Radius



**4-FP52S**  
90° Elbow  
Short Radius



**4-FP52-45**  
45° Elbow

### Dimensions & Weights (do not include pkg.)

SIZE in.	MODEL	Dimensions (approximate)					
		FP52		FP52S		FP52-45	
		C to E in.	Wt. lb.	C to E in.	Wt. lb.	C to E in.	Wt. lb.
1 1/4	114-FP52(S)-XX	2.76	1.2	2.36	1.0	1.73	0.8
1 1/2	112-FP52(S)-XX	2.76	1.2	2.36	1.0	1.73	0.8
2	2-FP52(S)-XX	3.27	1.8	2.76	1.3	2.01	1.2
2 1/2	212-FP52(S)-XX	3.74	2.8	2.99	2.1	2.01	1.7
3	3-FP52(S)-XX	4.25	3.5	3.39	2.6	2.52	4.0
4	4-FP52(S)-XX	5.00	5.8	4.00	3.8	2.99	3.9
6	6-FP52(S)-XX	6.50	14.6	5.51	9.5	3.50	8.3
8	8-FP52(S)-XX	7.76	22.0	6.89	20.9	4.30	14.5
10	10-FP52(S)-XX	9.02	37.7	N/A	N/A	4.76	22.5

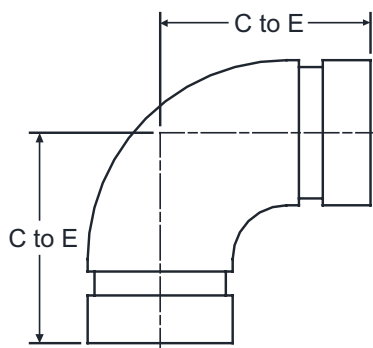

**FP52 | FP52S**

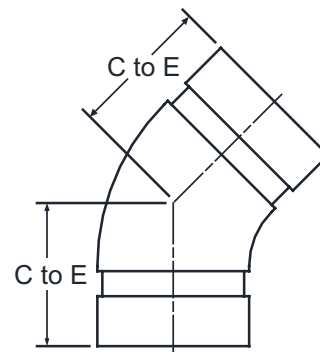

**FP52-45**



# Model FP52-22 | FP52-11

## 22.5°, 11.25° Elbows



**4-FP52-22**  
**22.5° Elbow**



**4-FP52-11**  
**11.25° Elbow**



### Dimensions & Weights (do not include pkg.)

SIZE in.	MODEL	Dimensions (approximate)			
		FP52-22		FP52-11	
		C to E in.	Wt. lb.	C to E in.	Wt. lb.
1 1/2	112-FP52-XX	1.73	0.9	1.38	0.6
2	2-FP52-XX	2.00	1.2	1.38	0.8
2 1/2	212-FP52-XX	2.00	1.5	1.50	1.2
3	3-FP52-XX	2.24	2.6	1.50	1.6
4	4-FP52-XX	2.87	4.0	1.89	2.7
6	6-FP52-XX	3.11	7.3	2.01	4.9
8	8-FP52-XX	3.86	12.1	N/A	N/A

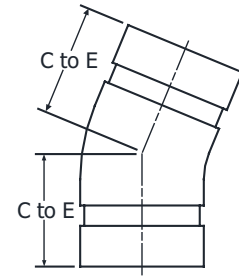

**FP52-22**

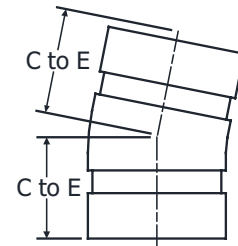

**FP52-11**

### Flow Data (Equivalent feet of pipe)

Size in.	FP52 ft.	FP52-45 ft.
1 1/4	2.3	1.2
1 1/2	2.7	1.3
2	3.4	1.7
2 1/2	4.1	2.1
3	5.1	2.6
4	6.7	3.4
6	10.1	5.1
8	13.3	6.7
10	16.7	8.4



# Model FP52GTF

## Grooved End of Run Adapter Elbows

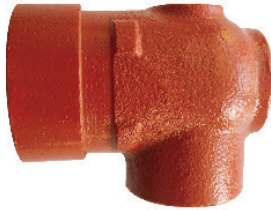
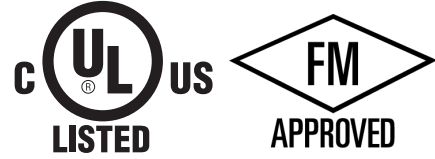

**112X12-FP52GTF**

**Dimensions & Weights (do not include pkg.)**

SIZE in.	MODEL	Dimensions (approximate)		
		A in.	B in.	Wt. lb.
1 1/4 X 1/2	114X12-FP52GTF	1.77	1.20	0.9
1 1/4 X 3/4	114X34-FP52GTF	1.77	1.20	0.9
1 1/4 X 1	114X1-FP52GTF	1.91	1.24	0.9
1 1/2 X 1/2	112X12-FP52GTF	1.77	1.32	0.9
1 1/2 X 3/4	112X34-FP52GTF	1.77	1.32	0.9
1 1/2 X 1	112X1-FP52GTF	1.91	1.32	0.9
2 X 1/2	2X12-FP52GTF	1.75	1.57	1.1
2 X 3/4	2X34-FP52GTF	1.77	1.57	1.1
2 X 1	2X1-FP52GTF	1.91	1.63	1.1
2 1/2 X 3/4	212X34-FP52GTF	1.75	1.75	1.1
2 1/2 X 1	212X1-FP52GTF	1.91	1.81	1.1

