

FLOMATIC® VALVES

High Quality Valves Built To Last...



2021 PRICE LIST

Effective June 14th, 2021 - Rev. 2



**VALVE PRODUCTS FOR MUNICIPAL, WATER WELL,
IRRIGATION, AND INDUSTRIAL APPLICATIONS**

Flomatic is a valve manufacturer certified under ISO 9001-2015 and ISO 14001-2015 quality and environmental systems.



NEW

New Stainless Steel Ball Check Valves 3" through 6" Sizes, AIS Compliant

We introduce new sizes on our Model 408S6 Ball Check Valve that meets AWWA standard C508. The Model 408S6 valve body features an all 316 Stainless Steel body and access port. These valves are designed to meet demanding wastewater lift stations and industrial applications. Now available in 3", 4" and 6" sizes, the Model 408S6 meets the standards as set forth in the "American Iron and Steel Act (AIS)".

[SEE PAGE 13](#)



NEW

Extended AWWA C508 Swing Check Valves New 3" & 10" Sizes, AIS Compliant Model 92

We are proud to announce the expansion of the growing AWWA Swing Check Valve family with the new 3" and 10" American Iron and Steel (AIS) compliant Model 92. The Model 92 Swing Check Valve is now available in a size range of 3" through 10". Additional AIS type valves and sizes from 3" thru 30" for water and wastewater applications are available. The Model 92 is designed in accordance to the AWWA C508 standard.

[SEE PAGE 11](#)



NEW TRAINING CENTER



NEW R&D LAB



NEW

Extended Submersible Pump Check Valves New 10" Size on Model 80DI-VFD

We have expanded our American Iron and Steel (AIS) compliant Model 80DIVFD submersible pump check valve model with a new 10" size. Our new special patented flow efficient submersible pump check valve is now available in a size range of 1" thru 10" for use with variable-frequency drive (VFD) control submersible pumps or conventional systems. Standard check valves may "chatter" and be noisy when a VFD goes to low flow, causing premature wear and eventual failure.

[SEE PAGE 4](#)



NEW

Flow Control Valves Flo-Trol® CD900 New Sizes and GPM's

We have expanded the product offering on our Flo-Trol® automatic flow control valves now from 3/8" through 2" size and flow ranges from 0.25 to 30 GPM.

Designed to give constant flow over a wide pressure range. The valve is designed in a stainless steel construction and has no moving parts; rather a self-cleaning flexible orifice that varies in size with applied pressure so that a constant flow rate is maintained, NSF/ANSI 61 Certified.

[SEE PAGE 27](#)

TABLE OF CONTENTS

VALVES BY TYPE

	AIR RELEASE/ VACUUM	PAGE
	Auto-Drain - Model 70	1
	Auto-Vac® - Model 77	13
	Backflush	32
	Comboair®, Sewair®	31, 32
	Miniair®, Maxiair®, Wellair®	31

	AUTOMATIC CONTROL VALVE	PAGE
	Altitude	
	C201, CF201,	
	C205, CF205	22
	Back Pressure	
	C301, CF301	22
	Cycle Gard® - CB152E, CB152SST	
	C153S6, CI, CN, C152E	29, 30
	Float Valve	
	C701, CF701	23
	Flo-Trol®	27
	Flow Control	
	C901, CF901	24
	Hydraulic Check	
	C1001, CF1001	24
	Pressure Reducing	
	C101, CF101, C150E	22, 28
	Pressure Relief	
	C401, CF401	23
	Pump Control	
	C621	23
	Solenoid Actuated	
	C801-2, CF801-2	24
	Surge Arrestor	
	C501, CF501	23

	BACKFLOW PREVENTERS	PAGE
	Hose Connection Vacuum Breaker	
	GFHB8	33
	Dual Check Valve, GF8080E,	
	GF8080S6	33
	Dual Check Valve w/ Atmos. Vent	
	GF8200	33

	STAINLESS STEEL BALL VALVES	PAGE
	(Quarter Turn)	
	SS Ball Valves	24

	BUTTERFLY VALVES	PAGE
	Azure® AWWA C504	15
	Sylax®3 Wafer & Lug Style	16
	Sylax®3 Butterfly Valves	16
	Sylax®3 Electric Actuated	16

	BREAK-OFF PLUGS	3, 4
	DRAIN-BACK	4

	CHECK VALVES	PAGE
	Auto Drain	1
	Ball Check	
	508, 508S6, 408, 408S6 ,	
	208, 208T/S	13
	Globe Style Silent Check	
	402BT/R/STR, 402S6/R	9,10
	Hydraulic Check	
	C1001, CF1001	24
	Submersible Check	
	80E, 80HTE, 100DPE, 100E,	
	100MEVFD, 100ME	1
	80EVFD, 100EVFD,	
	80AE, 80AEVFD, 80BE, 80BEVFD	
	80CEVFD, 80XBEVFD	2
	80MDW-VFD, 82DI8R-VFD	3
	80DIVFD, 80DI, 80DIX,	
	80DIVFD, 80MDIVFD, 100MDI	
	SLIM LINE®, 82DP, 80DICLVFD	5
	80SS, 100SS, 100SSVFD	
	80SSVFD, 80SSBVFD, 80SSCVFD,	
	80SSXBVFD	6
	80S6, 80S6VFD, 82S6VFD	
	80MS6FD, 100MSS, 100XLSS	7
	80S6CLVFD, 80S6MCLVFD	8
	Swing Check	
	78, 78A, 90/92, 93	11
	745, 745ASC 745BF/PI, 745BFPI	12
	Wafer & SS Check	
	816, 816FL, 816HS	8
	Split Disc®, 888, 888S6	
	812X, 888VFD, 888S6VFD	9, 10

	FOOT VALVES	PAGE
	60SE, 100MP, 333, 190,	
	290P, 297D, 124P, 104	18
	63, 812XTF, 80S6VFD, 302BT,	
	302S6, 333SS, 345, 357	19

	GATE & PLUG VALVES	PAGE
	NRS AWWA C515, C509,	
	OS&Y AWWA C509	34
	Plug Valves	14

	STRAINERS	PAGE
	16, 16FL	20
	6P, 6SS, 46, 46T, 6SE	20
	Y Strainers	20

VALVES BY MATERIAL

CAST IRON	PAGE
Air Release/Vacuum	31, 32
Ball Check	13
Foot Valve	18
Globe Style Silent Check	10
Strainer	20
Swing Check	11
Y-Strainers	20

DUCTILE IRON	PAGE
Butterfly Valve	15, 16
Control Valve	21 - 26
Plug Valves	14
Submersible Check Valves	3 - 5
Swing Checks	11, 12
Wafer Check	10

PLASTIC	PAGE
Ball Check	13
In-line Check	18
Insert Check	18
Foot Valves	18
Strainers	20
Submersible Check	18

STAINLESS STEEL	PAGE
Foot Valve	19
Strainers	20
Submersible Check	6 - 8
Wafer/Globe Check	9

UNLEADED BRONZE	PAGE
Foot Valves	18
In-line Check	1, 2
Strainers	20
Submersible Check	1, 2
Y-Strainers	20

CONDITIONS OF SALE	36
SALES AGENTS	35

Go to www.flomatic.com and type the model number in the search

Product/Site Search 

CONTACT FLOMATIC

Do you need help finding the right product for your application?
Our Customer Service Representatives are ready to help you choose the right valve for you.

CALL 800.833.2040

80E Discount Code **A**



80E - ENVIRO CHECK® body casting unleaded bronze with threaded female connections. This valve features a non-spin acetel (1/2" - 2") or unleaded bronze (2 1/2" - 4") poppet with a NITRILE (Buna-N) seal and a stainless steel spring.

Temp Max: 180 °F (80 °C) Pressure Max: 400 PSI

SIZE	PART NO.	WGT.	CASE QTY.	LIST PRICE
1/4"*	5118E*	.2	10	\$ 77.61
3/8"*	5159E*	.2	10	\$ 78.02
1/2"	4029E	.2	100	\$ 56.77
3/4"	4030E	.7	100	\$ 57.45
1"	4031E	1.3	50	\$ 59.92
1 1/4"	4032E	1.6	36	\$ 83.15
1 1/2"	4033E	2.5	25	\$ 116.00
2"	4034E	3.1	16	\$ 187.00
2 1/2"***	4035E**	6.5		\$ 802.00
3"***	4036E**	13		\$ 969.00
4"***	4037E**	24		\$ 1,677.00

* Pressure Max 200 PSI

** Unleaded bronze poppet, 2 1/2" and larger are recommended for vertical applications. See 80EVFD or 80DI-VFD for Horizontal.

100ME Discount Code **A**



100ME - ENVIRO CHECK® body casting unleaded bronze with threaded male x female connection. Hex shaped body for easy wrenching, this valve features a non-spin acetel poppet with a NITRILE (Buna-N) seal and stainless steel spring.

Temp Max: 180 °F (80 °C) Pressure Max: 400 PSI

SIZE	PART NO.	WGT.	CASE QTY.	LIST PRICE
1 1/4"M x 1"F	4221LE	1.4	50	\$ 63.00
1 1/4"M x 1 1/4"F	4242E	1.5	50	\$ 82.00
1 1/2"M x 1 1/4"F	4223E	1.5	36	\$ 118.00
2"M x 2"F	4079E	2.5	16	\$ 194.00

100DPE Discount Code **A**



100DPE - ENVIRO CHECK® body casting unleaded bronze, dual purpose check valve, stainless steel spring and non-spin acetel poppet. 1 1/4" male and 1" female threads on both ends with a NITRILE (Buna-N) seal.

Temp Max: 180 °F (80 °C) Pressure Max: 400 PSI

SIZE	PART NO.	WGT.	CASE QTY.	LIST PRICE
1 1/4"M & 1"F	4231E	1.1	50	\$ 71.21

100E Discount Code **A**



100E - ENVIRO CHECK® body casting unleaded bronze. Hex shaped body for easy wrenching, this valve features a non-spin acetel poppet with a NITRILE (Buna-N) seal and stainless steel spring.

Temp Max: 180 °F (80 °C) Pressure Max: 400 PSI

SIZE	PART NO.	WGT.	CASE QTY.	LIST PRICE
1"	4201E	1.1	50	\$ 56.83
1"*	4201LE*	1.2	50	\$ 62.75
1 1/4"	4202E	1.4	36	\$ 82.09

* Longer threads



100MEVFD Discount Code **A**



100MEVFD - ENVIRO CHECK® body casting unleaded bronze with threaded male x female connection. The valve features a high strength patented guide, poppet and spring with a NITRILE (Buna-N) seal.

Temp Max: 180 °F (80 °C) Pressure Max: 400 PSI

SIZE	PART NO.	WGT.	CASE QTY.	LIST PRICE
1"M x 1"F	4071EVFD	.7	50	\$ 74.60
1 1/4"M x 1"F	4221EVFD	1.4	50	\$ 74.63
1 1/4"M x 1 1/4"F	4242EVFD	1.5	50	\$ 99.00
1 1/2"M x 1 1/4"F	4223EVFD	1.5	36	\$ 145.00

100XLE Discount Code **A**



100XLE - ENVIRO CHECK® body casting unleaded bronze. Hex shaped body for easy wrenching, this valve features a non-spin acetel poppet with a NITRILE (Buna-N) seal and stainless steel spring. Features extra long threads for bell end special PVC drop pipe.

Temp Max: 180 °F (80 °C) Pressure Max: 400 PSI

SIZE	PART NO.	WGT.	CASE QTY.	LIST PRICE
1"M x 1"F	4201XLE*			DISCONTINUED*
1 1/4"M x 1 1/4"F	4242XLE	2	36	\$ 93.99

*SEE PAGE 7 FOR STAINLESS STEEL VERSION

80HTE Discount Code **A**

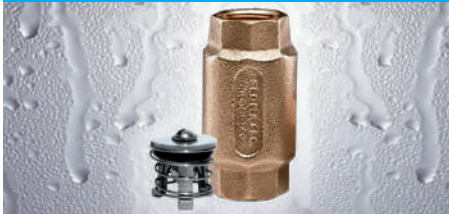

80HTE - ENVIRO CHECK® body casting unleaded bronze with threaded female connections. Features a high temperature stainless steel poppet and a VITON seal with a stainless steel spring. Ideal for hot water applications.

Temp Max: 400 °F (200 °C) Pressure Max: 100 PSI*

SIZE	PART NO.	WGT.	LIST PRICE
3/4"	4030HTE	.8	\$ 108.00
1"	4031HTE	1.4	\$ 109.00
1 1/4"	4032HTE	1.7	\$ 148.00
1 1/2"	4033HTE	2.7	\$ 197.00
2"	4034HTE	4.0	\$ 268.00
2 1/2"	4035HTE	6.5	\$ 892.00
3"	4036HTE	13	\$ 1,058.00
4"	4037HTE	25	\$ 1,928.00

* At high temps the pressure rating is derated to 100 PSI, valve will take higher pressure at lower temps

70 Discount Code **A**



70 - Auto-Drain - This 1" valve is available in stainless steel and PVC. All internal parts are engineered composite with a stainless steel disc and resilient seat.

Temp Max: 180 °F (80 °C) Pressure Max: 400 PSI

5 PSI - open pressure - standard

MATERIAL	PART NO.	CASE QTY.	LIST PRICE
PVC	4501PX	12	\$ 54.00
Stainless	4501SSX	12	\$ 64.00

10 PSI - open pressure - optional

MATERIAL	PART NO.	CASE QTY.	LIST PRICE
PVC	4501P	12	\$ 54.00
Stainless	4501SS	12	\$ 64.00

Note: 10 PSI spring require minimum 5 gpm to close. For lower flows or long horizontal runs use standard 5 PSI.

VISIT OUR WEBSITE AT
WWW.FLOMATIC.COM
OR CALL 800.833.2040

80EVFD/100EVFD Discount Code **A**



80EVFD/100EVFD - ENVIRO CHECK® body casting unleaded bronze with threaded female connections. 80 style has hex on both ends and 100 style has hex on body for easy wrenching. The valve features a high strength patented guide and poppet and spring with a NITRILE (Buna-N) seal.

Temp Max: 180 °F (80 °C) Pressure Max: 400 PSI

SIZE	PART NO.	STYLE	WGT.	CASE QTY.	LIST PRICE
Composite Poppet & Guide					
1"	4201EVFD	100	1	50	\$ 70.91
1"	4031EVFD	80	1	50	\$ 75.00
1 1/4"	4202EVFD	100	1.4	36	\$ 98.86
1 1/4"	4032EVFD	80	1.4	36	\$ 101.00
1 1/2"	4033EVFD	80	2.5	25	\$ 143.00

Stainless Poppet & Composite Guide

1"	4201ESVFD	100	1	50	\$ 70.91
1"	4031ESVFD	80	1	50	\$ 82.00
1 1/4"	4202ESVFD	100	1.4	36	\$ 108.88
1 1/4"	4032ESVFD	80	1.4	36	\$ 112.00
1 1/2"	4033ESVFD	80	2.5	25	\$ 158.00
2"*	4034EVFD*	80	3	16	\$ 229.00
2 1/2"*	4035EVFD*	80	6.5		\$ 972.00

Stainless Poppet & Guide

2"	4034ESVFD	80	3.0	16	\$ 252.00
2 1/2"	4035ESVFD	80	6.5		\$ 1,069.00
3"	4036EVFD	80	13		\$ 1,174.00
4"	4037EVFD	80	24		\$ 2,043.00

*For horizontal installation see 4034ESVFD & 4035ESVFD.

80CEVFD Discount Code **A**



80CEVFD - ENVIRO CHECK® body casting unleaded bronze with threaded female connections. The valve features a high strength patented guide, poppet and spring with a NITRILE (Buna-N) seal. Control center with four tapping; one 1/8" inlet side, two 1/4" outlet sides, one 1/8" outlet side with a brass plug.

Temp Max: 180 °F (80 °C) Pressure Max: 400 PSI

SIZE	PART NO.	WGT.	CASE QTY.	LIST PRICE
1"	4061EVFD	1.2	50	\$ 90.81
1 1/4"	4062EVFD	1.8	36	\$ 118.40
1 1/2"	4063EVFD	2.7	25	\$ 150.58
2"	4064E	3.1	16	\$ 247.14

80AE/80AEVFD Discount Code **A**



80AEVFD - ENVIRO CHECK® body casting unleaded bronze with threaded female connections. The valve features a high strength patented guide, poppet and spring with a NITRILE (Buna-N) seal. This valve has a 1/8" drilled and tapped hole on the inlet side.

Temp Max: 180 °F (80 °C) Pressure Max: 400 PSI

SIZE	PART NO.	WGT.	CASE QTY.	LIST PRICE
1"	4041E	1.2	50	\$ 75.87
1"	4041EVFD	1.2	50	\$ 82.76
1 1/4"	4042E	1.5	36	\$ 101.16
1 1/4"	4042EVFD	1.5	36	\$ 110.35
1 1/2"	4043E	2.4	25	\$ 125.30
1 1/2"	4043EVFD	2.4	25	\$ 136.79
2"	4044E	3	16	\$ 201.16
2 1/2"	4045E	6.4		\$ 933.39
3"	4046E	13		\$ 1,362.16
4"	4047E	25		\$ 1,800.12

80AEVFD with a 1/4" Tapped Hole on the Inlet Side

SIZE	PART NO.	WGT.	CASE QTY.	LIST PRICE
1"	7981E	1.2	50	\$ 75.87
1"	7981EVFD	1.2	50	\$ 82.76
1 1/4"	7983E	1.5	36	\$ 101.16
1 1/4"	7983EVFD	1.5	36	\$ 110.35

80XAEVFD with a 1/4" Tapped Hole on the Outlet Side

SIZE	PART NO.	WGT.	CASE QTY.	LIST PRICE
1"	7982E	1.2	50	\$ 75.87
1"	7982EVFD	1.2	50	\$ 82.76
1 1/4"	7984E	1.5	36	\$ 101.16
1 1/4"	7984EVFD	1.5	36	\$ 110.35

80BE/80BEVFD Discount Code **A**



80BEVFD - ENVIRO CHECK® body casting unleaded bronze with threaded female connections. The valve features a high strength patented guide, poppet and spring with a NITRILE (Buna-N) seal. This valve has two drilled and tapped holes; 1/8" inlet and 1/4" outlet side.

Temp Max: 180 °F (80 °C) Pressure Max: 400 PSI

SIZE	PART NO.	WGT.	CASE QTY.	LIST PRICE
1"	4051E	1	50	\$ 80.47
1"	4051EVFD	1	50	\$ 91.80
1 1/4"	4052E	1.5	36	\$ 99.97
1 1/4"	4052EVFD	1.5	36	\$ 110.68
1 1/2"	4053E	2.3	25	\$ 130.24
1 1/2"	4053EVFD	2.3	25	\$ 142.08
2"	4054E	2.9	16	\$ 204.61
2 1/2"	4055E	6.3		\$ 982.82
3"	4056E	13		\$ 1,386.30
4"	4057E	25		\$ 1,813.91

80BEVFD with 1/4" Tapped Holes on Both Ends

SIZE	PART NO.	WGT.	CASE QTY.	LIST PRICE
1"	7971E	1	50	\$ 80.47
1"	7971EVFD	1	50	\$ 91.80
1 1/4"	7972E	1.5	36	\$ 99.97
1 1/4"	7972EVFD	1.5	36	\$ 110.68
1 1/2"	7973E	2.3	25	\$ 130.24
1 1/2"	7973EVFD	2.3	25	\$ 142.08
2"	7974E	2.9	16	\$ 204.61

80XBVFD Discount Code **A**



80XBVFD - ENVIRO CHECK® body casting unleaded bronze with threaded female connections. The valve features a high strength patented guide, poppet and spring with a NITRILE (Buna-N) seal. This valve has two 1/4" tapped holes on the outlet side for pressure switch and gauge.

Temp Max: 180 °F (80 °C) Pressure Max: 400 PSI

SIZE	PART NO.	WGT.	CASE QTY.	LIST PRICE
1"	7961EVFD	1.2	50	\$ 90.81
1 1/4"	7963EVFD	1.6	36	\$ 118.40
1 1/2"	7964EVFD	2.8	25	\$ 150.58
2"	7965E	3.2	16	\$ 247.14

**LEAD FREE
NSF/ANSI 61**

Flomatic has a complete unleaded valve product line that complies with all low lead laws – Reduction of Lead in Drinking Water Act and NSF/ANSI 61 stringent requirements for equipment that comes in contact with potable water. Most of Flomatic's products in this price book are NSF/ANSI 61 and 372 certified. Please contact Flomatic for a complete listing of current approvals or visit www.flomatic.com/approvals

For SS poppet, add "S" between "E" and "V" of the part number and add 10% to list price.

VFD (Variable Flow Demand) Features & Benefits

- Lower Friction Loss
- Noiseless Operation

- Patented Design
- 5 Year Warranty (Enviro Check®)

- Stainless Steel Internal Optional
- Optional SS or Ductile Iron Body

Flomatic® Standard Thread Type and Valve Model Guide, Based on Thread & Pipe Type

THREAD TYPE (PIPE TYPE)	THREAD STANDARD	FLOMATIC VALVE MODELS
Taper Pipe Thread (Sch. 40 & 80)	NPT - ASME B1.20.1	80E, 80EVFD, 80DI, 80DIVD, 80MDIVFD, 80DICLVFD, 80DIMCLVFD, 82DI, 82DIVFD, 80S6, 80S6VFD, 80MS6VFD, 80S6CLVFD, AND 80S6MCLVFD.
Line Pipe Thread 8 Round (Sch. 40 & 80)	LP - API 5B Table 3	80DI8R-VFD & 80S68R-VFD
External Upset Tubing Threads (API J55 Tubing)	EU - API 5B Table 7	80MDW-VFD & 80DW-VFD
Casing Short Thread (API J55 Tubing)	API 5B Table 1	80MDW-VFD & 80DW-VFD
Casing Long Thread (API J55 Tubing)	API 5B Table 4	80MDW-VFD & 80DW-VFD

Please consult factory with your thread requirements based on your pipe specifications for further information.

API specification 5B 16th Edition - 2019

80MDW-VFD Discount Code A



80MDW-VFD DEEP WELL® 8 Round EU (External-Upset) Tubing - High strength epoxy coated carbon steel body, male inlet x female outlet. Metal to metal seat with stainless steel spring / stem with external upset tubing round threads, EU-API 5B Table 7. Standard with break-off plug.

Consult factory for specifications

Temp Max: 180° F (80° C) Body Pressure Max: 4,400 PSI (API J55 Tubing)

SIZE	PART NO.	WGT.	LIST PRICE
2 3/8"	7937MDW8EUPLG	8	\$1,514.00
2 7/8"	7936MDW8EUPLG	13	\$1,786.00
3 1/2"	7938MDW8EUPLG	20	\$2,061.00
4 1/2"	7939MDW8EUPLG	37	\$3,023.00

NOTE: Consult factory for other thread combinations

80MDW-VFD Discount Code A



80MDW-VFD DEEP WELL® 8 Round Male end short casing x female end long casing threads - High strength epoxy coated carbon steel body, male inlet x female outlet. Metal to metal seat with stainless steel spring and stem with casing round threads. Standard with break-off plug.

Consult factory for specifications

Temp Max: 180° F (80° C) Body Pressure Max: 4,400 PSI (API J55 Tubing)

SIZE	PART NO.	WGT.	LIST PRICE
4 1/2"	79391MDW8SLPLG	40	\$ 3,023.00
5"	79402MDW8SLPLG	34	\$ 3,023.00
5 1/2"	4088MDW8SLPLG	45	\$ 5,771.00
6 5/8"	4089MDW8SLPLG	68	\$ 7,146.00
7"	40903MDW8SLPLG	113	\$11,679.00
7 5/8"	4091MDW8SLPLG	90	\$ 9,619.00
8 5/8"	4092MDW8SLPLG	99	\$13,741.00
9 5/8"	4093MDW8SLPLG	154	\$16,488.00

NOTE: Consult factory for other thread combinations

80DI8R-VFD Discount Code A



80DI8R-VFD 8 Round Line Pipe Threads - High strength epoxy coated ductile iron patented body, poppet and guide with 8 round connection. Features a NITRILE (Buna-N) seal, with stainless steel shaft and a ductile iron poppet. Designed for vertical or horizontal applications.

Consult factory for specifications

Temp Max: 180° F (80° C) Pressure Max: 600 PSI

Line Pipe Thread 8 Round (Sch. 40 & 80) LP-API 5B Table 3

SIZE	PART NO.	WGT.	LIST PRICE
3"	7938-1VFD	16	\$1,256.00
4"	7939-1VFD	47	\$1,361.00
5"	4088-1VFD	49	\$2,233.00
6"	4089-1VFD	70	\$3,072.00
8"	4090-1VFD	99	\$5,271.00

To order break-off plug, add "PLG" to part number and add \$100.00 to list price, \$75.00 added for composite plug installed and add "PPLG" to end of part number

PLEASE NOTE: Model 80MDW-VFD is available in a female by female configuration. Same prices apply. Consult Factory for part number.

80MDW-VFD REPLACEMENT BREAK-OFF PLUG Discount Code A



BREAK-OFF PLUG - Stainless steel construction. Threaded to install into valve. When broken off, riser pipe drains. For use ONLY with Model 80MDW-VFD above.

Temp Max: 180° F (80° C) Pressure Max: 600 PSI

VALVE SIZE	PART NO.	PLUG SIZE	LIST PRICE
2 3/8" & 2 3/8"	76098-2DW	3/8"	\$ 110.00
3 1/2"	76098-3	3/8"	\$ 76.00
4 1/2" & 5"	76098-5DW	3/4"	\$ 180.00
5 1/2" & 7 5/8"	76098-7DW	3/4"	\$ 180.00
8 5/8" & 9 5/8"	76098-9DW	3/4"	\$ 180.00

BREAK-OFF PLUG OPERATION

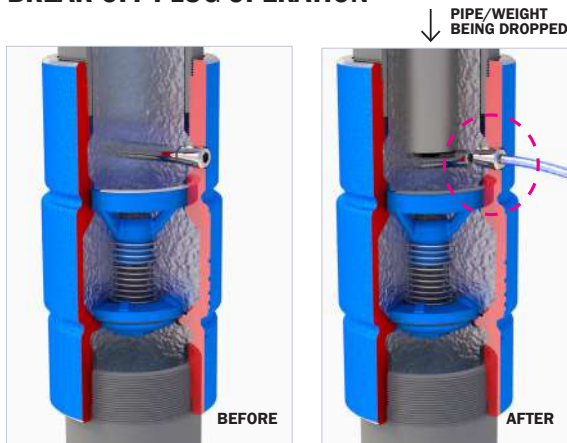

Benefits

- WHEN SERVICING THE PUMP, IT REDUCES THE LIFTING WEIGHT, BY ALLOWING THE WATER TO DRAIN
- ELIMINATES WATER SPLASHING AT SURFACE
- SIMPLY REPLACE THE BREAK-OFF PLUG FOR RE-INSTALLATION

Features

- NO CORROSIVE PARTS
- AVAILABLE FOR SERIES 80DI, 80DI-VFD, 80DIX, 80S6, AND 80S6VFD.
- STANDARD ON SERIES 80MDW-VFD



Exclusive Deep Well Check Valves by Flomatic Valves.

DUCTILE IRON CHECK VALVES 800.833.2040



80DI-VFD - High strength epoxy coated ductile iron patented body, poppet and guide with threaded female NPT connections. Features a NITRILE (Buna-N) seal. Designed for vertical or horizontal applications.

Temp Max: 180°F (80°C) Pressure Max: 600 PSI

SIZE PART NO. WGT. CASE QTY. LIST PRICE

Stainless Poppet & Composite Guide

1"	4031DIVFD	0.8	50	\$ 47.00
1 1/4"	4032DIVFD	1.3	36	\$ 65.00
1 1/2"	4033DIVFD	2.5	25	\$ 92.00
2"	7937VFD*	4	16	\$ 162.00
2 1/2"	7936VFD*	9	1	\$ 391.00

* Not for horizontal installation. See 7937SVFD & 7936SVFD below

Stainless Poppet & Stainless Guide

2"	7937SVFD	4	16	\$ 179.00
2 1/2"	7936SVFD	9	1	\$ 432.00

Stainless Stem & Ductile Iron Poppet and Guide

3"	7938VFD	12	1	\$ 594.00
4"	7939VFD	27	1	\$ 878.00
5"	4088VFD	40	1	\$ 1,648.00
6"	4089VFD	63	1	\$ 1,990.00
8"	4090VFD	87	1	\$ 3,515.00
10"	4091VFD	150	1	\$ 6,050.00

To order break-off plug, add "PLG" to part number and add \$100.00 to list price, \$75.00 added for composite plug installed and add "PPLG" to end of part number



80DI - High strength epoxy coated ductile iron body, disc and follower with threaded female connections. Features a NITRILE (Buna-N) seal, stainless steel spring fasteners, and ductile iron poppet. 2 1/2" and larger are recommended for vertical applications. See 80DIX or VFD design for horizontal.

Note: 1" through 1 1/2" features acetal poppet.

Temp Max: 180°F (80°C)

Pressure Max: 400 PSI 1" - 1 1/2", 600 PSI 2" - 8"

SIZE PART NO. WGT. CASE QTY. LIST PRICE

1"	4031DI	1	50	\$ 39.28
1 1/4"	4032DI	1.6	36	\$ 54.61
1 1/2"	4033DI	2.4	25	\$ 74.63
2"	7937*	4	16	\$ 140.00
2 1/2"	7936	9	1	\$ 332.00
3"	7938	12		\$ 471.00
4"	7939	26		\$ 725.00
5"	4088	46		\$ 1,344.00
6"	4089	61		\$ 1,682.00
8"	4090	93		\$ 2,941.00

* Longer body with stainless steel seat, use break off plug 76098-2.

To order break-off plug, add "PLG" to part number for 2"-8" and add \$100.00 to list price, \$75.00 added for composite plug installed and add "PPLG" to end of part number.



48 - DRAIN-BACK - 1" Drain-Back valve in an all stainless steel construction. Threads to install into a 1" pipe tee. The reusable spring loaded valve is activated when a weight is dropped, draining the riser pipe automatically. Patent Pending.

Temp Max: 180°F (80°C) Pressure Max: 400 PSI

VALVE SIZE PART NO. WEIGHT LIST PRICE

1"	4801SS	1	\$ 83.00
----	--------	---	----------



80DIX - High strength epoxy coated ductile iron body features a double-guided ductile iron poppet. Designed for vertical and horizontal applications.

Temp Max: 180°F (80°C) Pressure Max: 400 PSI

SIZE PART NO. WGT. LIST PRICE

3"	7938DIX	13	\$ 450.00
4"	7939DIX	17	\$ 706.00
6"	4089DIX	51	\$ 1,282.00
8"	4090DIX	89	\$ 3,233.00
10"	4091DIX	150	\$ 5,034.00
12"	4092DIX	350	\$ 10,371.00

To order with break-off plug, replace "DIX" with "XPL" in part number and add \$100.00 to list price of valve, \$75.00 added for composite plug installed and add "XPPLG" to end of part number.

See 80DI or 80DIVFD for high capacity flow.



BREAK-OFF PLUG - Stainless steel construction. Threaded to install into valve. When broken off, riser pipe drains.

Temp Max: 180°F (80°C) Pressure Max: 600 PSI

VALVE SIZE PART NO. PLUG SIZE LIST PRICE

2"	76098-2	1/8"	\$ 73.00
2 1/2"	76098-3	3/8"	\$ 76.00
3"	76098-6	3/8"	\$ 76.00
4"	76098-7	3/8"	\$ 76.00
5", 6"*	76098*	3/8"	\$ 81.00
8"	76098-8	1/2"	\$ 94.00
10" & 12"	76098-11	1/2"	\$ 121.00

*8" size valve was 3/8" plug size prior to 2013.



COMPOSITE BREAK-OFF PLUG - Threaded 3/8" to install into valve. When broken off, riser pipe drains.

Temp Max: 180°F (80°C) Pressure Max: 600 PSI

VALVE SIZE PART NO. PLUG SIZE LIST PRICE

2 1/2" - 6"	76098P	3/8"	\$ 26.40
-------------	--------	------	----------

NOTE: One size fits all, designed for 6" size valves and marked where to cut for smaller valve sizes (2 1/2" & 3", 4").

FLOMATIC® SUBMERSIBLE PUMP CHECK VALVE SERIES 80DI-VFD PATENTED DESIGN

With Stainless Steel Guiding (2" - 10")

Features & Benefits

- VFD Pump Compatible
- 20% - 30% lower Friction Loss
- Noiseless Operation
- Strong Ductile Iron Valve Body (Enviro see page 2) (Stainless see pages 6, 7, 8)
- Corrosion Resistant Internal Components
- Fusion Epoxy Coating - Flo-Coat®
- Longer pipe threads with lead-in section
- Optional 8 round
- Optional "Break-Off" Plug



82DI-VFD Discount Code **A**



82DI-VFD - High strength epoxy coated ductile iron body, poppet and stainless steel guide with threaded male x male connection. Features a NITRILE (Buna-N) seal, stainless steel shaft, and ductile iron poppet. Designed for vertical or horizontal applications.

Temp Max: 180 °F (80 °C) Pressure Max: 600 PSI

SIZE	PART NO.	WGT.	LIST PRICE
2"M x 2"M*	4093VFD*	3	\$ 225.00
2"M x 2"M	4093SVFD	3	\$ 260.00
3"M x 3"M*	4094VFD*	6	\$ 453.00
3"M x 3"M	4094SVFD	6	\$ 498.00
4"M x 4"M	4095VFD	12	\$ 730.00
5"M x 5"M	4096VFD	27	\$ 1,118.00
6"M x 6"M	4097VFD	40	\$ 2,257.00
8"M x 8"M	4098VFD	63	\$ 3,009.00

To order with break-off plug, add "PLG" to part number and add \$ 100.00 to list price of valve, \$75.00 added for composite plug installed and add "PPLG" to end of part number.

* Not for horizontal installation, see 4093SVFD & 4094SVFD.

80SL Slim Line® Discount Code **A**

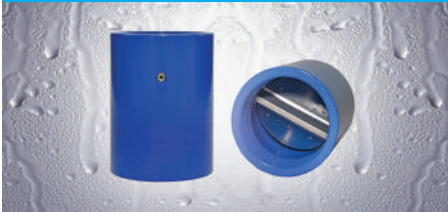

80SL Slim Line® - Carbon Steel epoxy coated threaded valve body with all 316 stainless steel internals. Nitrile nylon seal features a small OD body dimension.

Temp Max: 200 °F (93 °C) Pressure Max: 450 PSI

SIZE	PART NO.	WGT.	LIST PRICE
2"	7937SL	5	\$ 699.00
3"	7938SL	8	\$ 855.00
4"	7939SL	18	\$ 1,314.00
5"	4088SL	21	\$ 2,063.00
6"	4089SL	36	\$ 3,035.00
8"	4090SL	64	\$ 4,993.00

To order with break-off plug, add "PLG" to part number and add \$100.00 to list price of valve

SLIM LINE® - PRODUCT HIGHLIGHTS

- All 316 Stainless Steel Internals
- Lower Friction Loss than Conventional Poppet Style Check Valves
- Compact Design to fit in smaller diameter well casings
- Full Port for Higher Flow and Low Friction Loss
- Optional Break-Off Plug Available

80MDI-VFD Discount Code **A**



80MDI-VFD - High strength epoxy coated ductile iron body, high strength poppet and guide with threaded male x female NPT connection. Features a NITRILE (Buna-N) seal, stainless steel shaft, and ductile iron poppet. Designed for vertical or horizontal applications.

Temp Max: 180 °F (80 °C) Pressure Max: 600 PSI

SIZE	PART NO.	WGT.	LIST PRICE
1 1/4"M x 1"F	4221DIVFD	1	\$ 38.00
1 1/4"M x 1 1/4"F	4242DIVFD	1.2	\$ 53.71
2"M x 2"F*	4084VFD*	4	\$ 250.00
2"M x 2"F	4084SVFD	4	\$ 292.00
3"M x 3"F	4083VFD	14	\$ 497.00
4"M x 4"F	4077VFD	22	\$ 706.00
5"M x 5"F	4075VFD	23	\$ 1,238.00
6"M x 5"F	4087VFD	48	\$ 1,248.00
6"M x 6"F	4081VFD	50	\$ 1,412.00

To order with break-off plug, add "PLG" to part number for 2"-6" and add \$100.00 to list price of valve, \$ 75.00 added for composite plug installed and add "PPLG" to end of part number.

*Not for horizontal installation, see 4084SVFD.

82DP (Replaces 82) Discount Code **A**



82DP - Dual purpose compact ductile iron reduced ported check valve with female and male threads on both ends. High strength ductile iron body and poppet, with stainless steel spring and fasteners. Designed to fit into tight fitting wells.

Temp Max: 180 °F (80 °C) Pressure Max: 400 PSI

SIZE	PART NO.	WGT.	LIST PRICE
2 1/2"F x 3"M*	4094DP*	7	\$ 383.00
3"F x 4"M	4095DP	10	\$ 484.00
4"F x 5"M	4096DP	25	\$ 890.00
5"F x 6"M	4097DP	51	\$ 1,360.00

Same valve as 82, extra female (internal) threads.

Note: RESTRICTED FLOW - REDUCED PORTED, SEE VFD MODEL FOR FULL PORTED, HIGH FLOW DESIGN.

* Unleaded Bronze Poppet

100MDI Discount Code **A**



100MDI - High strength epoxy coated ductile iron valve features male threaded inlet and female threaded outlet. Ideal for submersible pumps.

Temp Max: 180 °F (80 °C) Pressure Max: 400 PSI

SIZE	PART NO.	WGT.	LIST PRICE
1 1/4"M x 1"F	4221LDI	1	\$ 32.00
2"M x 2"F*	4084VFD*	4.5	\$ 250.00

*VFD design. Not for horizontal installation, see 4084SVFD.

80DICLVFD Discount Code **A**



80DICLVFD - Ductile iron check valve incorporates grooved locking Certa-Lok® pipe connections. Fusion epoxy coated inside and out including poppet assembly, this valve is corrosion resistant and unleaded. High strength ductile iron body with stainless steel spring and NITRILE (Buna-N) seal.

Also available in all 316SS, Model 80S6CLVFD. See Page 8

Temp Max: 180 °F (80 °C) Pressure Max: 400 PSI

SIZE	PART NO.	WGT.	LIST PRICE
2"*	7937CLVFD*	2.5	\$ 355.00
2"	7937CLSVFD	2.5	\$ 390.00
3"*	7938CLVFD*	10	\$ 466.00
3"	7938CLSVFD	10	\$ 525.00
4"	7939CLVFD	27	\$ 693.00
5"	4088CLVFD	32	\$ 1,207.00
6"	4089CLVFD	47	\$ 1,768.00
8"	4090CLVFD	90	\$ 2,829.00

80MDICLVFD - Ductile iron check valve uses groove lock type pipe connection on outlet end, and male pipe thread for the inlet connection. Materials are the same as the 80DICLVFD.

SIZE	PART NO.	WGT.	LIST PRICE
2"*	7937MCLVFD*	2.5	\$ 355.00
2"	7937MCLSVFD	2.5	\$ 390.00
3"*	7938MCLVFD*	10	\$ 466.00
3"	7938MCLSVFD	10	\$ 525.00
4"	7939MCLVFD	27	\$ 693.00
5"	4088MCLVFD	32	\$ 1,207.00
6"	4089MCLVFD	47	\$ 1,768.00
8"	4090MCLVFD	90	\$ 2,829.00

To order with break-off plug, add "PLG" to part number and add \$100.00 to list price of valve, \$ 75.00 added for composite plug installed and add "PPLG" to end of part number.

*Not for horizontal installation. See 7937CLSVFD or 7937MCLSVFD, 7938CLSVFD, 7938MCLSVFD.

Certa-Lok® is a registered trademark with NAPCO.

100% Fusion Bonded Epoxy coated with NSF/ANSI 61 approved powder with quality coating operation, Flo-Coat®.

80SS/100SS Discount Code **A**



80SS/100SS - All stainless steel one piece body. Stainless steel spring with a NITRILE (Buna-N) seal. Threaded female x female connections.

Temp Max: 180 °F (80 °C) Pressure Max: 400 PSI

SIZE	PART NO.	STYLE	WGT.	CASE QTY.	LIST PRICE
1"	4031SS2	80	1	50	\$ 60.00
1"	4201SS2	100	1	50	\$ 60.00
1"	4201LSS2	100	1	50	\$ 69.51
1 1/4"	4202SS2	100	2	36	\$ 85.00
1 1/4"	4032SS2	80	2	36	\$ 88.00
1 1/2"	4033SS2	80	2	25	\$ 117.00
2"	4034SS2	80	3	16	\$ 189.00

For SS poppet, add "S" between "2" and "V" of the part number and add 10% to list price.

80SSAVFD Discount Code **A**



80SSAVFD - All stainless steel female x female threaded check valve body features a high strength patented guide with stainless steel spring, delrin poppet and a NITRILE (Buna-N) seal. This valve has a 1/8" drilled and tapped hole on the inlet side.

Temp Max: 180 °F (80 °C) Pressure Max: 400 PSI

80SSAVFD with a 1/8" Tapped Hole on the Inlet Side

SIZE	PART NO.	WGT.	CASE QTY.	LIST PRICE
1"	4041SS2VFD	1.2	50	\$ 91.00
1 1/4"	4042SS2VFD	1.5	36	\$ 123.00
1 1/2"	4043SS2VFD	2.4	25	\$ 161.00
2"	4044SS2*	3	16	\$ 240.00

80SSAVFD with a 1/4" Tapped Hole on the Inlet Side

SIZE	PART NO.	WGT.	CASE QTY.	LIST PRICE
1"	7981SS2VFD	1.2	50	\$ 91.00
1 1/4"	7983SS2VFD	1.5	36	\$ 123.00
1 1/2"	7985SS2VFD	2.4	25	\$ 161.00
2"	7987SS2*	3	16	\$ 240.00

80SSAVFD with a 1/8" Tapped Hole on the Outlet Side

SIZE	PART NO.	WGT.	CASE QTY.	LIST PRICE
1"	8981SS2VFD	1.2	50	\$ 91.00
1 1/4"	8982SS2VFD	1.5	36	\$ 123.00
1 1/2"	8983SS2VFD	2.4	25	\$ 161.00
2"	8984SS2*	3	16	\$ 240.00

80SSXAVFD with a 1/4" Tapped Hole on the Outlet Side

SIZE	PART NO.	WGT.	CASE QTY.	LIST PRICE
1"	7982SS2VFD	1.2	50	\$ 91.00
1 1/4"	7984SS2VFD	1.6	36	\$ 123.00
1 1/2"	7986SS2VFD	2.4	25	\$ 161.00
2"	7988SS2*	3	16	\$ 240.00

*Non VFD design

100SSVFD Discount Code **A**



100SSVFD - All stainless steel female x female threaded valve body features patented VFD design with stainless steel spring, delrin poppet with a NITRILE (Buna-N) seal.

Temp Max: 180 °F (80 °C) Pressure Max: 400 PSI

SIZE	PART NO.	WGT.	CASE QTY.	LIST PRICE
1"	4201SS2VFD	1	50	\$ 71.86
1 1/4"	4202SS2VFD	2	36	\$ 91.00
1 1/2"	4203SS2VFD	2	36	\$ 140.00

For SS poppet, add "S" between "2" and "V" of the part number and add 10% to list price.

80SSBVFD Discount Code **A**



80SSBVFD - All stainless steel female x female threaded check valve body features a high strength patented guide with stainless steel spring, delrin poppet and a NITRILE (Buna-N) seal. This valve has two drilled and tapped holes; 1/8" inlet side and 1/4" outlet side.

Temp Max: 180 °F (80 °C) Pressure Max: 400 PSI

SIZE	PART NO.	WGT.	CASE QTY.	LIST PRICE
1"	4051SS2VFD	1	50	\$ 101.00
1 1/4"	4052SS2VFD	1.5	36	\$ 129.00
1 1/2"	4053SS2VFD	2.3	25	\$ 169.00
2"	4054SS2*	2.9	16	\$ 247.00

80SSBVFD with 1/4" Tapped Holes on Both Ends

SIZE	PART NO.	WGT.	CASE QTY.	LIST PRICE
1"	7971SS2VFD	1	50	\$ 101.00
1 1/4"	7972SS2VFD	1.5	36	\$ 129.00
1 1/2"	7973SS2VFD	2.3	25	\$ 169.00
2"	7974SS2*	2.9	16	\$ 247.00

80SSBVFD with 1/8" Tapped Holes on Both Ends

SIZE	PART NO.	WGT.	CASE QTY.	LIST PRICE
1"	7951SS2VFD	1	50	\$ 101.00
1 1/4"	7952SS2VFD	1.5	36	\$ 129.00
1 1/2"	7953SS2VFD	2.3	25	\$ 169.00
2"	7954SS2*	2.9	16	\$ 247.00

*Non VFD design

80SSXBVFD Discount Code **A**



80SSXBVFD - All stainless steel female x female threaded check valve body features a high strength patented guide with stainless steel spring, delrin poppet and a NITRILE (Buna-N) seal. This valve has two 1/4" tapped holes on the outlet side for pressure switch and gauge.

Temp Max: 180 °F (80 °C) Pressure Max: 400 PSI

SIZE	PART NO.	WGT.	CASE QTY.	LIST PRICE
1"	7961SS2VFD	1.2	50	\$ 107.00
1 1/4"	7963SS2VFD	1.6	36	\$ 138.00
1 1/2"	7964SS2VFD	2.3	25	\$ 180.00

80SSCVFD Discount Code **A**



80SSCVFD - All stainless steel female x female threaded check valve body features patented VFD design with stainless steel spring, delrin poppet and a NITRILE (Buna-N) seal. Control Center with four tapping; one 1/8" inlet side, two 1/4" outlet sides, one 1/8" outlet side with a SS plug.

Temp Max: 180 °F (80 °C) Pressure Max: 400 PSI

SIZE	PART NO.	WGT.	CASE QTY.	LIST PRICE
1"	4061SS2VFD	1.2	50	\$ 107.00
1 1/4"	4062SS2VFD	1.6	36	\$ 138.00

For SS poppet, add "S" between "2" and "V" of the part number and add 10% to list price.

80S6 Discount Code **A**



80S6 - All 316 stainless steel female threaded check valve body. Stainless steel spring, poppet and a Viton seal, (Buna-N) optional.

Temp Max: 400 °F (200 °C) Pressure Max: 450 PSI

SIZE	PART NO.	WGT.	LIST PRICE
1"	4031S6	1.1	\$ 105.00
1 1/4"	4032S6	1.4	\$ 168.00
1 1/2"	4033S6	2.7	\$ 204.00
2"	4034S6	4.0	\$ 297.00
3"	7938S6	10	\$ 1,033.00
4"	7939S6	25	\$ 1,598.00
6"	4089S6	65	\$ 5,198.00
8"	4090XSS	90	\$ 8,129.00
10"	4091XSS	170	\$ 14,493.00

Smaller sizes 3/8", 1/4", 1/2" see page 25

To order Model 80S6 with break-off plug, add "PLG" to part number for 2" - 10" and add \$100.00 to list price on valve above, \$75.00 added for composite plug installed and add "PPLG" to end of part #.

80MS6VFD Discount Code **A**



80MS6VFD - All 316 stainless steel threaded male x female check valve body features patented VFD design with stainless steel spring, poppet and a NITRILE (Buna-N) seal.

Temp Max: 180 °F (80 °C) Pressure Max: 450 PSI

SIZE	PART NO.	WGT.	LIST PRICE
2"M x 2"F	4084S6VFD	5	\$ 487.00
3"M x 3"F	4083S6VFD	13	\$ 1,258.00
4"M x 4"F	4077S6VFD	30	\$ 2,209.00
6"M x 6"F	4081S6VFD	69	\$ 5,830.00

To order Model 80MS6VFD with break-off plug, add "PLG" to part number for 2" - 6" and add \$100.00 to list price on valve above, \$75.00 added for composite plug installed and add "PPLG" to end of part #.



MODEL 80DIVFD (PATENTED)

80S6VFD Discount Code **A**



80S6VFD - All 316 stainless steel female threaded check valve body. Features a patented VFD design with stainless steel spring, poppet and a NITRILE (Buna-N) seal, Viton optional.

Temp Max: 180 °F (80 °C)

Pressure Max: 450 PSI 1" - 1 1/2", 600 PSI 2" - 8"

SIZE	PART NO.	WGT.	LIST PRICE
1"*	4031S6VFD*	1	\$ 123.00
1 1/4"*	4032S6VFD*	1.3	\$ 183.00
1 1/2"*	4033S6VFD*	2.5	\$ 244.00
2"	4034S6VFD	5	\$ 365.00
2 1/2"	7936S6VFD	10	\$ 765.00
3"	7938S6VFD	13	\$ 1,402.00
4"	7939S6VFD	30	\$ 2,039.00
5"	4088S6VFD	42	\$ 3,639.00
6"	4089S6VFD	69	\$ 5,944.00
8"	4090XSSVFD	95	\$ 9,576.00

To order Model 80S6VFD with break-off plug, add "PLG" to part number for 2" - 8" and add \$100.00 to list price on valve above, \$75.00 added for composite plug installed and add "PPLG" to end of part #.

* Composite guide

**OPTIONAL "DRAIN BACK" FEATURE
WITH ORIFICE MACHINED IN POPPET
CONSULT FACTORY**

100MSS Discount Code **A**



100MSS - All stainless steel body, threaded male x female connection. Features a high strength delrin poppet, stainless steel spring with a NITRILE (Buna-N) seal.

Temp Max: 180 °F (80 °C) Pressure Max: 400 PSI

SIZE	PART NO.	WGT.	LIST PRICE
3/4"M x 3/4"F*	4218SS*	100	\$ 109.00
1"M x 1"F	4220SS2VFD	50	\$ 75.08
1 1/4"M x 1"F**	4221LSS2**	50	\$ 61.22
1 1/4"M x 1 1/4"F	4242SS2	50	\$ 76.23
1 1/4"M x 1 1/4"F**	4242LSS2**	50	\$ 77.39

* Made from bar stock, with a viton seal

** Longer Body

82S6VFD Discount Code **A**



82S6VFD - All 316 stainless steel threaded male x female threaded check valve body features patented VFD design with stainless steel spring, poppet and a NITRILE (Buna-N) seal.

Temp Max: 180 °F (80 °C) Pressure Max: 450 PSI

SIZE	PART NO.	WGT.	LIST PRICE
2"M x 2"M	4093S6VFD	4	\$ 1,124.00
3"M x 3"M	4094S6VFD	6	\$ 1,314.00
4"M x 4"M	4095S6VFD	12	\$ 1,638.00
5"M x 5"M	4096S6VFD	27	\$ 2,490.00
6"M x 6"M	4097S6VFD	40	\$ 5,095.00
8"M x 8"M	4098S6VFD	63	\$ 6,792.00

To order Model 82S6VFD with break-off plug, add "PLG" to part number for 3" - 8" and add \$100.00 to list price on valve above, \$75.00 added for composite plug installed and add "PPLG" to end of part #.

100XLSS Discount Code **A**



100XLSS - All stainless steel. Hex shaped for easy wrenching, this valve features a non-spin acetal poppet, with a NITRILE (Buna-N) seal and stainless steel spring. Features extra long threads for special bell end PVC pipe, with threaded male x female connection.

Temp Max: 180 °F (80 °C) Pressure Max: 400 PSI

SIZE	PART NO.	WGT.	CASE QTY.	LIST PRICE
1"M x 1"F	4201XLSS2	1	36	\$ 80.00
1 1/4"M x 1 1/4"F	4242XLSS2	1.5	36	\$ 90.00

100MSSVFD Discount Code **A**



100MSSVFD - All stainless steel male x female threaded check valve body features patented VFD design with stainless steel spring, delrin poppet and a NITRILE (Buna-N) seal.

Temp Max: 180 °F (80 °C) Pressure Max: 400 PSI

Composite Poppet & Guide

SIZE	PART NO.	WGT.	LIST PRICE
1"M x 1"F	4220SS2VFD	50	\$ 75.08
1 1/4"M x 1"F	4221SS2VFD	50	\$ 78.52
1 1/4"M x 1 1/4"F	4242SS2VFD	50	\$ 90.09
1 1/2"M x 1 1/4"F	4223SS2VFD	36	\$ 120.00

STAINLESS STEEL CHECK VALVES 800.833.2040

80S6CLVFD Discount Code **A**



80S6CLVFD - All 316 stainless steel check valve incorporates grooved locking Certa-Lok® pipe connections. Stainless steel inside and out including poppet assembly. High strength stainless steel body and spring with a NITRILE (Buna-N) seal.

Also available in ductile iron. See Page 5.

Temp Max: 180°F (80°C) Pressure Max: 450 PSI

SIZE	PART NO.	WGT.	LIST PRICE
2"	7937S6CLVFD	4	\$ 1,153.00
3"	7938S6CLVFD	10	\$ 1,249.00
4"	7939S6CLVFD	27	\$ 1,637.00
5"	4088S6CLVFD	32	\$ 2,490.00
6"	4089S6CLVFD	47	\$ 5,095.00
8"	4090S6CLVFD	90	\$ 6,792.00

Certa-Lok® is a registered trademark with NAPCO.

To order Model 80S6CLVFD with break-off plug, add "PLG" to part number for 3"- 8" and add \$100.00 to list price on valve above, \$75.00 added for composite plug installed and add "PPLG" to end of part #.

80S6MCLVFD Discount Code **A**



80S6MCLVFD - All 316 stainless steel check valve incorporates grooved locking Certa-Lok® pipe connections, on outlet end and male pipe thread for the inlet connection. Materials are the same as the 80S6CLVFD.

Also available in ductile iron. See Page 5.

Temp Max: 180°F (80°C) Pressure Max: 450 PSI

SIZE	PART NO.	WGT.	LIST PRICE
2"	7937S6MCLVFD	4	\$ 1,153.00
3"	7938S6MCLVFD	10	\$ 1,249.00
4"	7939S6MCLVFD	27	\$ 1,637.00
5"	4088S6MCLVFD	32	\$ 2,490.00
6"	4089S6MCLVFD	47	\$ 5,095.00
8"	4090S6MCLVFD	90	\$ 6,792.00

Certa-Lok® is a registered trademark with NAPCO.

Reverse combination available on the inlet side & male on outlet. To order Model 80S6MCLVFD with break-off plug, add "PLG" to part number for 3"- 8" and add \$100.00 to list price on valve above, \$75.00 added for composite plug installed and add "PPLG" to end of part #.

**VISIT OUR WEBSITE AT
WWW.FLOMATIC.COM
OR CALL 800.833.2040**

HOW TO ORDER WARD VALVE

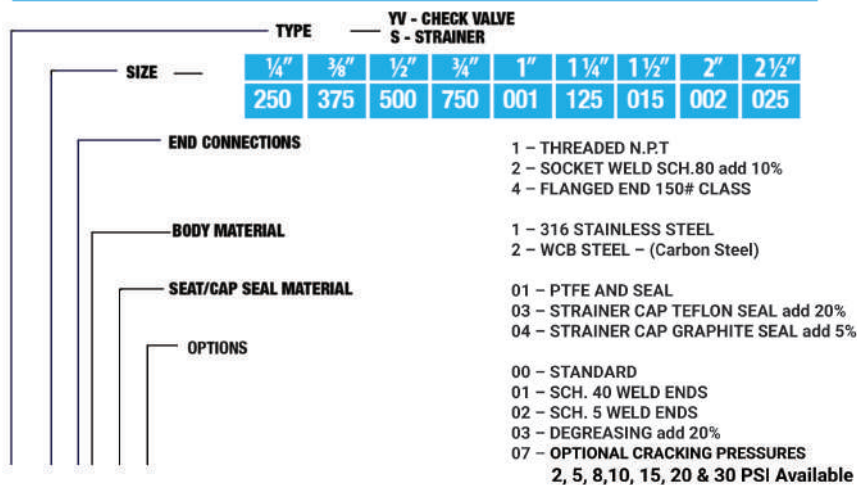

YV - 500-1-1-01

Example above show a 1/2" check valve, NPT threaded, 316SS body with PTFE seat and seal.

816 Discount Code **B**



816 - All 316 stainless steel threaded FNPT "Y-Type" check valve. Patented Spring loaded, Teflon® soft-seated plunger with all 316SS internals.

Temp Max: 450°F (230°C) Pressure Max: 600 PSI
Pressure & temp dependent consult factory

X=1 FOR STAINLESS X=2 FOR CARBON

SIZE	PART NO.	WGT.	STAINLESS LIST PRICE	CARBON LIST PRICE
1/4"	YV2501-X-0100	1	\$ 310.00	\$ 274.00
3/8"	YV3751-X-0100	1	\$ 310.00	\$ 274.00
1/2"	YV5001-X-0100	1	\$ 310.00	\$ 274.00
3/4"	YV7501-X-0100	1	\$ 387.00	\$ 347.00
1"	YV0011-X-0100	2	\$ 435.00	\$ 433.00
1 1/4"	YV1251-X-0100	4	\$ 610.00	\$ 582.00
1 1/2"	YV0151-X-0100	4	\$ 693.00	\$ 605.00
2"	YV0021-X-0100	7	\$ 1,026.00	\$ 928.00

Consult factory for pricing & other end connections and body material options.

WARD VALVES

- ▶ PTFE Seated
- ▶ Low Friction Losses
- ▶ Optional "Cracking" Opening Pressures
- ▶ In-Line Servicable



816FL Discount Code **B**



816FL - All 316 stainless steel flanged "Y-Type" check valve. Patented Spring loaded, Teflon® soft-seated plunger, optional encapsulated spring, with all 316SS internals.

Temp Max: 450°F (230°C) Pressure Max: 600 PSI
Pressure & temp dependent consult factory

X=1 FOR STAINLESS X=2 FOR CARBON

SIZE	PART NO.	WGT.	STAINLESS LIST PRICE	CARBON LIST PRICE
1"	YV0014-X-0100	5.5	\$ 883.00	\$ 822.00
1 1/4"	YV1254-X-0100	8	\$ 1,106.00	\$ 973.00
1 1/2"	YV0154-X-0100	10	\$ 1,309.00	\$ 1,120.00
2"	YV0024-X-0100	15	\$ 1,678.00	N/A

Consult factory for pricing & other sizes and body materials.

816HS Discount Code **B**



816HS - Same body as Model 816 with heavy spring for higher cracking pressure.

Temp Max: 450°F (230°C)* Pressure Max: 600 PSI
Pressure & temp dependent consult factory

SIZE	PART NO.	CRACKING PRESSURE	LIST PRICE
1"	YV001110107-02	2 PSI	\$ 482.00
1"	YV001110107-05	5 PSI	\$ 482.00
1"	YV001110107-08	8 PSI	\$ 482.00
1"	YV001110107-10	10 PSI	\$ 482.00
1"	YV001110107-15	15 PSI	\$ 482.00
1"	YV001110107-20	20 PSI	\$ 482.00
1"	YV001110107-30	30 PSI	\$ 482.00

Additional sizes with optional cracking pressures available consult factory.

*Note: the last 2 digits are the weight of the spring.

812X Discount Code B



812X WAFER STYLE CHECK VALVE - All 316 stainless steel, wafer connection for class 150 and 300 flanges. Metal to metal seating standard, 1 1/2" - 8" available with NITRILE (Buna-N) or VITON seal optional.

Temp Max: -20° F (-30°C) to 660° F (350°C)

Pressure Max: Metal Seating 600 PSI

Consult factory for temp. & pressure rating.

SIZE	PART NO.	WGT.	LIST PRICE
1/2"	2420X	.2	\$ 127
3/4"	2421X	.3	\$ 154
1"	2422X	.5	\$ 176
1 1/4"	2423X	.7	\$ 211
1 1/2"	2424X	1.4	\$ 311
2"	2425X	1.6	\$ 362
2 1/2"	2426X	3.4	\$ 430
3"	2427X	4.8	\$ 601
4"	2428X	7.4	\$ 800
5"	2429X	20	\$ 2,929
6"	2430X	32	\$ 3,361
8"*	2431X*	67	\$ 6,416
8"	2432X	69	\$ 7,497

Note: Add V (Viton) or R (Buna-N) to part #. Consult Factory for pricing.

*230 PSI Max

812XT Discount Code B



812XT - All 316 stainless steel, threaded 3 piece check valve and body. Metal to metal seating, Teflon O-ring, 1 1/2" - 8" available with NITRILE (Buna-N) or VITON seal optional. 2" - 6" available with socket weld connection, add 25% to list, to order replace "T" from the end of part number with "S".

Temp Max: Metal Seating only 400° F (200°C)*

Pressure Max: 300 PSI*

SIZE	PART NO.	WGT.	LIST PRICE
1/2"	2420XT	.9	\$ 160
3/4"	2421XT	1.5	\$ 185
1"	2422XT	2.1	\$ 228
1 1/4"	2423XT	3.5	\$ 345
1 1/2"	2424XT	5.3	\$ 446
2"	2425XT	7.5	\$ 616
2 1/2"	2426XT	19	\$ 759
3"	2427XT	24	\$ 1,103
4"	2428XT	38	\$ 1,830
5"	2429XT	60	\$ 3,286
6"	2430XT	77	\$ 4,671
8**	2431XT**	136	\$ 7,795

Note: Add V (Viton) or R (Buna-N) to part #. Consult Factory for pricing.

*Consult factory for temp. & pressure rating.

**230 PSI Max

Also available with Socket Weld (XS) ends.

Note: For center part replacement consult factory.

888S6R/888S6 Discount Code B



Patented

888S6R/888S6 - All 316 stainless steel silent wafer style check valve, dual rated for class 150 and 300 flanges.

ASME 150#: Max Pressure 275 PSI at 100° F

ASME 300#: Max Pressure 475 PSI at 100° F

Consult factory for pressure rating standards.

888S6R EPDM standard - seal drip tight

SIZE	PART NO.	WGT.	LIST PRICE
2"	2434S6R	5	\$ 549
2 1/2"	2432S6R	7	\$ 636
3"	2435S6R	11	\$ 769
4"	2436S6R	18	\$ 1,054
6"	2437S6R	36	\$ 1,896
8**	2438S6R*	80	\$ 3,353
8**	2438S6R2**	85	\$ 3,887

888S6 optional - Metal to Metal seat not drip tight

SIZE	PART NO.	WGT.	LIST PRICE
2"	2434S6	5	\$ 499
2 1/2"	2432S6	7	\$ 579
3"	2435S6	11	\$ 699
4"	2436S6	18	\$ 958
6"	2437S6	36	\$ 1,724
8**	2438S6*	80	\$ 3,047
8**	2438S6-2**	85	\$ 3,534

Note: 2" - 6" are dual rated to fit between both ASME class 150# & 300# flanges.

*ASME 150# only

**300# Flanged Dimensions

For viton seal consult with factory

COMPACT PATENT DESIGN

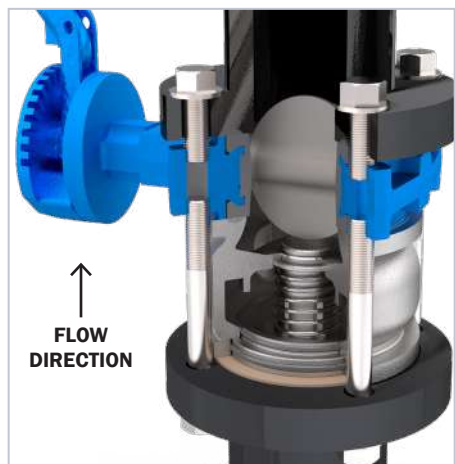

SERIES 888

- ▶ Seat Area Larger than Pipe Diameter
- ▶ No Screws or Fasteners
- ▶ Can be Serviced with Hand Tools
- ▶ Dual Pressure Rating

Above shown with Flomatic Model 888S6VFD and Sylax®3. Wafer check valve close coupled with butterfly valve. Butterfly valve can be operated with check valve in an "open" or "closed" position with no interference.

See page 17 for diagram.

888S6VFD Discount Code B



Patented

888S6VFD - All 316 stainless steel VFD compatible silent wafer style check valve, dual rated for class 150 and 300 flanges.

ASME 150#: Max Pressure 275 PSI at 100° F

ASME 300#: Max Pressure 475 PSI at 100° F

Consult factory for pressure rating standards.

888S6R EPDM standard - seal drip tight

SIZE	PART NO.	WGT.	LIST PRICE
2"	2434S6VFD	4	\$ 603
2 1/2"	2432S6VFD	6	\$ 700
3"	2435S6VFD	9	\$ 845
4"	2436S6VFD	16	\$ 1,158
6"	2437S6VFD	34	\$ 1,965
8**	2438S6VFD*	75	\$ 3,409

Note: 2" - 6" are dual rated to fit between both ASME class 150# & 300# flanges.

* ASME 150# only

LEAD FREE NSF/ANSI 61



Consult factory for complete listing of current NSF/ANSI 61 and 372 approvals OR visit www.flomatic.com/approvals

402S6R/402S6 Discount Code B



Patented

402S6R/402S6 - All 316 stainless steel globe style silent check valve, designed for class 150 flanges.

Max Pressure 275 PSI at 100° F

Consult factory for pressure rating standards.

402S6R EPDM standard - seal drip tight

SIZE	PART NO.	WGT.	LIST PRICE
2"	2239S6R	13	\$ 1,201
2 1/2"	2240S6R	18	\$ 1,454
3"	2241S6R	23	\$ 1,586
4"	2242S6R	40	\$ 2,114
6"	2244S6R	75	\$ 3,832
8"	2245S6R	116	\$ 5,946
12"	2248S6R	306	\$ 17,174

402S6 optional - Metal to Metal seat not drip tight

SIZE	PART NO.	WGT.	LIST PRICE
2"	2239S6	13	\$ 1,093
2 1/2"	2240S6	18	\$ 1,201
3"	2241S6	23	\$ 1,442
4"	2242S6	40	\$ 1,922
6"	2244S6	75	\$ 3,484
8"	2245S6	116	\$ 5,405
12"	2248S6	306	\$ 15,613

Consult factory for additional sizes

402BT/BTR/STR Discount Code **B**



402BT/402BTR/402STR - Epoxy coated ductile iron silent check globe style, body design for use with class 150 flanges. Unleaded bronze metal to metal seating 2" - 12" sizes. Stainless Steel trim and resilient seat standard on 16", 20", 24" sizes (STR Models). Available on other sizes optional, see note below.

Ductile Iron 2" - 12" - Max Pressure 300 PSI at 150 °F
 Ductile Iron 16", 20", 24" - Max Pressure 250 PSI at 150 °F
 Cast Iron 14" & 18" - Max Pressure 150 PSI at 150 °F

Consult factory for pressure rating standards.

Note: For drip tight EPDM seal, add "R" to end of part number and 10% to list price.

SIZE	PART NO.	WGT.	LIST PRICE
2"	2239BT	13	\$ 405
2 1/2"	2240BT	18	\$ 542
3"	2241BT	23	\$ 594
4"	2242BT	40	\$ 781
5"	2243BT	51	\$ 1,366
6"	2244BT	75	\$ 1,262
8"	2245BT	116	\$ 1,984
10"	2247BT	194	\$ 3,061
12"	2248BT	306	\$ 6,056
14"	2249BT	380	POA
16"	2250STR	457	\$ 28,855
18"	2251BT	724	POA
20"	2252STR	750	\$ 35,045
24"	2254STR	1155	\$ 48,852

Note: Optional 316SS seat trim available, Consult factory for pricing.

Consult factory for additional sizes

402BTR2 Discount Code **B**



402BTR2 - Epoxy coated cast iron silent check globe style, body design for use with class 250 flanges. Bronze resilient seating with stainless steel spring (2"-12"), NITRILE (Buna-N) seal, EPDM seat.

Max Pressure 400 PSI at 150 °F
 Consult factory for pressure rating standards.

SIZE	PART NO.	WGT.	LIST PRICE
2 1/2"	2240BTR2	19	\$ 1,542
3"	2241BTR2	25	\$ 1,652
4"	2242BTR2	44	\$ 2,122
5"	2243BTR2	54	\$ 2,703
6"	2244BTR2	80	\$ 3,577
8"	2245BTR2	126	\$ 6,493
10"	2247BTR2	206	\$ 9,240
12"	2248BTR2	400	\$13,725

888R/888 Discount Code **B**



888R/888 - Epoxy coated ductile iron patented silent check, wafer style design with unleaded bronze poppet and seat. Designed to fit between class 150 and 300 flanges.

Note: Optional 316SS seat trim available, add ST to end of part number and 25% to list price. Consult factory.

ASME 150#: Max Pressure 300 PSI at 150 °F
 ASME 300#: Max Pressure 500 PSI at 150 °F
 Consult factory for pressure rating standards.

888R Standard - EPDM drip tight seal

SIZE	PART NO.	WGT.	LIST PRICE
2"	2434R	5	\$ 304
2 1/2"	2432R	7	\$ 345
3"	2435R	11	\$ 362
4"	2436R	18	\$ 485
5"	2433R	25	\$ 857
6"	2437R	36	\$ 923
8"*	2438R*	80	\$ 1,506
10"*	2439R*	129	\$ 2,283

888 optional - Metal to Metal seat not drip tight

SIZE	PART NO.	WGT.	LIST PRICE
2"	2434	5	\$ 281
2 1/2"	2432	7	\$ 310
3"	2435	11	\$ 325
4"	2436	18	\$ 426
5"	2433	25	\$ 766
6"	2437	36	\$ 839
8"*	2438*	80	\$ 1,371
10"*	2439*	129	\$ 2,075

Note: 2" - 6" are dual rated to fit between both ASME class 150# & 300#.

* ASME 150# only

See page 9 for 316SS construction, model 888S6

MODEL 888VFD (PATENTED)



Model 888VFD by Flomatic
 Features/Benefits and Operation

888VFD Discount Code **B**



888VFD - Epoxy coated ductile iron, wafer style, patented VFD design with 316 stainless steel poppet and seat and EPDM seal standard. Designed for class 150 and 300 flanges.

ASME 150#: Max Pressure 300 PSI at 150 °F
 ASME 300#: Max Pressure 500 PSI at 150 °F
 Consult factory for pressure rating standards.

SIZE	PART NO.	WGT.	LIST PRICE
2"	2434VFD	4	\$ 322
2 1/2"	2432VFD	6	\$ 367
3"	2435VFD	9	\$ 380
4"	2436VFD	16	\$ 490
5"	2433VFD	21	\$ 842
6"	2437VFD	34	\$ 914
8"*	2438VFD*	75	\$ 1,608
8"*	2438-2VFD**	75	\$ 2,079
10"*	2439VFD*	131	\$ 2,559

Note: 2" - 6" are dual rated to fit between both ASME class 150# & 300# flanges.

* ASME 150 flange only
 ** 300 Flanged Dimensions

See page 9 for 316SS construction body, model 888S6VFD

895 SPLIT DISC® Discount Code **B**



895 SPLIT DISC® - Cast iron body with epoxy coating and split disc design. Stainless disc with wafer connection class 125 flange 2" - 24" EPDM, PTFE bearing. Stainless steel spring hinge pin. Lifting ring standard above 4".

Temp Max: 180 °F (80 °C) Pressure Max: 200 PSI

SIZE	PART NO.	WGT.	LIST PRICE
2"	3000	3	\$ 233
2 1/2"	3001	4	\$ 270
3"	3002	7	\$ 299
4"	3003	9	\$ 382
5"	3004	22	\$ 615
6"	3005	18	\$ 647
8"	3006	31	\$ 963
10"	3007	49	\$ 1,454
12"	3008	82	\$ 2,185
14"	3009	120	\$ 4,763
16"	3010	170	\$ 5,034
18"	3011	180	\$ 7,915
20"	3012	250	\$ 9,604
24"	3013	360	\$13,905



AIS (American Iron and Steel Act)

Flomatic® offers domestically manufactured valve products that meet the requirements under EPA State Revolving Fund (SRF) for projects in compliance with the American Iron and Steel Act (AIS). Must be specified at time of quote and order.

78 Discount Code **B**



78 - Ductile iron body with epoxy coating. Flanged connection, class 150. Metal reinforced neoprene swing disc, other seals are available that are chemically resistant especially to chloramines. In-line serviceable.

Temp Max: 140 °F (60 °C) Pressure Max: 175 PSI

SIZE	PART NO.	WGT.	LIST PRICE
2 1/2"	2181	35	\$ 614
3"	2182	38	\$ 644
4"	2183	49	\$ 822
6"*	2185*	106	\$ 1,511
8"	2186	172	\$ 2,941

* While supplies last. Part Number is being discontinued .

78A Discount Code **B**



78A - Ductile iron angle body with epoxy coating. Flanged connection, class 150. Metal reinforced neoprene swing disc, other seals are available that are chemically resistant especially to chloramines. In-line serviceable. (Same as ANSI 90° elbow dimension).

Temp Max: 140 °F (60 °C) Pressure Max: 175 PSI

SIZE	PART NO.	WGT.	LIST PRICE
3"	2182A	33	\$ 689
4"	2183A	46	\$ 931
6"	2185A	90	\$ 1,617
8"	2186A	172	\$ 3,086
10"	2187A	335	\$ 7,273
12"	2188A	432	POA

93LW Discount Code **B**



93LW - Swing check valve with outside lever and weight. Epoxy coated cast iron body. Flanged connection, class 125. Bronze trim with stainless steel shaft. Rubber seating standard. Imported, mainly for AG/Irrigation purposes, not municipal.

Temp Max: 180 °F (80 °C) Pressure Max: 200 PSI

SIZE	PART NO.	WGT.	LIST PRICE
2"	2804LW	38	\$ 1,697
3"	2806LW	62	\$ 1,830
4"	2807LW	90	\$ 1,926
6"	2809LW	163	\$ 2,534
8"	2810LW	282	\$ 3,775
10"	2811LW	481	\$ 7,142
12"	2812LW	653	\$10,658



AIS (American Iron and Steel Act)

Flomatic® offers domestically manufactured swing check valve products that meet the requirements under EPA State Revolving Fund (SRF) for projects in compliance with the American Iron and Steel Act (AIS). Must be specified at time of quote and order.

90LS/92LS Discount Code **B**



90LS/92LS - Epoxy coated cast iron body. Meets AWWA C508 specifications. Flanged connection, class 125, with stainless steel shaft. Metal to metal standard or NITRILE (Buna-N) seal (Please add "R" to end of part number) Features external lever and spring.

For vertical installation add "V" to end part number.

Temp Max: 180 °F (80 °C)
Pressure Max: 200 PSI: 2"-12", 150 PSI: 14"-30"

SIZE	PART NO.	WGT.	LIST PRICE
2"	2704LS	36	\$ 3,049
3"	2706LS	62	\$ 3,303
3"*	3706LS*	62	\$ 3,299
4"*	3707LS*	119	\$ 2,195
6"*	3709LS*	205	\$ 3,198
8"*	3710LS*	320	\$ 5,002
8**	3710LS-18**	320	\$ 5,405
10"*	3711LS*	522	\$ 10,194
12"	2712LS	733	\$ 21,347
14"	2714LS	1,150	POA
16"	2716LS	1,630	POA
18"	2718LS	1,835	POA
20"	2720LS	2,500	POA
24"	2724LS	3,415	POA
30"	2730LS	4,950	POA

* 92 Series, 3" consult factory for availability.
** Short Body 18" Face to Face.

90LW/92LW Discount Code **B**



90LW/92LW - Epoxy coated cast iron body. Meets AWWA C508 specifications. Flanged connection, class 125, with stainless steel shaft. Metal to metal standard or NITRILE (Buna-N) seal (Please add "R" to end of part number) Features external lever and weight.

For vertical installation add "V" to end part number.

Temp Max: 180 °F (80 °C)
Pressure Max: 200 PSI: 2"-12", 150 PSI: 14"-30"

SIZE	PART NO.	WGT.	LIST PRICE
2"	2704LW	36	\$ 3,049
3"	2706LW	62	\$ 3,303
3"*	3706LW*	62	\$ 3,299
4"*	3707LW*	125	\$ 2,195
6"*	3709LW*	224	\$ 3,198
8"*	3710LW*	345	\$ 5,002
8**	3710LW-18**	340	\$ 5,405
10"*	3711LW*	522	\$ 10,194
12"	2712LW	733	\$ 21,347
14"	2714LW	1,130	POA
16"	2716LW	1,530	POA
18"	2718LW	1,903	POA
20"	2720LW	2,383	POA
24"	2724LW	3,298	POA
30"	2730LW	5,550	POA

* 92 Series, 3" consult factory for availability.
** Short Body 18" Face to Face.

90CS/92CS Discount Code **B**



90CS/92CS - Epoxy coated cast iron body. Meets AWWA C508 specifications. Flanged connection, class 125, with stainless steel shaft. Metal to metal standard or NITRILE (Buna-N) seal (Please add "R" to end of part number) Features external lever and weight and sealed end cushion system for adjustable rate of valve closure.

For vertical installation add "V" to end part number.

Temp Max: 180 °F (80 °C)
Pressure Max: 200 PSI: 2"-12", 150 PSI: 14"-30"

SIZE	PART NO.	WGT.	LIST PRICE
2"	2704CS	28	\$ 4,014
3"	2706CS	75	\$ 4,488
3"*	3706CS*	75	\$ 3,959
4"*	3707CS*	195	\$ 4,101
6"*	3709CS*	325	\$ 4,786
8"*	3710CS*	355	\$ 6,423
8**	3710CS-18**	355	\$ 6,978
10**	3711CS*	600	\$ 15,389
12"	2712CS	825	\$ 20,967
14"	2714CS	1,150	POA
16"	2716CS	1,630	POA
18"	2718CS	1,953	POA
20"	2720CS	2,470	POA
24"	2724CS	3,415	POA
30"	2730CS	5,610	POA

* 92 Series, 3" consult factory for availability.
** Short Body 18" Face to Face.

Stainless steel seats optional on Model 92 only, add 10% to list price.

*92 series 3", 4", 6", 8", and 10".

All models available with limit switch, add \$700 to list price and add "LS" to end of part #.

SWING CHECK VALVES 800.833.2040

745 Discount Code **B**
AIS COMPLIANT DESIGN



OPTIONAL BODY PLUGS SHOWN

745 - 45° Seat Flo-Flex®, Swing Check Valve epoxy coated Ductile Iron Body, class 150, AWWA C508, with Buna-N coated Disc, and stainless steel cover fasteners. The cover and bottom port are also drilled and tapped with NPT plug.

Optional body bosses drilled and tapped with stainless steel plugs, consult factory.

Temp Max: 140°F (60°C) Pressure Max: 250 PSI

SIZE	PART NO.	WGT.	LIST PRICE
3"	3382	40	\$ 1,064
4"	3383	60	\$ 1,274
6"	3385	103	\$ 2,008
8"	3386	216	\$ 3,288
10"	3387	362	\$ 5,343
12"	3388	628	\$ 7,499



Swing Check Valves by Flomatic Features/Benefits and Operation

745PI/LS Discount Code **B**

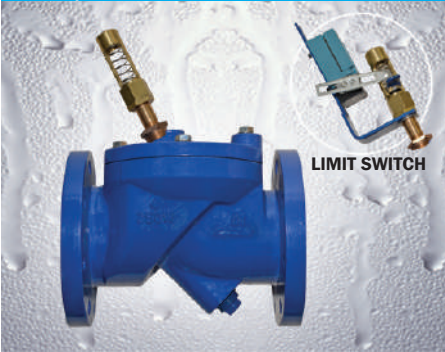

LIMIT SWITCH

745 WITH POSITION INDICATOR - 45° Seat Flo-Flex®, Swing Check Valve epoxy coated Ductile Iron Body, class 150, AWWA C508, with a Buna-N coated Disc.

745LS (Limit Switch) add \$750 to list price below and replace "PI" with "LS" in the part number.

Temp Max: 140°F (60°C) Pressure Max: 250 PSI

SIZE	PART NO.	WGT.	LIST PRICE
3"*	3382PI*	40	\$ 2,269
4"*	3383PI*	68	\$ 2,420
6"*	3385PI*	128	\$ 3,328
8"*	3386PI*	235	\$ 4,567
10"*	3387PI*	380	\$ 6,822
12"*	3388PI*	620	\$ 10,046
14"	2390PI	740	POA
16"	2391PI	1,035	POA
18"	2392PI	1,540	POA
20"	2393PI	1,835	POA
24"	2394PI	2,475	POA

*AIS configuration.

745 Discount Code **B**



745 - 45° Seat Flo-Flex®, Swing Check Valve epoxy coated Ductile Iron Body, class 150, AWWA C508, with Buna-N coated Disc.

Temp Max: 140°F (60°C) Pressure Max: 250 PSI

SIZE	PART NO.	WGT.	LIST PRICE
2"	2380	27	\$ 617
2 1/2"	2381	35	\$ 721
3"	2382	40	\$ 766
4"	2383	68	\$ 910
6"	2385	128	\$ 1,431
8"	2386	235	\$ 2,580
10"	2387	380	\$ 4,110
12"	2388	620	\$ 5,768
14"	2390	740	\$ 8,580
16"	2391	1,035	\$ 11,605
18"	2392	1,540	\$ 13,881
20"	2393	1,835	\$ 17,093
24"	2394	2,475	\$ 25,782

Optional strainer available for foot valve operation.

745BFPI Discount Code **B**



745 WITH BACKFLUSH DEVICE AND POSITION INDICATOR - 45° Seat Flo-Flex®, Swing Check Valve epoxy coated Ductile Iron Body, class 150, AWWA C508, with a Buna-N coated Disc.

Temp Max: 140°F (60°C) Pressure Max: 250 PSI

SIZE	PART NO.	WGT.	LIST PRICE
3"*	3382BFPI*	42	\$ 2,759
4"*	3383BFPI*	71	\$ 3,049
6"*	3385BFPI*	133	\$ 3,958
8"*	3386BFPI*	241	\$ 5,953
10"*	3387BFPI*	402	\$ 9,002
12"*	3388BFPI*	652	\$ 12,632
14"	2390BFPI	774	POA
16"	2391BFPI	1,035	POA
18"	2392BFPI	1,540	POA
20"	2393BFPI	1,835	POA
24"	2394BFPI	2,475	POA

*AIS configuration.

745BF Discount Code **B**



745 WITH BACKFLUSH DEVICE - 45° Seat Flo-Flex®, Swing Check Valve epoxy coated Ductile Iron Body, class 150, AWWA C508, with a Buna-N coated Disc.

Temp Max: 140°F (60°C) Pressure Max: 250 PSI

SIZE	PART NO.	WGT.	LIST PRICE
2"	2380BF	28	\$ 1,251
2 1/2"	2381BF	36	\$ 1,367
3"*	3382BF*	42	\$ 1,670
4"*	3383BF*	71	\$ 1,960
6"*	3385BF*	133	\$ 2,739
8"*	3386BF*	241	\$ 4,538
10"*	3387BF*	402	\$ 7,128
12"*	3388BF*	652	\$ 10,042
14"	2390BF	774	POA
16"	2391BF	1,035	POA
18"	2392BF	1,540	POA
20"	2393BF	1,835	POA
24"	2394BF	2,475	POA

*AIS configuration.

745ASC SURGE-STOPPER® Discount Code **B**
NEW



Patented

745 SURGE-STOPPER® WITH ADJUSTABLE SPRING CLOSURE - 45° Seat Flo-Flex®, Swing Check Valve epoxy coated Ductile Iron Body, class 150, AWWA C508, with a Buna-N coated Disc. Surge-Stopper® is a patented designed for high head, long pipe lines with field adjustable spring assisted closure. AIS configuration.

Temp Max: 140°F (60°C) Pressure Max: 250 PSI

SIZE	PART NO.	WGT.	LIST PRICE
3"	3382ASC	42	\$ 2,616
4"	3383ASC	70	\$ 2,858
6"	3385ASC	130	\$ 3,845

NOTE: Standard adjustable valve cracking pressure is factory set at 2 PSI. Other adjustable ranges are available.

Consult factory for other sizes

Add "S" to end of part number for Stainless Steel fasteners and add 10% to list price. For 2" NPT Stainless Steel tapped plug in cover add -2P to end of part # and \$150 adder. Consult factory for low pressure and/or vacuum applications.

508 Discount Code B



508 - Ductile iron body with epoxy coating. Standard corrosion resistant phenolic "Sinking Ball", with resilient seat, and two bolt access cover. Also available with special "Floating Ball" for flood control or air vent application—consult factory for application and pricing.

Temp Max: 180 °F (80 °C) Pressure Max: 150 PSI

SIZE	PART NO.	WGT.	LIST PRICE
1"	3232	3.5	\$ 210
1 ¼"	3233	4.5	\$ 215
1 ½"	3234	6	\$ 221
2"	3235	8	\$ 260
2 ½"	3236	11.5	\$ 607
3"*	2044*	30	\$ 624
4"**	2045-1**	56	\$ 1,131

*3" has no access cover, quick disconnect valve system.

**Connection is ANSI 125# flanged.

508S6 Discount Code B



508S6 - All 316 Stainless steel body. Standard corrosion resistant phenolic "Sinking Ball", with resilient seat, and two bolt access cover. Also available with special "Floating Ball" for flood control or air vent application—consult factory for application and pricing.

Temp Max: 180 °F (80 °C) Pressure Max: 150 PSI

SIZE	PART NO.	WGT.	LIST PRICE
1 ¼"	3233S6	4.5	\$ 249
1 ½"	3234S6	6	\$ 277
2"	3235S6	8	\$ 310

77 Discount Code B



77 - Auto-Vac® Vacuum Breaker - This 1" valve is available in stainless steel and PVC. All internal parts are engineered composite, with a stainless steel disc and resilient seat. Used to prevent water hammer in wastewater valves.

Temp Max: 180 °F (80 °C) Pressure Max: 400 PSI

MATERIAL	PART NO.	CASE QTY.	LIST PRICE
PVC	4701P	12	\$ 52
Stainless Steel	4701SS	12	\$ 63



Ball Check Valves by Flomatic Features/Benefits and Operation

408² Discount Code B



408² - AIS Compliant ductile iron body with epoxy coating and access port, flanged connection class 150. NITRILE (Buna-N) covered metal sinking ball. Stainless steel fasteners. Also available with special "Floating Ball" for flood control or air vent application—consult factory for application and pricing.

Temp Max: 180 °F (80 °C) Pressure Max: 150 PSI

SIZE	PART NO.	WGT.	LIST PRICE
3"*	2144-2*	37	\$ 743
3"	3144	37	\$ 811
4***	2145-2**	56	\$ 946
4"	3145	56	\$ 1,056
5"*	2143*	85	\$ 1,848
6"	3146	100	\$ 1,914
8"	3147	186	\$ 3,428
10"	3148	315	\$ 8,008
12"	3149	417	\$ 11,256
14"*	2150*	790	POA

* While supplies last. Part # is being discontinued - Non AIS.

** Non AIS compliant.

408²S6 Discount Code B



408²S6 - All 316 Stainless steel body and access port, flanged connection class 150. Nitrile (Buna-N) covered metal sinking ball. Stainless steel fasteners. Also available with special "Floating Ball" for flood control or air vent application—consult factory for application and pricing. Complies with the American Iron and Steel Act, AIS Compliant.

Temp Max: 180 °F (80 °C) Pressure Max: 150 PSI

SIZE	PART NO.	WGT.	LIST PRICE
3"	3144S6	37	\$ 3,420
4"	3145S6	56	\$ 4,404
6"	3146S6	117	\$ 7,281

Consult factory for other sizes.

Ball check valves are recommended for flow velocity of 3' to 5' per sec. For higher flow, consult factory.

208 Discount Code B



208 - Cast iron body with epoxy coating and clean-out port. Threaded female x female connection. Features NITRILE (Buna-N) "Sinking Ball".

Temp Max: 180 °F (80 °C) Pressure Max: 150 PSI

SIZE	PART NO.	WGT.	LIST PRICE
1 ¼"	2141	4.5	\$ 108
1 ½"	2142-0	9.5	\$ 145
2"	2142	9	\$ 145

208T/S Discount Code B



208T/S - Corrosion resistant PVC body. Threaded female x female connection. NITRILE (Buna-N) self-cleaning ball. E-Z access port with NITRILE (Buna-N) seal. Also available with socket weld—change part number from "T" to "S"—same pricing.

Temp Max: 150 °F (65 °C) Pressure Max: 150 PSI

SIZE	PART NO.	WGT.	LIST PRICE
1"	2131T	1	\$ 56
1 ¼"	2132T	1	\$ 59
1 ½"	2133T	2	\$ 91
2"	2134T	2	\$ 91

Note: For BSPP threads, change part number from "T" to "P".

NOT FOR GROUND BURIAL.



Pictured with optional Auto-Vac®, add ".1" to the end of Ball Check part number and \$ 100 to list price. Available on all models.



Remotely monitor ball position (open or close) with this proximity sensor. Add "PRX" to the end of part number. Consult Factory for pricing.

OPTIONAL FLOATING BALL - CONSULT FACTORY

OPERATION OF "THE FLOATING BALL" APPLICATIONS for Model 408FB and 508FB

TO AVOID OVERFLOW OF WATER RISING AND ALSO ALLOW AIR EVACUATION IN FILLING OF TANKS OR PIPES (AIR-VENT).

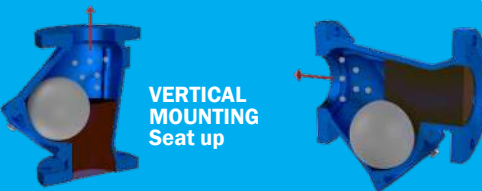

VERTICAL MOUNTING
Seat up

HORIZONTAL MOUNTING

Install the valve with ball access down. The arrow shows the direction in which the liquid is moving.

54-B Discount Code **B**



Flo-E-Centric® Plug Valve with Bare Stem Model 54-B - Class 150 Ductile iron Body ASTM A536 65-45-12. Epoxy Powder, Buna-N Plug, V-Type Packing, Self Lubricating Type 316 Stainless Steel thrust bearing.

Temp Max: 180°F (80°C) Pressure Max: 200 PSI

SIZE	PART NO.	WGT.	LIST PRICE
2" Threaded	54200004B	15	\$ 384
3"	54000006B	40	\$ 723
4"	54000007B	71	\$ 980
6"	54000009B	137	\$ 1,813
8"	54000010B	190	\$ 2,661
10"	54000011B	346	\$ 4,006
12"	54000012B	441	\$ 5,399

54-4 Discount Code **B**



Flo-E-Centric® Plug Valve with 2" AWWA Operating Nut Model 54-4 - Class 150 Ductile iron Body ASTM A536 65-45-12. Epoxy coated, Buna-N Plug, V-Type Packing, Self Lubricating Type 316 Stainless Steel thrust bearing.

Temp Max: 180°F (80°C) Pressure Max: 200 PSI

SIZE	PART NO.	WGT.	LIST PRICE
2" Threaded	542000044	19	\$ 408
3"	540000064	45	\$ 778
4"	540000074	76	\$ 1,013
6"	540000094	142	\$ 1,921
8"	540000104	195	\$ 2,759

HANDLE Discount Code **B**



Flo-E-Centric® Plug Valve Handle for 2" Operating Nut (for Model 54-4 above) - Epoxy coated.

PART NO.	DESCRIPTION	LIST PRICE
1105-50-11	For 2" Valve	\$ 35
1105-200-09	For 3" - 8" Valves	\$ 103



YouTube
Shutoff Valves by Flomatic
Features/Benefits, Selection & Operation

54-0 Discount Code **B**



Flo-E-Centric® Plug Valve with Gear Box Model 54-0 (Direct Mounted) - Class 150 Ductile iron Body ASTM A536 65-45-12. Epoxy coated, Buna-N Plug, V-Type Packing, Self Lubricating Type 316 Stainless Steel thrust bearing.

Temp Max: 180°F (80°C) Pressure Max: 200 PSI

SIZE	PART NO.	WGT.	LIST PRICE
3"	540000060	55	\$ 791
4"	540000070	88	\$ 1,085
6"	540000090	165	\$ 1,920
8"	540000100	256	\$ 2,927
10"	540000110	439	\$ 4,389
12"	540000120	533	\$ 5,313

54-A Discount Code **B**



Flo-E-Centric® Plug Valve w/Actuator - Model 54-0 with 120VAC electric actuator, for open/close service with manual hand-wheel override.

Temp Max: 180°F (80°C) Pressure Max: 200 PSI

SIZE	PART NO.	WGT.	LIST PRICE
2" Threaded	542000040A	42	\$ 2,610
3"	540000060A	78	\$ 3,177
4"	540000070A	120	\$ 4,857
6"	540000090A	188	\$ 6,090
8"	540000100A	322	\$ 8,621
10"	540000110A	478	\$ 9,246
12"	540000120A	573	\$ 10,867

For modulating service add smart card option to list price and "M" to part #. Other options available. Consult Factory. See smart card option on page 16.

Actuator sizing assumes maximum differential pressure of 50 PSI.

54-3 Discount Code **B**



Flo-E-Centric® MJ Plug with buried service gear Series 5400 valves are Ductile iron Body Epoxy coated, Buna-N Plug, V-Type Packing, Self Lubricating Type 316 Stainless Steel thrust bearing. Mechanical joint dimensions complies with AWWA C111..

Temp Max: 180°F (80°C) Pressure Max: 200 PSI

SIZE	PART NO.	WGT.	LIST PRICE
4"	543000087	88	\$ 1,185
6"	543000097	125	\$ 1,993
8"	543000107	200	\$ 2,551
10"	543000117	359	\$ 3,852
12"	543000127	479	\$ 4,915
14"	543000147	581	\$ 7,605
16"	543000167	1082	\$ 9,248
18"	543000187	1300	\$ 12,903
20"	543000207	1828	\$ 18,077
24"	543000247	2271	\$ 29,083



Flo-E-Centric® Plug Valves

- AWWA C517
- Epoxy coated (inside & out)
- Stainless steel thrust bearing
- Spherical BUNA-N coated DI plug
- Ductile iron body: ASTM A536 65-45-12
- 100% full ported (2" to 8")
- Standard ported (10" to 24")
- 98% welded nickel seat
- Stainless steel hardware
- 2" to 8" rated to 200 PSI
- 10" and 12" rated to 175 PSI
- V-type packing

FLANGED BUTTERFLY VALVES AWWA C504



AZURE® MODEL 45 GEAR OPERATED Discount Code B



MODEL 45 (Gear Operated) - Ductile iron flanged body. ASTM A536 ductile iron disc with stainless type 316 edge. Seat standard NBR (EPDM optional) vulcanized. Designed to AWWA standard C504, class 150B. Electric/pneumatic actuation available.

Temp Max: 180°F (80°C) Pressure Max: 200 PSI

SIZE	PART NO.	WGT.	LIST PRICE WITH GEAR
3"	450000060	43	\$ 804
4"	450000070	54	\$ 949
6"	450000090	74	\$ 1,282
8"	450000100	134	\$ 1,632
10"	450000110	188	\$ 2,241
12"	450000120	261	\$ 3,304
14"	450000140	380	\$ 4,923
16"	450000160	414	\$ 6,213
18"	450000180	532	\$ 6,938
20"	450000200	653	\$ 7,371
24"	450000240	739	\$ 11,882

AZURE® MODEL 45 ELECTRIC ACTUATED Discount Code B



MODEL 45 - (Electric Actuated) - Ductile iron flanged body. ASTM A536 ductile iron disc with stainless type 316 edge. Seat standard NBR (EPDM optional) vulcanized. 120VAC on/off electric actuator with manual hand-wheel override for open/close service. Other options available consult factory.

Temp Max: 180°F (80°C) Pressure Max: 200 PSI

SIZE	PART NO.	WGT.	LIST PRICE WITH ACTUATOR
3"	45000006A	61	\$ 3,656
4"	45000007A	72	\$ 3,937
6"	45000009A	82	\$ 5,239
8"	45000010A	165	\$ 6,285
10"	45000011A	220	\$ 7,978
12"	45000012A	300	\$ 9,196
14"	45000014A	530	\$ 10,842
16"	45000016A	564	\$ 15,270
18"	45000018A	686	\$ 19,877
20"	45000020A	823	POA
24"	45000024A	910	POA

Actuator sizing assumes 50 PSI max differential pressure.

For modulating service add smart card option to list price and "M" to part #.

AZURE® MODEL 45 LEVER OPERATED Discount Code B



MODEL 45 (Lever Operated) - Ductile iron flanged body. ASTM A536 ductile iron disc with stainless type 316 edge. Seat standard NBR (EPDM optional) bonded and vulcanized. Designed to AWWA standard C504, class 150B. Electric/pneumatic actuation available.

Temp Max: 180°F (80°C) Pressure Max: 200 PSI

SIZE	PART NO.	WGT.	LIST PRICE WITH LEVER
3"	450000061	43	\$ 759
4"	450000071	54	\$ 870
6"	450000091	74	\$ 1,235

- ▶ Proof of design available upon request
- ▶ Fusion epoxy paint
- ▶ V-type packing
- ▶ Seat Buna-N
- ▶ Meets AWWA C504
- ▶ NSF/ANSI 61 Certified

Butterfly & Plug Valve Options Inquire with Factory

- ▶ Gear Operator
- ▶ Chain-wheel Operator
- ▶ Shaft Extensions
- ▶ Actuation: Electric or Pneumatic

ELECTRIC ACTUATORS

- ▶ 110/120 VAC standard - Inquire for other voltages
- ▶ Battery backup for power loss positioning
- ▶ 'Smart Card' options for valve positioning. (See page 16)
 - ▶ Basic 4-20 mA input and output
 - ▶ Can be configured for 1-5 V, 0-5 V, 0-10 V or digital command
 - ▶ Default setting for loss of command
 - ▶ Feedback
 - ▶ Repeat cycle timer
 - ▶ Log rate control

PNEUMATIC ACTUATORS

- ▶ Double-acting
- ▶ Spring return



SYLAX® 3

Flomatic® SYLAX® 3, Strong DI body, EPDM vulcanized seat, Stainless Steel stem and disc, 250 PSI bi-directional pressure rating, 230 °F max. temperature rating, NSF/ANSI 61 certified, for use with class 125/150# flanges with lockable 10 position handle and ISO 5211 top flange for easy actuation. See page 17 for close coupling with our model 888VFD wafer style check valve (see page 9 & 10).



SYLAX®3 WAFER (SS) Discount Code B



SYLAX®3 LUG (SS) Discount Code B



SYLAX®3 LUG ELECTRIC ACTUATED (SS) Discount Code B



Temp Max: 230 °F (110 °C), Pressure Max: 250 PSI

SYLAX 3 WAFER with LEVER HANDLE			For gear operator add 'G' to part #.	* For 120V on/off actuation add 'A' to part #.
SIZE	PART #	LIST PRICE		
2"	S3W04	\$ 125	\$ 224	\$ 1,770
2 ½"	S3W05	\$ 136	\$ 233	\$ 1,778
3"	S3W06	\$ 154	\$ 265	\$ 1,790
4"	S3W07	\$ 200	\$ 304	\$ 1,873
5"	S3W08	\$ 284	\$ 387	\$ 2,142
6"	S3W09	\$ 339	\$ 420	\$ 2,455
8"	S3W10	\$ 606	\$ 740	\$ 3,020
10"	S3W11	\$ 833	\$ 972	\$ 3,643
12"	S3W12	\$ 1,288	\$ 1,444	\$ 4,358

*Actuator sizing assumes maximum differential pressure of 50 PSI

SYLAX 3 LUG with LEVER HANDLE			For gear operator add 'G' to part #.	* For 120V on/off actuation add 'A' to part #.
SIZE	PART #	LIST PRICE		
2"	S3L04	\$ 165	\$ 270	\$ 1,832
2 ½"	S3L05	\$ 167	\$ 272	\$ 1,840
3"	S3L06	\$ 175	\$ 278	\$ 1,870
4"	S3L07	\$ 238	\$ 337	\$ 1,940
5"	S3L08	\$ 328	\$ 435	\$ 2,536
6"	S3L09	\$ 397	\$ 497	\$ 2,571
8"	S3L10	\$ 776	\$ 936	\$ 3,144
10"	S3L11	\$ 1,057	\$ 1,223	\$ 3,804
12"	S3L12	\$ 1,398	\$ 1,595	\$ 4,604

*Actuator sizing assumes maximum differential pressure of 50 PSI

GEAR OPERATOR Discount Code B



VALVE SIZE	PART NUMBER	LIST PRICE
2 - 4"	149G037000	\$108
5 - 6"	149G037001	\$108
8 - 10"	149G037002	\$182
12"	149G037004	\$222

SMART CARD Discount Code B



SMART CARD - Will fit in Flomatic FCEL Electric Actuator for modulating service, basic 4-20 ma input and output, providing 450 points of resolution. Able to be configured for 1-5 V, 0-5 V, 0-10 V or digital command. Provides default setting upon loss of command. Provides easy setting of open/closed positions for reverse or direct acting without wiring changes.

Pricing adder \$1,815 to install DHC Modulating components in FCEL electric actuator. To order valve with smart card add "M" to the end of valve part number.

Installation of Patented Compact Model 888VFD Wafer Check Valve with Butterfly Valve

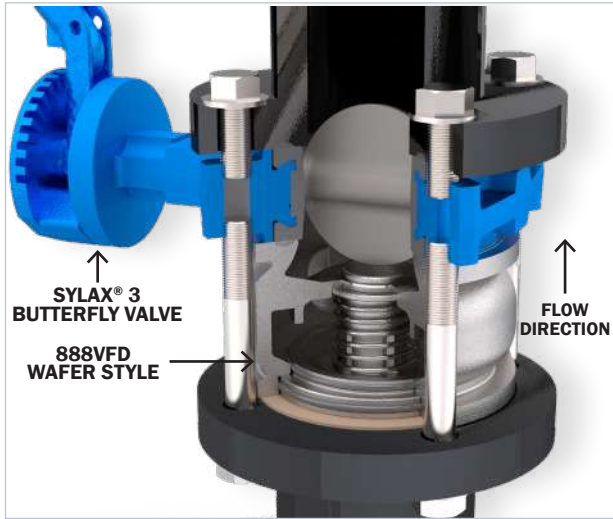

Shown with Flomatic® Model 888S6VFD wafer check valve close coupled with Sylox®3 butterfly valve. Butterfly valve can be operated with check valve in an “open” or “closed” position with no interference.

The patented Flomatic® Model 888VFD Wafer Check Valves can be close coupled with a Butterfly valve without a spool piece (see page 9 & 10).

The Butterfly valve can be operated with the check valve in an “open” or “closed” position with no interference in 2” thru 6” sizes. The overall installation length is much shorter than a traditional combination of a wafer style check valve, butterfly valve, and spool piece.

A traditional Wafer Check valve cannot be close coupled with a Butterfly valve without a spacer or spool piece, longer bolts and additional flange gasket. This spool piece adds weight, takes up more space, parts and installation expense.

Traditional Installation

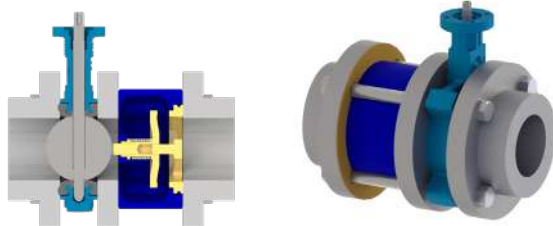

New Patented Compact Design (No Spool Piece Needed)

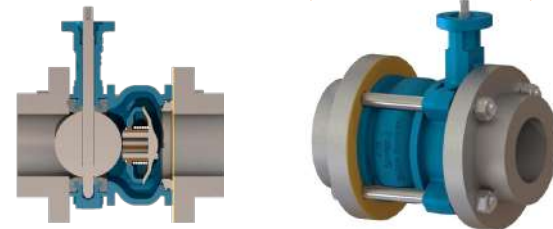

YouTube search: **FLOMATIC VFD**
 Model 888VFD by Flomatic
 Features/Benefits and Operation



Consult factory for complete listing of current NSF/ANSI 61 and 372 approvals

OR visit www.flomatic.com/approvals

BOLT CHART: Dimensions (Direct Mounting to Sylox Lug Style Butterfly Valve)

SIZE		PART NUMBER	# OF BOLTS	BOLT SIZE	LENGTH OF BOLT (INLET)	LENGTH OF BOLT (OUTLET)
INCH	MM					
2"	50	2434VFD	4	5/8"-11	4 1/2"	1 5/8"
2 1/2"	65	2432VFD	4	5/8"-11	4 3/4"	1 7/8"
3"	75	2435VFD	4	5/8"-11	5"	1 7/8"
4"	100	2436VFD	8	5/8"-11	6"	2"
5"	125	2433VFD	8	3/4"-10	6 3/4"	2"
6"	150	2437VFD	8	3/4"-10	7 1/2"	2 1/4"

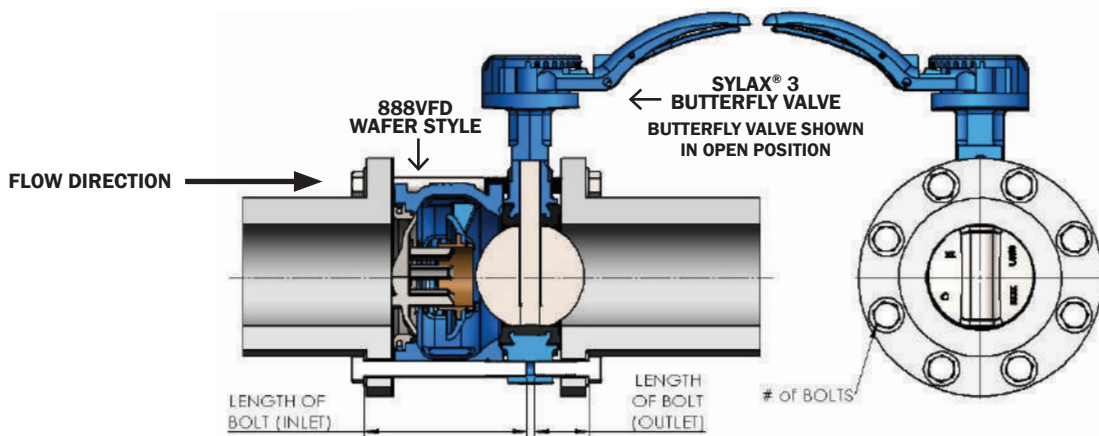

60SE Discount Code A



60SE-ENVIRO FOOT VALVE - body with threaded female connection. Features a NITRILE (Buna-N) seal, acetal poppet (2½", 3" and 4" have bronze poppets) stainless steel spring and strainer.

Temp Max: 180 °F (80 °C)
Pressure Max: 250 PSI (½" size 150 PSI)

SIZE	PART NO.	WGT.	CASE QTY.	LIST PRICE
½"*	5820E*	.1	100	\$ 53.39
¾"	4100E	.3	100	\$ 52.11
1"	4101E	.8	50	\$ 54.98
1 ¼"***	4102E**	.8	50	\$ 65.99
1 ½"	4103E	1	36	\$ 68.00
1 ¾"	4104E	1.6	25	\$ 108.00
2"	4105E	2.1	16	\$ 171.00
2 ½"	4106E	6		\$ 566.00
3"	4107E	11		\$ 779.00
4"	4108E	19		\$ 1,300.00

*Polyethylene strainer

**Model 600S (4102E) will pass through a 2" pipe.

For high temperature: add HTE to the end of part # and 25% to list.

190D/193D/190P Discount Code A



190D - Acetal body and strainer, Nylon 11 poppet. Stainless steel spring and NITRILE (Buna-N) seal.

193D - Similar to the 190D with one-piece acetal body and strainer.

190P - Polypropylene body and strainer. Stainless steel spring and VITON seal.

Temp Max: 140 °F (60 °C) Pressure Max: 150 PSI

SIZE	PART NO.	MODEL	WGT.	CASE QTY.	LIST PRICE
¾"	5619	193D	.03	10	\$ 22.49
¾"	5726	190P	.03	10	\$ 22.49
½"	5620	193D	.03	10	\$ 38.73
¾"	5728	190P	.08	10	\$ 43.72
1 ½"	5724	190D	.28	6	\$ 48.72
2"	5725	190D	.41	6	\$ 111.17

901 Discount Code A



901 - Non-corrosive acetal check valve body and guide. Insert connection. Features NITRILE (Buna-N) seal and stainless steel spring.

Temp Max: 180 °F (80 °C) Pressure Max: 150 PSI

SIZE	PART NO.	WGT.	LIST PRICE
¾"	2011	.1	\$ 11.90
½"	2000	.18	\$ 12.46
¾"	2001	.35	\$ 12.61
1"	2030	.5	\$ 20.22

333E Discount Code A



333E-ENVIRO FOOT VALVE - body with high strength acetal poppet. Tapered stainless steel strainer, end cap, spring and fasteners. NITRILE (Buna-N) seal.

Temp Max: 180 °F (80 °C) Pressure Max: 250 PSI

SIZE	PART NO.	WGT.	CASE QTY.	LIST PRICE
1"	4171E	.6	50	\$ 70.71
1 ¼"	4172E	.8	36	\$ 82.77

100MP Discount Code A



100MP - High-strength Noryl® GTX 830 Body with NITRILE (Buna-N) seal and polypropylene follower. Threaded male x female connection.

Temp Max: 150 °F (65 °C) Pressure Max: 300 PSI

SIZE	PART NO.	CASE QTY.	LIST PRICE
1 ¼" M x 1" F	4221MP	49	\$ 27.89
1 ¼" M x 1 ¼" F	4242MP	49	\$ 30.32

Bulk pricing available.

104P Discount Code A



104P - Reinforced nylon body with threaded female connection. Polyethylene strainer, polyethylene/acetal poppet. NITRILE (Buna-N) seal and stainless steel spring.

Temp Max: 150 °F (65°C) Pressure Max: 150 PSI

SIZE	PART NO.	WGT.	CASE QTY.	LIST PRICE
1"	5732	.13	50	\$ 27.36
1 ¼"	5733	.21	36	\$ 33.31

333DPE Discount Code A



333DPE-ENVIRO FOOT VALVE - body, but with dual purpose male and female threads.

Temp Max: 180 °F (80 °C) Pressure Max: 250 PSI

SIZE	PART NO.	WGT.	CASE QTY.	LIST PRICE
1 ¼" M x 1" F	4181E	.5	50	\$ 77.37
1 ½" M x 1 ¼" F	4182E	.8	36	\$ 87.86

124P Discount Code A



124P- FOOT VALVE - features a simple flow through design with corrosion resistant parts and feature a tapered composite strainer and poppet.

Temp Max: 140 °F (60 °C) Pressure Max: 150 PSI

SIZE	PART NO.	WGT.	LIST PRICE
1" - 1 ¼"*	5728PI*	.24	\$ 26.17
¾" - 1 ½"***	5728P**	.31	\$ 29.74
2" Female	5735P	.25	\$ 48.78

* 2 in 1 combo barbed insert 1" & 1¼"

** 4 in 1 combo, male NPT threads ¾" - 1¼"

297D/290P Discount Code A



The 297D - is an acetal body check valve. Threaded female x female construction. Features a VITON seal, Nylon 11 poppet and stainless steel spring.

Temp Max: 180 °F (80 °C) Pressure Max: 150 PSI

SIZE	PART NO.	WGT.	LIST PRICE
¾"	5359	.04	\$ 32.72
½"	5239	.06	\$ 42.83

The 290P is a Polypropylene body check valve and poppet with stainless steel spring and VITON seal.

SIZE	PART NO.	WGT.	LIST PRICE
½"	5357	.06	\$ 44.02
¾"	5358	.06	\$ 53.53

PRODUCT APPLICATION 901

Insert connection used in conjunction with a water meter when protection from contamination is required

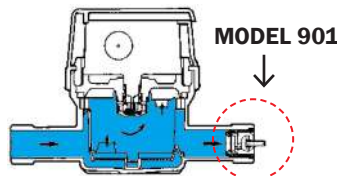

WATER METER

302BT Discount Code **B**



302BT - Epoxy coated ductile iron, foot valve with a globe style body design for use with class 150 flanges. Unleaded bronze trim with an EPDM seal and 316 stainless steel strainer for 2" - 12" sizes. Stainless Steel trim and resilient seat standard on 16", 20", 24" sizes (ST Models). Available on other sizes optional. See note below.

Ductile Iron 2" - 12" - Max Pressure 300 PSI at 150 °F
 Ductile Iron 16", 20", 24" - Max Pressure 250 PSI at 150 °F
 Cast Iron 14", 18" Max Pressure 150 PSI at 150 °F

Consult factory for pressure rating standards.

SIZE	PART NO.	WGT.	LIST PRICE
2"	4763BT	23	\$ 1,131
2 1/2"	4768BT	30	\$ 1,143
3"	4769BT	37	\$ 1,189
4"	4770BT	63	\$ 1,438
5"	4771BT	80	\$ 1,944
6"	4772BT	100	\$ 2,188
8"	4774BT	160	\$ 3,196
10"	4775BT	260	\$ 4,606
12"	5416BT	410	\$ 6,955
14"	5417BT	500	POA
16"	5418ST	650	\$ 31,474
18"	5419BT	850	POA
20"	5420ST	1050	\$ 38,713
24"	5422ST	1440	\$ 58,212

Consult factory for additional sizes

**VISIT OUR WEBSITE AT
 WWW.FLOMATIC.COM
 OR CALL 800.833.2040**

345 Discount Code **B**



345 - 45° Seat Flo-Flex®, Swing Foot Valve Epoxy coated Ductile Iron Body, class 150, with Buna-N coated Disc, stainless steel fasteners, with an all 316 stainless steel strainer. The cover and bottom port are also drilled and tapped with NPT plug. Vertical flow up only.

Temp Max: 140 °F (60 °C) Pressure Max: 250 PSI

SIZE	PART NO.	WGT.	LIST PRICE
3"	3382F	40	\$ 1,753
4"	3383F	60	\$ 1,837
6"	3385F	103	\$ 2,303
8"	3386F	216	\$ 4,769
10"*	3387F*	362	\$ 7,404
12"*	3388F*	628	\$ 10,809

* Consult factory for availability

302S6 Discount Code **B**



302S6 - All 316 stainless steel body, foot valve with a globe style body design for use with class 150 flanges. Features an EPDM seal and a 316 stainless steel strainer.

Max Pressure 275 PSI at 100 °F
 Consult factory for pressure rating standards.

SIZE	PART NO.	WGT.	LIST PRICE
2"	4763S6	23	\$ 1,768
2 1/2"	4768S6	30	\$ 2,002
3"	4769S6	37	\$ 2,078
4"	4770S6	63	\$ 2,699
6"	4772S6	100	\$ 4,360
8"	4774S6	160	\$ 7,162
12"	5416S6	410	\$ 19,985

812XTF Discount Code **B**



812XTF - All 316 stainless steel, threaded female connection. Metal to metal seating and Teflon O-ring.

2" - 4" available with socket weld connection. Consult factory for pricing.

* Temp Max: 400 °F (200 °C) * Pressure Max: 300 PSI

SIZE	PART NO.	WGT.	LIST PRICE
1/2"	2420XTF	2	\$ 395
3/4"	2421XTF	4	\$ 450
1"	2422XTF	5	\$ 637
1 1/4"	2423XTF	9	\$ 776
1 1/2"	2424XTF	12	\$ 860
2"	2425XTF	14	\$ 1,023
2 1/2"	2426XTF	14	\$ 1,789
3"	2427XTF	25	\$ 2,060
4"	2428XTF	39	\$ 2,345
5"	2429XTF	62	\$ 4,994
6"	2430XTF	80	\$ 5,947
8"	2431XTF	140	\$ 10,395

* Consult factory for temp. & pressure rating.

357 Discount Code **A**



357 - Cast iron body and strainer. Threaded female connection. Hinged leather seat.

Temp Max: 80 °F (27 °C) Pressure Max: 20 PSI

SIZE	PART NO.	WGT.	LIST PRICE
1 1/4"	4962	3	\$ 289
1 1/2"	4963	3	\$ 292
2"	4964	6	\$ 303
3"	4966	13	\$ 465
4"	4967	20	\$ 640
6"	4969	45	\$ 1,082
8"	4970	99	\$ 2,365

80S6FVFD Discount Code **A**



80S6FVFD - All 316 stainless steel body threaded foot valve. Stainless steel spring, poppet, strainer and Buna-N seal, Viton optional.

Temp Max: 180 °F (80 °C) Pressure Max: 400 PSI

SIZE	PART NO.	WGT.	LIST PRICE
1"	4031S6FVFD	2.1	\$ 318
1 1/4"	4032S6FVFD	2.4	\$ 429
1 1/2"	4033S6FVFD	5.0	\$ 453
2"	4034S6FVFD	7.0	\$ 699
3"	7938S6FVFD	15	\$ 1,785
4"	7939S6FVFD	30	\$ 2,880
6"	4089S6FVFD	75	\$ 8,170
8"	4090XSSFVFD	105	\$ 10,504
10"	4091XSSF	190	\$ 18,813

333SS Discount Code **A**



333SS- FOOT VALVE - All 303 Stainless steel body with high strength acetal poppet. Tapered stainless steel strainer, end cap, spring and fasteners. NITRILE (Buna-N) seal.

Temp Max: 180 °F (80 °C) Pressure Max: 250 PSI

SIZE	PART NO.	WGT.	CASE QTY.	LIST PRICE
1"	4171SS	.6	50	\$ 155
1 1/4"	4172SS	.8	36	\$ 173

63 Discount Code **B**



63 - Cast iron body with epoxy coating. Features threaded female connection. NITRILE (Buna-N) seal, high strength non-metallic or unleaded bronze or ductile iron poppet, stainless steel spring. Heavy duty polyethylene strainer.

Temp Max: 180 °F (80 °C) Pressure Max: 250 PSI

SIZE	PART NO.	WGT.	LIST PRICE
2"*	4764*	4	\$ 132
2 1/2"	4765	5	\$ 183
3"	4766	9	\$ 228
4"	4767	17	\$ 281
6"**	4789VFD**	36	\$ 1,153

*2" Acetal guide.

** Galvanized Strainer Only.

2 1/2" - Unleaded bronze guide. 3" - 6" Ductile iron poppet. For Municipal applications see 302BT or 302S6 below

16FL STRAINER Discount Code **B**



16FL STRAINER - All 316 Stainless steel body, flanged with 316SS internal strainer. Standard 20 mesh replacement screens optional 40, 60, 80 and 100 mesh screens (fit inside of 20 mesh). Class 150.

Standard 20 Mesh - if optional 40, 60, 80, or 100 add to end of part number:

40 Mesh = 040 to end of part number
60 Mesh = 060 to end of part number
80 Mesh = 080 to end of part number
100 Mesh = 100 to end of part number

X in part # below 1 for stainless steel and 2 for carbon

Temp Max: 800 °F Pressure Max: 600 PSI

SIZE	PART NO.	STAINLESS LIST PRICE	CARBON LIST PRICE
1"	S0014-X-0300	\$ 570	\$ 559
1 1/2"	S0154-X-0300	\$ 1,011	\$ 991
2"	S0024-X-0300	\$ 1,280	\$ 1,255

Strainers supplied with FNPT tapped retainer cap for blow off outlet.

Strainers supplied with PTFE cap seal.

Optional graphite cap seal add: \$15.00

6SE STRAINER Discount Code **A**



6SE STRAINER - Unlead bronze body with threaded female connection. Stainless steel strainer with unlead bronze. Stainless steel or plastic caps.

SIZE	PART NO.	WGT.	CASE QTY.	LIST PRICE
1/2"	4399E	.1	10	\$ 37
3/4"	4300E	.2	100	\$ 51
1"	4301E	.6	49	\$ 74
1 1/4"	4302E *	.6	36	\$ 97
1 1/2"	4303E *	1.2	25	\$ 100
2"	4304E *	2.4	16	\$ 136
2 1/2"	4305E	3		\$ 348
3"	4306E	7.2		\$ 512
4"	4307E	14		\$ 979

* End caps on strainer are composite.

6SS STRAINER Discount Code **A**



6SS STRAINER - All 303 stainless steel body with threaded female connection. Stainless steel strainer with stainless steel or plastic caps.

SIZE	PART NO.	WGT.	CASE QTY.	LIST PRICE
1"	4371SS	.6	49	\$ 176
1 1/4"	4372SS	.6	36	\$ 198

16 STRAINER Discount Code **B**



16 STRAINER - All 316 Stainless steel body, threaded FNPT "Y-Type" strainer. Standard 20 mesh replaceable screens optional 40, 60, 80 and 100 mesh screens (fit inside of 20 mesh). Class 600.

Standard 20 Mesh - if optional 40, 60, 80, or 100 add to end of part number:

40 Mesh = 040 to end of part number
60 Mesh = 060 to end of part number
80 Mesh = 080 to end of part number
100 Mesh = 100 to end of part number

X in part # below 1 for stainless steel and 2 for carbon

Temp Max: 800 °F Pressure Max: 600 PSI

SIZE	PART NO.	STAINLESS LIST PRICE	CARBON LIST PRICE
1/4"	S2501-X-0300	\$ 314	\$ 285
3/8"	S3751-X-0300	\$ 314	\$ 285
1/2"	S5001-X-0300	\$ 314	\$ 285
3/4"	S7501-X-0300	\$ 314	\$ 285
1"	S0011-X-0300	\$ 362	\$ 362
1 1/4"	S1251-X-0300	\$ 436	\$ 394
1 1/2"	S0151-X-0300	\$ 664	\$ 483
2"	S0021-X-0300	\$ 890	\$ 515

Strainers supplied with FNPT tapped retainer cap for blow off outlet.

Strainers supplied with PTFE cap seal. Optional graphite list price cap seal adder: \$15.00 Many different types of configurations available.

46 STRAINER Discount Code **B**



46 STRAINER - Cast iron body with epoxy coating. Flanged connection ANSI 125. Plastic 2"-4" 316 Stainless steel 5"-24" strainer.

SIZE	PART NO.	WGT.	LIST PRICE
2"	5814P	4.7	\$ 212
2 1/2"	5815P	6.4	\$ 216
3"	5816P	8.8	\$ 283
4"	5817P	13	\$ 450

S: Stainless steel screen 5" - 24"

SIZE	PART NO.	WGT.	LIST PRICE
5"	5821S	16	\$ 595
6"	5822S	21	\$ 641
8"	5824S	44	\$ 963
10"	5825S	55	\$ 1,749
12"	5826S	80	\$ 2,099
14"	5827S	121	\$ 3,498
16"	5828S	166	\$ 4,215
18"	5829S	211	\$ 5,195
20"	5830S	256	\$ 5,524
24"	5832S	346	\$ 7,366

6P STRAINER Discount Code **A**



6P STRAINER - Plastic (polyethylene) with male NPT threads. Converts a check valve to a foot valve, by screwing into the valve threads.

Temp Max: 180 °F (80 °C)

STRAINER ONLY

SIZE	PART NO.	WGT.	CASE QTY.	LIST PRICE
3/4"	4300P	.1	25	\$ 8
1"	4301P	.1	25	\$ 8
1 1/4"	4302P	.2	25	\$ 9
1 1/2"	4303P	.3	10	\$ 9

46T STRAINER Discount Code **B**



46T STRAINER - Cast iron body with epoxy coating. Threaded female connection. Removable polyethylene strainer. (Cutaway picture shown).

Temp Max: 180 °F (80 °C)

SIZE	PART NO.	WGT.	CASE QTY.	LIST PRICE
2"	4364	2.5	25	\$ 109
2 1/2"	4365	4	25	\$ 175
3"	4366	8.2	25	\$ 186
4"	4367	14	10	\$ 252

Y-STRAINER Discount Code **C**



Y-STRAINER - Threaded unlead Bronze body (3/8"-2"), 125# cast iron and flanged (2 1/2"-12"), 20 mesh stainless steel strainer. Furnished with clean out plug.

Temp Max: 180 °F

Pressure Max: 200 PSI (2 1/2"-12")
Pressure Max: 400 PSI (3/8"-2")

SIZE	PART NO.	WGT.	LIST PRICE
3/8"	8711E	.5	\$ 43
1/2"	8712E	.3	\$ 45
3/4"	8713E	2	\$ 74
1"	8714E	4	\$ 91
1 1/4"	87142E	5	\$ 153
1 1/2"	87143E	6	\$ 200
2"	87144E	9	\$ 345
2 1/2"	87145	15	\$ 549
3"	87146	25	\$ 649
4"	87147	95	\$ 1,080
6"	87148	185	\$ 1,827
8"	87149	299	\$ 3,240
10"	87150	372	\$ 4,650
12"	87151	539	\$ 6,476

AUTOMATIC CONTROL VALVES

Model C, CF, & CA



Pilot operated control valves designed and built in compliance with ANSI/AWWA C530 standard.

NSF/ANSI 61 approved fusion bonded epoxy coated ductile iron globe or angle style bodies in full or reduced port configuration*. Valves are fitted with various pilot control systems to control conditions in pressurized pipeline systems.

Available sizes from 3/8" through 36" in three different configurations. Flomatic Automatic Control Valves are AIS Compliant**, Made in the USA, and are covered with a three year warranty .



* Please consult factory for configuration and sizes.
 **Must specify AIS requirements at time of quote and order.



Automatic Control Valves by Flomatic Valves



MODEL C
FULL PORT GLOBE STYLE
 (Flanged or Threaded)



MODEL CF
REDUCED PORT GLOBE STYLE
 (Flanged)



MODEL CA
ANGLE BODY STYLE
 (Flanged or Threaded)

Let us help you get the project right from start.
 Call our customer service representatives today at 800.833.2040 to assist you in selecting the control valve that is best for your application.

SEVERAL SERIES AVAILABLE

- ▶ Pressure Reducing Valve
- ▶ Modulating Altitude Valve
- ▶ Non-Modulating Altitude Valve
- ▶ Back Pressure Sustaining Valve
- ▶ Pressure Relief Valve
- ▶ Surge Arrestor Valve
- ▶ Pump Control Valve
- ▶ Pilot Operated Float Valve
- ▶ Solenoid Control Valve
- ▶ Flow Control
- ▶ Hydraulic Check Valve
- ▶ And more...

STANDARD FEATURES...

- ▶ Complies with AWWA C530
- ▶ Fusion bonded epoxy coated Ductile Iron Body. Inside and Outside. Flo-Coat®
- ▶ Copper tubing (SS optional)
- ▶ Control tubing isolation valves
- ▶ Gauge cocks and air bleeder valve
- ▶ Valve Trim - Stainless Steel Standard - Optional Unleaded Bronze
- ▶ Body drain plugs
- ▶ EZ off Jack screw covers & seat rings
- ▶ Unleaded Pilots
- ▶ Air Bleed Standard

POPULAR OPTIONS...

- ▶ Dual power chamber
- ▶ Built-In check feature
- ▶ Stainless Steel Pilots
- ▶ Electronic controls
- ▶ Position indicator (standard 6" and up)



C101 THREADED/CF101/C101/CA101

Discount Code **B**



PRESSURE REDUCING VALVE WITH CHECK - Reduces high upstream pressure to lower downstream pressure. Part numbers below are for standard C101 valve set at 25 - 125 PSI. Consult factory for other options.

SIZE	C/CA THREADED	LIST PRICE	CF FLANGED* 150#	LIST PRICE	SIZE	C/CA C FLANGED 150#	LIST PRICE	C/CA C FLANGED 300#	LIST PRICE
1 1/4"	C101B0B00130	\$1,799			1 1/4"	C101B1B00130	\$ 1,922	C101C2B00130	\$ 2,233
1 1/2"	C101C0B00130	\$1,832			1 1/2"	C101C1B00130	\$ 1,959	C101C2B00130	\$ 2,279
2"	C101D0B00130	\$1,844			2"	C101D1B00130	\$ 2,324	C101D2B00130	\$ 2,454
2 1/2"	C101E0B00130	\$2,298			2 1/2"	C101E1B00130	\$ 2,439	C101E2B00130	\$ 2,792
3"	C101F0B00130	\$2,461			3"	C101F1B00130	\$ 2,495	C101F2B00130	\$ 2,848
4"			CF101G1B00130	\$2,553	4"	C101G1B00130	\$ 3,208	C101G2B00130	\$ 3,497
6"			CF101J1B00130	\$3,872	6"	C101J1B00130	\$ 5,066	C101J2B00130	\$ 5,533
8"			CF101K1B00130	\$6,274	8"	C101K1B00130	\$ 8,495	C101K2B00130	\$ 9,350
10"			CF101L1B00130	\$9,197	10"	C101L1B00130	\$ 11,947	C101L2B00130	\$ 13,072
12"			CF101M1B00130	\$14,854	12"	C101M1B00130	\$ 18,550	C101M2B00130	\$ 19,944
14"			CF101N1B00130	POA	14"	C101N1B00130	POA	C101N2B00130	POA
16"			CF101O1B00130	POA	16"	C101O1B00130	POA	C101O2B00130	POA
18"			CF101P1B00130	POA	18"	C101P1B00130	POA	C101P2B00130	POA
20"			CF101Q1B00130	POA	20"	C101Q1B00130	POA	C101Q2B00130	POA

C103/CA103

Discount Code **B**



PRESSURE REDUCING VALVE WITH CHECK - Reduces high upstream pressure to lower downstream pressure. Check feature prevents reverse flow in the event of pressure reversal.

SIZE	THREADED	CF FLANGED* 150#	C/CA C FLANGED 150#	C/CA C FLANGED 300#
1 1/4"	\$2,178		\$2,299	\$2,587
1 1/2"	\$2,209		\$2,339	\$2,640
2"	\$2,222		\$2,708	\$2,815
2 1/2"	\$2,680		\$2,823	\$3,153
3"	\$2,846		\$2,880	\$3,209
4"		\$2,805	\$3,599	\$3,858
6"		\$4,072	\$5,475	\$5,894
8"		\$6,574	\$9,134	\$9,907
10"		\$9,384	\$12,146	\$13,240
12"		\$14,824	\$18,893	\$20,085
14"		POA	POA	POA
16"		POA	POA	POA
18"		POA	POA	POA
20"		POA	POA	POA

Let us help you get the project right from start.
Call our customer service representatives today at 800.833.2040 to assist you in selecting the control valve that is best for your application.

LARGER SIZES IN STOCK - 16", 20", 24", 30", 36"

C201/CA201

Discount Code **B**



MODULATING ALTITUDE VALVE - Single acting level control with modulation for final filling of storage tanks.

SIZE	THREADED	CF FLANGED* 150#	C/CA C FLANGED 150#	C/CA C FLANGED 300#
1 1/4"	\$4,490		\$4,765	\$5,067
1 1/2"	\$4,583		\$5,170	\$5,531
2"	\$5,049		\$5,723	\$6,057
2 1/2"	\$5,468		\$5,793	\$6,124
3"	\$5,930		\$6,780	\$7,252
4"		\$7,184	\$8,390	\$8,978
6"		\$9,187	\$11,486	\$12,293
8"		\$12,412	\$12,673	\$13,559
10"		\$16,184	\$19,267	\$20,615
12"		\$18,835	\$19,426	\$20,642
14"		POA	POA	POA
16"		POA	POA	POA
18"		POA	POA	POA
20"		POA	POA	POA

C205/CA205

Discount Code **B**



NON-MODULATING ALTITUDE VALVE - Single acting level control of storage tanks, reservoirs, and basins.

SIZE	THREADED	CF FLANGED* 150#	C/CA C FLANGED 150#	C/CA C FLANGED 300#
1 1/4"	\$4,597		\$4,930	\$5,125
1 1/2"	\$4,690		\$5,030	\$5,229
2"	\$5,171		\$5,294	\$5,506
2 1/2"	\$5,600		\$5,862	\$6,094
3"	\$6,073		\$5,935	\$6,169
4"		\$6,540	\$6,941	\$7,212
6"		\$7,357	\$8,593	\$8,931
8"		\$9,408	\$12,353	\$12,839
10"		\$12,712	\$12,979	\$13,492
12"		\$19,287	\$19,955	\$20,515
14"		POA	POA	POA
16"		POA	POA	POA
18"		POA	POA	POA
20"		POA	POA	POA

C301/CA301

Discount Code **B**



BACK PRESSURE SUSTAINING VALVE - Sustains a minimum upstream pressure to prevent over-drafting the supply.

SIZE	THREADED	CF FLANGED* 150#	C/CA C FLANGED 150#	C/CA C FLANGED 300#
1 1/4"	\$1,904		\$2,209	\$2,278
1 1/2"	\$1,915		\$2,254	\$2,324
2"	\$1,960		\$2,295	\$2,402
2 1/2"	\$2,437		\$2,607	\$2,782
3"	\$2,518		\$2,815	\$2,945
4"		\$3,011	\$3,802	\$4,054
6"		\$4,190	\$5,592	\$6,007
8"		\$6,584	\$9,147	\$9,913
10"		\$9,686	\$12,379	\$13,476
12"		\$16,165	\$18,669	\$19,429
14"		POA	POA	POA
16"		POA	POA	POA
18"		POA	POA	POA
20"		POA	POA	POA



AIS Compliant - Made in the USA

Flomatic® offers domestically manufactured valve products that meet the requirements under EPA State Revolving Fund (SRF) for projects in compliance with the American Iron and Steel Act (AIS). Must be specified at time of quote and order.

* Reduced port configuration.

C401/CA401 Discount Code **B**



PRESSURE RELIEF VALVE - Protects against excessive pressure.

SIZE	THREADED	CF FLANGED* 150#	C/CA C C FLANGED 150#	C/CA C FLANGED 300#
1 1/4"		\$1,885	\$2,188	\$2,256
1 1/2"		\$1,898	\$2,232	\$2,302
2"		\$1,942	\$2,273	\$2,379
2 1/2"		\$2,413	\$2,582	\$2,756
3"		\$2,494	\$2,789	\$2,917
4"		\$2,982	\$3,765	\$4,015
6"		\$4,149	\$5,539	\$5,950
8"		\$6,521	\$9,060	\$9,819
10"		\$9,593	\$12,379	\$12,977
12"		\$16,012	\$18,491	\$19,245
14"		POA	POA	POA
16"		POA	POA	POA
18"		POA	POA	POA
20"		POA	POA	POA

C501/CA501 Discount Code **B**



SURGE ARRESTOR VALVE - Provides relief protection against pressure surges during pump start up, shut down, or power failure.

SIZE	THREADED	CF FLANGED* 150#	C/CA C FLANGED 150#	C/CA C FLANGED 300#
1 1/4"		\$4,632	\$5,500	\$5,811
1 1/2"		\$4,727	\$5,612	\$5,930
2"		\$5,380	\$5,907	\$6,241
2 1/2"		\$5,891	\$6,265	\$6,590
3"		\$5,953	\$6,284	\$6,613
4"		\$6,466	\$6,696	\$6,936
6"		\$7,366	\$8,258	\$8,647
8"		\$9,517	\$11,537	\$12,258
10"		\$12,683	\$15,399	\$15,830
12"		\$19,735	\$21,804	\$22,558
14"		POA	POA	POA
16"		POA	POA	POA
18"		POA	POA	POA
20"		POA	POA	POA

10 Reasons to Select Flomatic Automatic Control Valves

Complies with ANSI/AWWA C530

- 1 NSF/ANSI 61*
- 2 Isolation Valves Standard
- 3 Drain Plug Standard
- 4 Test Cocks Standard
- 5 All SS-Fasteners Standard
- 6 Jack Screws Standard
- 7 Indicator Rod Standard 6" and up
- 8 Air Bleed Valve Standard
- 9 Low Head loss
- 10 100% Hydro Tested

*1 1/4" - 12" Consult factory for configuration

Let us help you get the project right from start. Call our customer service representatives today at 800.833.2040 to assist you in selecting the control valve that is best for your application.

C611/CA611 Discount Code **B**



BOOSTER PUMP CONTROL VALVE - Eliminates pump station pressure surges during start up and shut down. Equipped with internal drop check feature.

SIZE	CF FLANGED* 150#	C/CA C FLANGED 150#	C/CA C FLANGED 300#
3"		\$7,903	\$8,459
4"		\$8,326	\$9,396
6"		\$9,870	\$11,337
8"		\$12,255	\$15,395
10"		\$18,704	\$24,010
12"		\$26,345	\$29,165
14"		POA	POA
16"		POA	POA
18"		POA	POA
20"		POA	POA

C621/CA621 Discount Code **B**



DEEP WELL PUMP CONTROL VALVE - Eliminates pump station pressure surges during start up and shut down.

SIZE	CF FLANGED* 150#	C/CA C FLANGED 150#	C/CA C FLANGED 300#
3"		\$7,086	\$7,665
4"		\$7,505	\$8,632
6"		\$9,034	\$10,506
8"		\$11,140	\$14,433
10"		\$17,838	\$23,390
12"		\$25,809	\$30,169
14"		POA	POA
16"		POA	POA
18"		POA	POA
20"		POA	POA

C701/CA701 Discount Code **B**



PILOT OPERATED FLOAT VALVE - For level control of storage tanks, reservoirs, or basins.

SIZE	THREADED	CF FLANGED* 150#	C/CA C FLANGED 150#	C/CA C FLANGED 300#
1 1/4"		\$2,213	\$2,340	\$2,614
1 1/2"		\$2,213	\$2,387	\$2,666
2"		\$2,252	\$2,729	\$2,830
2 1/2"		\$2,690	\$2,836	\$3,029
3"		\$2,737	\$2,889	\$3,135
4"		\$2,952	\$3,744	\$3,984
6"		\$4,193	\$5,291	\$5,677
8"		\$6,434	\$8,493	\$9,210
10"		\$9,161	\$11,300	\$12,294
12"		\$15,279	\$18,242	\$18,988
14"		POA	POA	POA
16"		POA	POA	POA
18"		POA	POA	POA
20"		POA	POA	POA



AIS Compliant - Made in the USA

Flomatic® offers domestically manufactured valve products that meet the requirements under EPA State Revolving Fund (SRF) for projects in compliance with the American Iron and Steel Act (AIS). Must be specified at time of quote and order.

* Reduced port configuration.

C705/CA705 Discount Code **B**



NON-MODULATING PILOT OPERATED FLOAT VALVE - For level control of storage tanks, reservoirs, or basins.

SIZE	THREADED	CF FLANGED* 150#	C/CA C FLANGED 150#	C/CA C FLANGED 300#
1 1/4"		\$2,791	\$3,080	\$3,358
1 1/2"		\$2,848	\$3,143	\$3,427
2"		\$2,972	\$3,493	\$3,593
2 1/2"		\$3,000	\$3,601	\$3,797
3"		\$3,312	\$3,654	\$3,905
4"		\$3,992	\$4,497	\$4,761
6"		\$4,998	\$6,104	\$6,497
8"		\$7,281	\$9,368	\$10,098
10"		\$10,061	\$12,196	\$13,207
12"		\$16,299	\$19,272	\$20,033
14"		POA	POA	POA
16"		POA	POA	POA
18"		POA	POA	POA
20"		POA	POA	POA

C801/CA801 Discount Code **B**



SOLENOID CONTROL VALVE - Remote actuation for valve position. 801 Energize to open valve, 802 Energize to close valve.

SIZE	THREADED	CF FLANGED* 150#	C/CA C FLANGED 150#	C/CA C FLANGED 300#
1 1/4"		\$2,224	\$2,351	\$2,626
1 1/2"		\$2,224	\$2,399	\$2,680
2"		\$2,263	\$2,742	\$2,844
2 1/2"		\$2,703	\$2,850	\$3,044
3"		\$2,727	\$2,903	\$3,150
4"		\$2,967	\$3,763	\$4,003
6"		\$4,214	\$5,316	\$5,705
8"		\$6,466	\$8,535	\$9,254
10"		\$9,206	\$11,849	\$12,353
12"		\$15,353	\$18,330	\$19,081
14"		POA	POA	POA
16"		POA	POA	POA
18"		POA	POA	POA
20"		POA	POA	POA

C901/CA901 Discount Code **B**



FLOW CONTROL VALVE - Maintains a pre-set maximum flow rate regardless of changing line pressures.

SIZE	CF FLANGED* 150#	C/CA C FLANGED 150#	C/CA C FLANGED 300#
2"		\$2,910	\$2,985
2 1/2"		\$4,203	\$4,485
3"		\$4,343	\$4,507
4"	\$3,836	\$5,185	\$5,430
6"	\$5,654	\$6,930	\$7,325
8"	\$8,147	\$10,456	\$11,185
10"	\$10,612	\$14,119	\$14,741
12"	\$16,860	\$20,181	\$20,942
14"	POA	POA	POA
16"	POA	POA	POA
18"	POA	POA	POA
20"	POA	POA	POA

C1001/CA1001 Discount Code **B**



HYDRAULIC CHECK VALVE - Closes to prevent flow reversal. Adjustable opening & closing speed controls.

SIZE	THREADED	CF FLANGED* 150#	C/CA C FLANGED 150#	C/CA C FLANGED 300#
1 1/4"		\$1,576	\$1,667	\$1,940
1 1/2"		\$1,609	\$1,701	\$1,980
2"		\$1,706	\$2,044	\$2,144
2 1/2"		\$2,068	\$2,210	\$2,510
3"		\$2,193	\$2,329	\$2,628
4"		\$2,410	\$3,035	\$3,274
6"		\$3,744	\$4,618	\$5,005
8"		\$6,155	\$8,285	\$9,006
10"		\$9,086	\$11,102	\$11,686
12"		\$15,665	\$17,870	\$18,620
14"		POA	POA	POA
16"		POA	POA	POA
18"		POA	POA	POA
20"		POA	POA	POA

C000 MINI Discount Code **B**



HYDRAULIC CONTROL VALVE - Water or Air operated.

Temp Max: 180°F (80°C) Pressure Max: 400 PSI

SIZE	MODEL NO.	WGT	LIST PRICE
3/8"	C000AAA	2	\$ 237
1/2"	C000AA	2	\$ 267
3/4"	C000AA	3	\$ 285
1"	C000A	5	\$ 292
1 1/4"	C000B	5	\$ 315

316 BALL VALVE Discount Code **B**



316SS BALL VALVE - Full Port, FNPT connection, drilled and tapped for 2 bolt mounting pad, SS locking handle.

Temp Max: 400° F (204° C) Pressure Max: 1000 PSI

SIZE	PART NUMBER	LIST PRICE
1/4"	SSBV1000-02	\$ 45
3/8"	SSBV1000-03	\$ 45
1/2"	SSBV1000-05	\$ 48
3/4"	SSBV1000-07	\$ 64
1"	SSBV1000-10	\$ 108
1 1/4"	SSBV1000-12	\$ 162
1 1/2"	SSBV1000-15	\$ 213
2"	SSBV1000-20	\$ 271
2 1/2"	SSBV1000-25	\$ 586
3"	SSBV1000-30	\$ 966

PRESSURE GAUGES Discount Code **B**



PRESSURE GAUGES - 2.5 inch dial, 1/4" NPT bottom connection, unleaded. 1.5% accuracy Full Scale. 304SS case liquid glycerin filled bronze tube & connection.

RANGE	PART NUMBER	LIST PRICE
0-100 PSI	2-PG25-100G	\$ 25
0-200 PSI	2-PG25-200G	\$ 25
0-300 PSI	2-PG25-300G	\$ 25
0-400 PSI	2-PG25-400G	\$ 25

* Reduced port configuration.

PRP Discount Code **B**



PRP - 3/8" Pressure Reducing Pilot in Unleaded Bronze or 316 Stainless Steel* - Pilot control valve that automatically reduces a higher inlet pressure to a lower outlet pressure. It is a direct acting, spring-loaded, diaphragm valve that operates hydraulically and is designed to maintain a pre-set outlet pressure. Senses downstream pressure directly.

Temp Max: 180°F (80°C) Pressure Max: 400 PSI

PART NO.	SPRING RANGE	LIST	LIST
		PRICE	PRICE
152100A	5 - 80 PSI	\$ 364	\$ 564
152100B	25 - 125 PSI	\$ 364	\$ 564
152100C	2 - 35 PSI	\$ 364	\$ 564
152100D	30 - 300 PSI	\$ 364	\$ 564

* For stainless steel, put "S" before letter & after part number.

BPP Discount Code **B**



BPP - 3/8" Back Pressure Sustaining Pilot
Pilot control valve that automatically maintains a minimum inlet pressure. It is a direct acting, spring-loaded, diaphragm valve that operates hydraulically and is designed to maintain a pre-set inlet pressure. Can also be used as a pressure relief valve/pilot control.

Temp Max: 180°F (80°C) Pressure Max: 400 PSI

PART NO.	SPRING RANGE	LIST PRICE
160100SA	5 - 80 PSI	\$ 651
160100SB	25 - 125 PSI	\$ 651
160100SC	2 - 35 PSI	\$ 651
160100SD	30 - 300 PSI	\$ 651

PRR Discount Code **B**



PRR - 3/8" Pressure Reducing Pilot (Remote)
All 316 Stainless Steel pilot control valve that automatically reduces a higher inlet pressure to a lower outlet pressure. It is a direct acting, spring-loaded, diaphragm valve that operates hydraulically and is designed to maintain a pre-set outlet pressure. Senses downstream pressure remotely.

Temp Max: 180°F (80°C) Pressure Max: 400 PSI

PART NO.	SPRING RANGE	LIST PRICE
152100SA	5 - 80 PSI	\$ 651
152100SB	25 - 125 PSI	\$ 651
152100SC	2 - 35 PSI	\$ 651
152100SD	30 - 300 PSI	\$ 651

TEST COCKS Discount Code **B**



TEST COCKS - Unleaded Bronze test cocks, full port standard.

SIZE	PART NO.	CASE QTY.	LIST PRICE
1/4" x 1/4"	9383397E	4	\$ 13
3/8" x 1/4"	9383395E	4	\$ 13

Y STRAINER Discount Code **B**



Y STRAINER - Unleaded Bronze body, 20 mesh stainless steel strainer. Furnished with clean out plug.

SIZE	PART NO.	LIST PRICE
3/8" Inlet x 1/4" Outlet	8710E	\$ 33

See page 20 for other sizes.

MINI BALL VALVE Discount Code **B**



MINI BALL VALVE - Mini ball valves are a quarter turn full ported on off isolation valves used on external control valve pilot controls.

SIZE	PART NO.	LIST PRICE
3/8"	149B5369	\$ 15

ACP MODEL 165 Discount Code **B**



ACP - Accelerator Pilot in Unleaded Bronze
It is used in systems to control flow by applying an independent pressure to the diaphragm. Enables automatic control valves to rapidly vent water from control diaphragm, thus allowing quicker main valve opening.

Temp Max: 180°F (80°C) Pressure Max: 300 PSI

SIZE	PART NO.	LIST PRICE
1/2"	165200	\$ 1,002

CV80S6 Discount Code **B**



CV80S6 CHECK VALVE - All 316SS body with Delrin poppet and Buna-N seal. Threaded female x female connection.

Temp Max: 180°F (80°C) Pressure Max: 400 PSI

SIZE	PART NO.	WGT.	LIST PRICE
1/4"	5158	.43	\$ 136
3/8"	5159	.45	\$ 149
1/2"	4029	.59	\$ 198

FC4 Discount Code **B**



FLOW CONTROL - 3/8" Adjustable restrictor for use as an opening or closing speed controller.

SIZE	PART NO.	LIST PRICE
3/8"	FC4	\$ 336

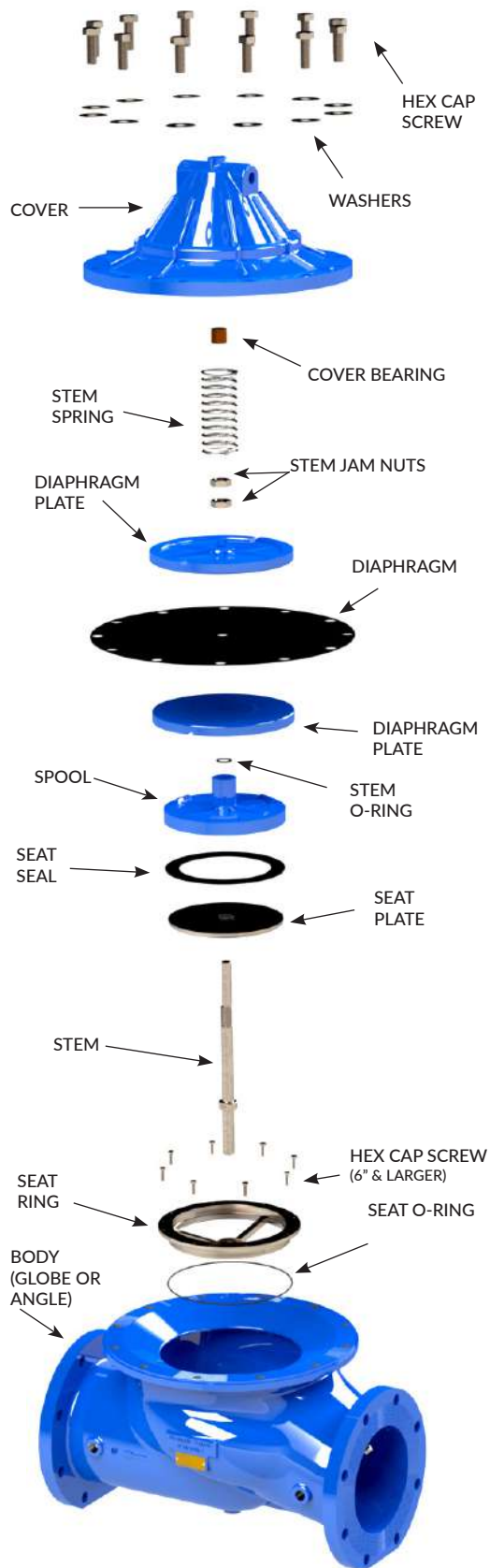

C = FULL PORT CF = REDUCED PORT

BODY SOFT SEAL BUNA/VITON KITS
 (Includes: "O" - Rings, Diaphragm, and Seat Seal)
 Consult Factory for Larger 12" size thru 36" sizes

Discount Code **B**

PART NO.	DESCRIPTION	LIST PRICE
CRK201	CV repair kit, BUNA, C 1 1/2"	\$ 58
CRK202	CV repair kit, BUNA, C 2", CF 3"	\$ 62
CRK203	CV repair kit, BUNA, C 2 1/2" & 3", CF 4"	\$ 82
CRK204	CV repair kit, BUNA, C 4", CF 6"	\$ 120
CRK206	CV repair kit, BUNA, C 6", CF 8"	\$ 161
CRK208	CV repair kit, BUNA, C 8", CF 10"	\$ 238
CRK210	CV repair kit, BUNA, C 10", CF 12"	\$ 460
CRK212	CV repair kit, BUNA, C 12", CF 14"	\$ 630
CRV015	CV repair kit, Viton, C 1 1/2"	\$ 107
CRV003	CV repair kit, Viton, C 3", CF 4"	\$ 200
CRV004	CV repair kit, Viton, C 4", CF 6"	\$ 366
CRV006	CV repair kit, Viton, C 6", CF 8"	\$ 609

PILOT REPAIR KITS

Discount Code **B**

PART NO.	DESCRIPTION	LIST PRICE
CRKALT	Altitude pilot repair kit, BUNA (must specify spring range)	\$ 601
152100KIT	PRP repair kit, BUNA, bronze	\$ 38
152100VKIT	PRP repair kit, Viton, bronze	\$ 108
152100SKIT	PRP repair kit, BUNA, SS	\$ 40
152100SVKIT	PRP repair kit, Viton, SS	\$ 109
160100KIT	BPP repair kit, BUNA, Bronze or SS	\$ 134
160100VKIT	BPP repair kit, Viton, Bronze or SS	\$ 148

FACTORY ASSEMBLED SPOOL ASSEMBLIES
 (Includes: Stem, seat plate, seat seal, stem "O"-Ring, Spool, Upper & Lower Diaphragm plate, Diaphragm and Stem Jam Nuts)

Discount Code **B**

PART #	DESCRIPTION	LIST PRICE
SPOOLKIT03	Spool replacement kit C 1 1/4" & 1 1/2"	\$ 325
SPOOLKIT04	Spool replacement kit C 2", CF 3"	\$ 261
SPOOLKIT06	Spool replacement kit C 2 1/2", CF 3" & 4"	\$ 443
SPOOLKIT07	Spool replacement kit C 4", CF 6"	\$ 626
SPOOLKIT09	Spool replacement kit C 6", CF 8"	\$ 1,206
SPOOLKIT10	Spool replacement kit C 8", CF 10"	\$ 1,900
SPOOLKIT11	Spool replacement kit C 10", CF 12"	\$ 3,266
SPOOLKIT12	Spool replacement kit C 12"	\$ 4,793

NOTE: PLEASE SPECIFY CONTROL VALVE S/N WHEN ORDERING REPAIR KITS

Call our customer service representatives at 800.833.2040 to request our Control Valve Price List and Literature.

FLO-TROL® Flow Control Valves

MODEL CD900

Constant Flow Control Valve

- Constant Flow Rates
- Booster Pump Systems
- Domestic Water Systems
- Sizes 3/8" thru 2" (.25 - 30 GPM*)
- NSF/ANSI 61 and 372 Certified
- Stainless Steel Construction
- Laser engraved flow rate and size



Flo-Trol® automatic flow control valves are designed to give constant flow over a wide pressure range. The internal controlling mechanism has no moving part, consisting only of a flexible orifice that varies with applied pressure maintaining a constant flow rate.

Flow rates are maintained to within ±15% between 15 and 125 PSI (1 to 8.6 bar). The flow rate varies due to manufacturing tolerances and water temperatures. Valve bodies are stainless steel (not chrome or nickel-plated brass) with a Buna-N orifice (NSF/ANSI 61 certified).

Temp Max: 180 °F Pressure Max: 200 PSI Discount Code **A**

Flo-matic Part Number	Similar to Dole® Cross Reference	Flo-Trol® Model Description	FLOMATIC List Price
3/8" Model CDA			
CDA.25	GA.25	3/8"F X 3/8"F 0.25 GPM	\$ 25.85
CDA.50	GA.50	3/8"F X 3/8"F 0.5 GPM	\$ 25.85
CDA.75	GA.75	3/8"F X 3/8"F 0.75 GPM	\$ 25.85
CDA1.0	GA1.0	3/8"F X 3/8"F 1 GPM	\$ 25.85
1/2" Model CDB			
CDB1.0	GB1.0	1/2"F X 1/2"F 1 GPM	\$ 32.00
CDB1.5	GB1.5	1/2"F X 1/2"F 1.5 GPM	\$ 32.00
CDB2.0	GB2.0	1/2"F X 1/2"F 2 GPM	\$ 32.00
CDB2.5	GB2.5	1/2"F X 1/2"F 2.5 GPM	\$ 32.00
CDB3.0	GB3.0	1/2"F X 1/2"F 3 GPM	\$ 32.00
CDB3.5	GB3.5	1/2"F X 1/2"F 3.5 GPM	\$ 32.00
CDB4.0	GB4.0	1/2"F X 1/2"F 4 GPM	\$ 32.00
CDB4.5	GB4.5	1/2"F X 1/2"F 4.5 GPM	\$ 32.00
CDB5.0	GB5.0	1/2"F X 1/2"F 5 GPM	\$ 32.00
CDB6.0	GB6.0	1/2"F X 1/2"F 6 GPM	\$ 32.00
3/4" Model CDC			
CDC1.0	GC1.0	3/4"F X 3/4"F 1 GPM	\$ 63.00
CDC1.5	GC1.5	3/4"F X 3/4"F 1.5 GPM	\$ 63.00
CDC2.0	GC2.0	3/4"F X 3/4"F 2 GPM	\$ 63.00
CDC2.5	GC2.5	3/4"F X 3/4"F 2.5 GPM	\$ 63.00
CDC3.0	GC3.0	3/4"F X 3/4"F 3 GPM	\$ 63.00
CDC3.5	GC3.5	3/4"F X 3/4"F 3.5 GPM	\$ 63.00
CDC4.0	GC4.0	3/4"F X 3/4"F 4 GPM	\$ 63.00
CDC4.5	GC4.5	3/4"F X 3/4"F 4.5 GPM	\$ 63.00
CDC5.0	GC5.0	3/4"F X 3/4"F 5 GPM	\$ 63.00
CDC6.0	GC6.0	3/4"F X 3/4"F 6 GPM	\$ 63.00
CDC7.0	GC7.0	3/4"F X 3/4"F 7 GPM	\$ 63.00
CDC8.0	GC8.0	3/4"F X 3/4"F 8 GPM	\$ 63.00
CDC9.0	GC9.0	3/4"F X 3/4"F 9 GPM	\$ 63.00
CDC10	GC10	3/4"F X 3/4"F 10 GPM	\$ 63.00
CDC11.5	GC11.5	3/4"F X 3/4"F 11.5 GPM	\$ 63.00
3/4" Model CDY			
CDY1.0	GY1.0	3/4"M X 3/4"F 1 GPM	\$ 63.00
CDY1.5	GY1.5	3/4"M X 3/4"F 1.5 GPM	\$ 63.00
CDY2.0	GY2.0	3/4"M X 3/4"F 2 GPM	\$ 63.00
CDY2.5	GY2.5	3/4"M X 3/4"F 2.5 GPM	\$ 63.00
CDY3.0	GY3.0	3/4"M X 3/4"F 3 GPM	\$ 63.00
CDY3.5	GY3.5	3/4"M X 3/4"F 3.5 GPM	\$ 63.00
CDY4.0	GY4.0	3/4"M X 3/4"F 4 GPM	\$ 63.00
CDY4.5	GY4.5	3/4"M X 3/4"F 4.5 GPM	\$ 63.00
CDY5.0	GY5.0	3/4"M X 3/4"F 5 GPM	\$ 63.00
CDY6.0	GY6.0	3/4"M X 3/4"F 6 GPM	\$ 63.00
CDY7.0	GY7.0	3/4"M X 3/4"F 7 GPM	\$ 63.00
CDY8.0	GY8.0	3/4"M X 3/4"F 8 GPM	\$ 63.00
CDY9.0	GY9.0	3/4"M X 3/4"F 9 GPM	\$ 63.00
CDY10	GY10	3/4"M X 3/4"F 10 GPM	\$ 63.00
CDY11.5	GY11.5	3/4"M X 3/4"F 11.5 GPM	\$ 63.00

Temp Max: 180 °F Pressure Max: 200 PSI Discount Code **A**

Flo-matic Part Number	Similar to Dole® Cross Reference	Flo-Trol® Model Description	FLOMATIC List Price
1" Model CDX			
CDX1.0	GX1.0	1"F X 1"F 1 GPM	\$ 80.00
CDX1.5	GX1.5	1"F X 1"F 1.5 GPM	\$ 80.00
CDX2.0	GX2.0	1"F X 1"F 2 GPM	\$ 80.00
CDX2.5	GX2.5	1"F X 1"F 2.5 GPM	\$ 80.00
CDX3.0	GX3.0	1"F X 1"F 3 GPM	\$ 80.00
CDX3.5	GX3.5	1"F X 1"F 3.5 GPM	\$ 80.00
CDX4.0	GX4.0	1"F X 1"F 4 GPM	\$ 80.00
CDX4.5	GX4.5	1"F X 1"F 4.5 GPM	\$ 80.00
CDX5.0	GX5.0	1"F X 1"F 5 GPM	\$ 80.00
CDX6.0	GX6.0	1"F X 1"F 6 GPM	\$ 80.00
CDX7.0	GX7.0	1"F X 1"F 7 GPM	\$ 80.00
CDX8.0	GX8.0	1"F X 1"F 8 GPM	\$ 80.00
CDX9.0	GX9.0	1"F X 1"F 9 GPM	\$ 80.00
CDX10	GX10	1"F X 1"F 10 GPM	\$ 80.00
CDX12	GX12	1"F X 1"F 12 GPM	\$ 80.00
CDX15	GX15	1"F X 1"F 15 GPM	\$ 80.00
CDX17	GX17	1"F X 1"F 17 GPM	\$ 80.00
CDX20	GX20	1"F X 1"F 20 GPM	\$ 80.00
CDX25	GX25	1"F X 1"F 25 GPM	\$ 80.00
CDX30	GX30	1"F X 1"F 30 GPM	\$ 80.00
1 1/4" Model CDP			
CDP1.0	GP1.0	1 1/4"M X 1 1/4"M 1 GPM	\$ 116.00
CDP1.5	GP1.5	1 1/4"M X 1 1/4"M 1.5 GPM	\$ 116.00
CDP2.0	GP2.0	1 1/4"M X 1 1/4"M 2 GPM	\$ 116.00
CDP2.5	GP2.5	1 1/4"M X 1 1/4"M 2.5 GPM	\$ 116.00
CDP3.0	GP3.0	1 1/4"M X 1 1/4"M 3 GPM	\$ 116.00
CDP3.5	GP3.5	1 1/4"M X 1 1/4"M 3.5 GPM	\$ 116.00
CDP4.0	GP4.0	1 1/4"M X 1 1/4"M 4 GPM	\$ 116.00
CDP4.5	GP4.5	1 1/4"M X 1 1/4"M 4.5 GPM	\$ 116.00
CDP5.0	GP5.0	1 1/4"M X 1 1/4"M 5 GPM	\$ 116.00
CDP6.0	GP6.0	1 1/4"M X 1 1/4"M 6 GPM	\$ 116.00
CDP7.0	GP7.0	1 1/4"M X 1 1/4"M 7.0 GPM	\$ 116.00
CDP8.0	GP8.0	1 1/4"M X 1 1/4"M 8 GPM	\$ 116.00
CDP9.0	GP9.0	1 1/4"M X 1 1/4"M 9 GPM	\$ 116.00
CDP10	GP10	1 1/4"M X 1 1/4"M 10 GPM	\$ 116.00
CDP12	GP12	1 1/4"M X 1 1/4"M 12 GPM	\$ 116.00
CDP15	GP15	1 1/4"M X 1 1/4"M 15 GPM	\$ 116.00
CDP17	GP17	1 1/4"M X 1 1/4"M 17 GPM	\$ 116.00
CDP20	GP20	1 1/4"M X 1 1/4"M 20 GPM	\$ 116.00
CDP25	GP25	1 1/4"M X 1 1/4"M 25 GPM	\$ 116.00
CDP30	GP30	1 1/4"M X 1 1/4"M 30 GPM	\$ 116.00
1 1/2" Model CDT			
CDT9.0	GT9.0	1 1/2"M X 1 1/2"M 9.0 GPM	\$ 142.00
CDT10	GT10	1 1/2"M X 1 1/2"M 10 GPM	\$ 142.00
CDT12	GT12	1 1/2"M X 1 1/2"M 12 GPM	\$ 142.00
CDT15	GT15	1 1/2"M X 1 1/2"M 15 GPM	\$ 142.00
CDT17	GT17	1 1/2"M X 1 1/2"M 17 GPM	\$ 142.00
CDT20	GT20	1 1/2"M X 1 1/2"M 20 GPM	\$ 142.00
CDT25	GT25	1 1/2"M X 1 1/2"M 25 GPM	\$ 142.00
CDT30	GT30	1 1/2"M X 1 1/2"M 30 GPM	\$ 142.00
NEW SIZES 2" Model CDF			
CDF9.0	GF9.0	2"M X 2"M 9.0 GPM	\$ 242.00
CDF10	GF10	2"M X 2"M 10 GPM	\$ 242.00
CDF12	GF12	2"M X 2"M 12 GPM	\$ 242.00
CDF15	GF15	2"M X 2"M 15 GPM	\$ 242.00
CDF17	GF17	2"M X 2"M 17 GPM	\$ 242.00
CDF20	GF20	2"M X 2"M 20 GPM	\$ 242.00
CDF25	GF25	2"M X 2"M 25 GPM	\$ 242.00
CDF30	GF30	2"M X 2"M 30 GPM	\$ 242.00

NOTE: "Dole®" is a registered trademark of Siebe, Inc. of Foxboro, Massachusetts

* Consult factory for other sizes, flows, and GPM.

C150EHF Discount Code **A**



PRESSURE REDUCING VALVE (PRV) - Model C150EHF when properly installed will regulate high inlet pressure to a lower regulated outlet pressure within a range regardless of water flow. This is accomplished by an adjustable spring loaded balancing valve factory set to automatically regulate the downstream pressure.

High flow to 70 GPM

ASSE® Listed 1003

Temp Max: 180 °F (80 °C) Pressure Max: 400 PSI
Factory set at 50 PSI

Part numbers are for 15 - 75 PSI range

SIZE	PART NO.	WGT.	LIST PRICE
1 1/4"	C150002EHF	5.2	\$ 1,198

Part numbers are for 15 - 150 PSI range

SIZE	PART NO.	WGT.	LIST PRICE
1 1/4"	C150102EHF	5.2	\$ 1,198

See 1 1/2" & 2" sizes model C150E.

C150E Discount Code **A**



PRESSURE REDUCING VALVE (PRV) - Model C150E when properly installed will regulate high inlet pressure to a lower regulated outlet pressure within a range regardless of water flow. This is accomplished by an adjustable spring loaded balancing valve factory set to automatically regulate the downstream pressure. Supplied with one FNPT tail-piece and union nut.

NSF/ANSI 61 Certified and ASSE® Listed 1003

Temp Max: 180 °F (80 °C) Pressure Max: 400 PSI
Factory set at 50 PSI

Part numbers are for 15 - 75 PSI range

SIZE	PART NO.	WGT.	LIST PRICE
1/2"	C150099E	2.2	\$ 207
3/4"	C150000E	2.2	\$ 213
1"	C150001E	3.5	\$ 259
1 1/4"*	C150002E*	5.2	\$ 455
1 1/2"	C150003E	15	\$ 1,360
2"	C150004E	15	\$ 1,455

Part numbers are for 15 - 150 PSI range

SIZE	PART NO.	WGT.	LIST PRICE
1/2"	C150199E	2.2	\$ 207
3/4"	C150100E	2.2	\$ 213
1"	C150101E	3.5	\$ 259
1 1/4"*	C150102E*	5.2	\$ 455
1 1/2"	C150103E	15	\$ 1,360
2"	C150104E	15	\$ 1,455

* Note: 1 1/4" size is one size smaller restricted flow. Maximum 25 GPM, see model C150EHF on left for higher capacity.

For double union add "U" to the end of the part number and add 10% to the list price.

C150ET Discount Code **A**



PRESSURE REDUCING VALVE (PRV) - Model C150E when properly installed will regulate high inlet pressure to a lower regulated outlet pressure within a range regardless of water flow. This is accomplished by an adjustable spring loaded balancing valve factory set to automatically regulate the downstream pressure.

NSF/ANSI 61 Certified and ASSE® Listed 1003

Temp Max: 180 °F (80 °C) Pressure Max: 400 PSI
Factory set at 50 PSI

Part numbers are for 15 - 75 PSI range

SIZE	PART NO.	WGT.	LIST PRICE
3/4"F & 1"M	C150000ET	2.2	\$ 176
1"F & 1 1/4"M*	C150001ET*	3.5	\$ 227

Part numbers are for 15 - 150 PSI range

SIZE	PART NO.	WGT.	LIST PRICE
3/4"F & 1"M	C150100ET	2.2	\$ 176
1"F & 1 1/4"M*	C150101ET*	3.5	\$ 227

* 1" NPT ID & 1 1/4" NPT OD-Dual Purpose Threads.

PRODUCT SPECIFICATIONS

- Max Pressure: 400 PSI (27 bar) • Max Temperature: 180 °F (80 °C)
- Pressure Regulating Setting: Factory set at 50 psi • Standard Spring Adjustment range see part number chart

Model	Description	End-Connections	
		Inlet	Outlet
C150E	Unleaded Valve Body	Female NPT	Single Union End w/Female NPT
C150EU (10% adder)	Unleaded Valve Body	Union End w/Female NPT	
C150ET	Unleaded Valve Body	Female NPT/Male NPT (No union end)	

CONSTANT PRESSURE PUMP CONTROL

⚠ FOR PRESSURE REDUCING VALVES SEE PG. 22 & 28

CYCLE GARD® I C152E Discount Code A



DIRECT ACTING CONSTANT PRESSURE PUMP CONTROL VALVE - Reduces rapid pump cycling and maintains a pre-set operating pressure for pump systems. Threaded female x female connection. Features an unleaded body & composite bell housing, Nylon reinforced Buna-N diaphragm. Supplied with two FNPT tail piece and union nuts.

Temp Max: 180°F (80°C) Pressure Max: 400 PSI
Factory set at 50 PSI

SIZE	PART NO.	SPRING RANGE	LIST PRICE
3/4"	C152000E	15 - 75 PSI	\$ 328
1"	C152001E	15 - 75 PSI	\$ 391
1 1/4"*	C152002E*	15 - 75 PSI	\$ 688
1 1/2"	C152003E	15 - 75 PSI	\$ 1,401
2"	C152004E	15 - 75 PSI	\$ 1,573
3/4"	C152100E	15 - 150 PSI	\$ 328
1"	C152101E	15 - 150 PSI	\$ 391
1 1/4"*	C152102E*	15 - 150 PSI	\$ 688
1 1/2"	C152103E	15 - 150 PSI	\$ 1,401
2"	C152104E	15 - 150 PSI	\$ 1,573

*Note: 1 1/4" size is one size smaller restricted flow, maximum 20 GPM. See model C152EHF below for higher capacity.

CYCLE GARD® HY-FLOW CB152EHF Discount Code A



HIGH FLOW DIRECT ACTING CONSTANT PRESSURE PUMP CONTROL VALVE - Model C152EHF reduces rapid pump cycle with field adjustable by-pass and maintains a pre-set operating downstream pressure for pump systems. Threaded female x female NPT connection with hex end OD. Features an unleaded body and cover. Nylon reinforced Buna-N diaphragm. Ideal for flows up to 70 GPM.

Temp Max: 180°F (80°C) Pressure Max 400 PSI
Factory set at 50 PSI

SIZE	PART NO.	SPRING RANGE	LIST PRICE
1 1/4"	C152002EHF	15 - 75 PSI	\$ 1,305
1 1/2"	C152102EHF	15 - 150 PSI	\$ 1,305

CYCLE GARD® I C152ET Discount Code A



DIRECT ACTING CONSTANT PRESSURE PUMP CONTROL VALVE - Dual purpose threads, reduces rapid pump cycling and maintains a pre-set operating pressure for pump systems. 1" threaded female I.D. x 1 1/4" male O.D. on inlet and outlet connections. Features an unleaded body & composite bell housing, Nylon reinforced Buna-N diaphragm.

Temp Max: 180°F (80°C) Pressure Max: 400 PSI
Factory set at 50 PSI

SIZE	PART NO.	SPRING RANGE	LIST PRICE
1"F & 1 1/4"M	C152001ET	15 - 75 PSI	\$ 362
1"F & 1 1/4"M	C152101ET	15 - 150 PSI	\$ 362

CYCLE GARD® IV CB152ET / CB152E Discount Code A



DIRECT ACTING CONSTANT PRESSURE PUMP CONTROL VALVE WITH TAPPINGS - Reduces rapid pump cycling and maintains a pre-set operating pressure for pump systems. Threaded female x female union ends or female I.D. & male O.D. on inlet and outlet connections. Features a flow efficient globe style unleaded alloy body & composite bell housing, Nylon reinforced Buna-N diaphragm. With two (2) 1/4" tappings for gage and pressure switch. One (1) 3/4" tapping for water tank. Model CB152E supplied with two FNPT tail-piece and union nuts.

Temp Max: 180°F (80°C) Pressure Max 400 PSI
Factory set at 50 PSI

Model CB152ET - Dual Purpose Threads

SIZE	PART NO.	SPRING RANGE	LIST PRICE
1"F & 1 1/4" M	CB152001ET	15 - 75 PSI	\$ 425
1"F & 1 1/4" M	CB152101ET	15 - 150 PSI	\$ 425

Model CB152E

SIZE	PART NO.	SPRING RANGE	LIST PRICE
1"	CB152001E	15 - 75 PSI	\$ 417
1"	CB152101E	15 - 150 PSI	\$ 417

CYCLE GARD® II CN101/CNA101 Discount Code A



CONSTANT PRESSURE PUMP CONTROL - Reduces rapid pump cycle with field adjustable by-pass and maintains a pre-set operating downstream pressure. For use with domestic water well, municipal water systems, industrial water system, irrigation and agriculture.

For angle body add "A" after "N" in the part number

Temp Max: 180°F (80°C) Pressure Max: 400 PSI
Factory set at 60 PSI

SIZE	PART NO. THREADED	LIST PRICE	PART NO. FLANGED 150#	LIST PRICE
1 1/4"	CN1010B	\$ 3,178		
1 1/2"	CN1010C	\$ 3,234	CN1011C	\$ 3,461
2"	CN1010D	\$ 3,259	CN1011D	\$ 4,107
2 1/2"	CN1010E	\$ 4,058	CN1011E	\$ 4,309
3"	CN1010F	\$ 4,349	CN1011F	\$ 4,408
4"			CN1011G	\$ 5,667
6"			CN1011J	\$ 8,950
8"			CN1011K	\$ 15,008

CYCLE GARD® IV CB152SST Discount Code A



DIRECT ACTING CONSTANT PRESSURE PUMP CONTROL VALVE WITH TAPPINGS - Reduces rapid pump cycling and maintains a pre-set operating pressure for pump systems. NPT threaded 1" female I.D. and 1 1/4" male O.D. on inlet and outlet connections. Features a flow efficient globe style all stainless steel body & composite bell housing, Nylon reinforced Buna-N diaphragm. With two (2) 1/2" tappings for gage, pressure switch, and relief valve, and one (1) 3/4" tapping for water tank.

Temp Max: 180°F (80°C) Pressure Max 400 PSI
Factory set at 50 PSI

Dual Purpose Threads

SIZE	PART NO.	SPRING RANGE	LIST PRICE
1"F & 1 1/4" M	CB152001SST	15 - 75 PSI	\$ 418
1"F & 1 1/4" M	CB152101SST	15 - 150 PSI	\$ 418

**CYCLE GARD® CI
CIN101** Discount Code **A**



CONSTANT PRESSURE PUMP CONTROL VALVE
Reduces rapid pump cycle with field adjustable by-pass and maintains a pre-set operating downstream pressure. Ideal for irrigation, water wells and agriculture.

Temp Max: 180°F (80°C) Pressure Max 250 PSI
Factory set at 50 PSI

SIZE	PART NO. THREADED	LIST PRICE
1 1/2"	CIN1020C	\$ 1,222
2"	CIN1020D	\$ 1,416

Max. pressure differential between inlet and outlet pressure 125 PSI. Consult factory for higher pressure differential.

**CYCLE GARD® CI²
CIN101-2** Discount Code **A**



CONSTANT PRESSURE PUMP CONTROL VALVE
Reduces rapid pump cycle and maintains a pre-set operating downstream pressure. Ideal for irrigation, water wells and agriculture. Built in by-pass at 5 GPM.

Temp Max: 180°F (80°C) Pressure Max 250 PSI
Factory set at 50 PSI

SIZE	PART NO. THREADED	LIST PRICE
1 1/2"	CIN1020C2	\$ 1,095
2"	CIN1020D2	\$ 1,151

Max. pressure differential between inlet and outlet pressure 125 PSI. Consult factory for higher pressure differential.

**CYCLE GARD®
C153S6** Discount Code **A**



CONSTANT PRESSURE PUMP CONTROL VALVE
Reduces rapid pump cycling and maintains a preset system operating pressure independent from low or high flow conditions. Valve body is all stainless steel female NPT connection. The valve supports a hanging load up to 3,400 lbs. and fits in a 4" well casing. Dual purpose 1" female & 1 1/4" male design is rated for 1 - 20 GPM. The full port 1 1/4" female design is rated for 2 - 50 GPM.

Temp Max: 180°F Max shut off pressure: 150 PSI

PLEASE NOTE: The valve setting must be below the pressure switch off setting. Consult O&M manual for proper installation.

40 PSI Configuration

SIZE	PART NO.	BYPASS	LIST PRICE
1"F & 1 1/4"M	C153002S6A	1	\$ 383
1"F & 1 1/4"M*	C153002S6-3A*	3	\$ 383
1 1/4"F	C153003S6A	1	\$ 574
1 1/4"F*	C153003S6-3A*	3	\$ 574

50 PSI Configuration

SIZE	PART NO.	BYPASS	LIST PRICE
1"F & 1 1/4"M	C153002S6	1	\$ 383
1"F & 1 1/4"M*	C153002S6-3*	3	\$ 383
1 1/4"F	C153003S6	1	\$ 574
1 1/4"F*	C153003S6-3*	3	\$ 574

60 PSI Configuration

SIZE	PART NO.	BYPASS	LIST PRICE
1"F & 1 1/4"M	C153002S6B	1	\$ 383
1"F & 1 1/4"M*	C153002S6-3B*	3	\$ 383
1 1/4"F	C153003S6B	1	\$ 574
1 1/4"F*	C153003S6-3B*	3	\$ 574

70 PSI Configuration

SIZE	PART NO.	BYPASS	LIST PRICE
1"F & 1 1/4"M	C153002S6C	1	\$ 383
1"F & 1 1/4"M*	C153002S6-3C*	3	\$ 383

*3 GPM bypass, recommended for 3 HP and 5 HP pump.

BENEFITS AND FEATURES

- ▶ Maintains a Constant Pressure
- ▶ Stops Pump from Cycling
- ▶ Hydraulically Operated (no electricity required)
- ▶ Extends the Life of the Pump
- ▶ Eliminates Effects of Water Hammer
- ▶ Many Models Available for Various Applications
- ▶ Easy to Install
- ▶ Field Adjustable
- ▶ Downsize the Tank
- ▶ Provides More Efficient Use of Appliances
- ▶ 3-Year Warranty

SELF CLEANING



- ▶ Slotted seat
- ▶ Self-cleaning
- ▶ No screen



FLOMATIC VALVES IS AN ACTIVE MEMBER IN THESE INDUSTRY ASSOCIATIONS AND OTHERS



MINIAIR® Discount Code **B**



MINIAIR® - Cast iron fusion bonded epoxy coated body-stainless steel trim. Threaded female x female connections. Stainless seat with Viton o-ring. Small orifice. Vents under line pressure.

Temp Max: 150°F (65°C) Inlet

Inlet Pressure MIN: 20 PSI*
Inlet Pressure MAX: 150 PSI*

SIZE	OUTLET	PART NO.	WGT.	LIST PRICE
3/8"	3/8"	6500	7	\$ 234
1/2"	3/8"	6501	7	\$ 261
3/4"	3/8"	6502	7	\$ 289
1"	1/2"	6503	7	\$ 322
2"	1/2"	6504	45	\$ 994

CONSULT FACTORY for full line of sizes available.

MAXIAIR® Discount Code **B**



MAXIAIR® - Cast iron body-stainless steel trim. Threaded female x female connections. NITRILE (Buna-N) seat. Large orifice vents on filling- eliminates vacuum under pressure loss.

Temp Max: 150°F (65°C)

Inlet Pressure MIN: 20 PSI*
Inlet Pressure MAX: 150 PSI*

SIZE	OUTLET	PART NO.	WGT.	LIST PRICE
1/2"	1/2"	6520	8	\$ 504
1"	1"	6521	16	\$ 656
2"	2"	6522	44	\$ 1,100
3"	3"	6523	75	\$ 1,596
4"	4"	6524	154	\$ 2,845
6"	6"	6525	174	\$ 3,962

CONSULT FACTORY for full line of sizes available.

MINIAIR® AIS Discount Code **B**



MINIAIR® AIS - Ductile iron fusion bonded epoxy coated body with two bolt access cover and stainless steel trim. Threaded female x female connections. Stainless seat with Viton o-ring. Small orifice. Vents under line pressure.

Temp Max: 150°F (65°C) Inlet

Inlet Pressure MIN: 20 PSI*
Inlet Pressure MAX: 150 PSI*



SIZE	OUTLET	PART NO.	WGT.	LIST PRICE
3/8"	3/8"	3500	7	\$ 340
1/2"	3/8"	3501	7	\$ 344
3/4"	3/8"	3502	7	\$ 384
1"	1/2"	3503	7	\$ 430

CONSULT FACTORY for full line of sizes available.

MAXIAIR® AIS Discount Code **B**



MAXIAIR® AIS - Ductile iron fusion bonded epoxy coated body with two bolt access cover and stainless steel trim. Threaded female x female connections. NITRILE (Buna-N) seat. Large orifice vents on filling- eliminates vacuum under pressure loss.

Temp Max: 150°F (65°C)

Inlet Pressure MIN: 20 PSI*
Inlet Pressure MAX: 150 PSI*



SIZE	OUTLET	PART NO.	WGT.	LIST PRICE
1/2"	1/2"	3520	8	\$ 630
1"	1"	3521	16	\$ 844

CONSULT FACTORY for full line of sizes available.

WELLAIR® Discount Code **B**



WELLAIR® - Similar to Maxiair® but features discharge throttling valve. Ideal for deep well applications.

Temp Max: 150°F (65°C)

Inlet Pressure MIN: 20 PSI*
Inlet Pressure MAX: 150 PSI*

SIZE	OUTLET	PART NO.	WGT.	LIST PRICE
1/2"	1/2"	6560	8	\$ 868
1"	1"	6561	18	\$ 1,040
2"	2"	6562	50	\$ 1,484
3"	3"	6563	109	\$ 2,527

CONSULT FACTORY for full line of sizes available.

COMBOAIR® Discount Code **B**



COMBOAIR® - Cast iron body-stainless steel trim. Combines features of Miniair® and Maxiair® in one housing.

Temp Max: 150°F (65°C)

Inlet Pressure MIN: 20 PSI*
Inlet Pressure MAX: 150 PSI*

SIZE	OUTLET	PART NO.	WGT.	LIST PRICE
1"	1"	6540	27	\$ 776
2"	2"	6541	72	\$ 1,337
3"	3"	6542	114	\$ 3,139
4"	4"	6543	177	\$ 4,014

CONSULT FACTORY for full line of sizes available.

6BSE BUG SCREEN Discount Code **B**



6BSE BUG SCREEN - Unleaded bronze body with threaded female connection. Plastic strainer for 1/2" size, stainless steel for 1" - 3", included with nipple for installation into air vent.

SIZE	PART NO.	WGT.	LIST PRICE
1/2"	4399E-1	0.2	\$ 31
1"	4301E-1	1.2	\$ 34
2"	4304E-1	2.8	\$ 90
3"	4306E-1	7.7	\$ 200

All Air Release, Air & Vacuum and Universal Combination Valves meet or exceed AWWA C512 standards.

IF YOU REQUIRE ASSISTANCE ORDERING AIR RELEASE VALVES, PLEASE CONTACT OUR CUSTOMER SERVICE REPRESENTATIVES AT 800.833.2040

***For alternate low or high pressure applications consult factory.**

Some valves are painted with TNEMEC red. Consult factory for fusion bonded epoxy coated option.

SEWAIR-MINI® Discount Code **B**



SEWAIR-MINI® - Cast iron body, 303 stainless steel trim. Threaded female x female connections. NITRILE (Buna-N) seat. ¼" orifice-for waste water application. Vents under line pressure.

Temp Max: 150 °F (65 °C)

Inlet Pressure MIN: 20 PSI*
Inlet Pressure MAX: 150 PSI*

SIZE	OUTLET	PART NO.	WGT.	LIST PRICE
2"	½"	6600	50	\$ 960
3"	½"	6601	70	\$ 1,421

CONSULT FACTORY for full line of sizes available.

For unit with backflush attachment, add "BF" to end of part number and add list price. See Backflush on this page.

For 316SS trim, add ST to the end of the part # and 20% to the list price.

SEWAIR-MAXI® Discount Code **B**



SEWAIR-MAXI® - Cast iron body, 303 stainless steel trim. Threaded female x female connections. NITRILE (Buna-N) seat. Large orifice-equals inlet size vents on filling. Eliminates vacuum in waste water pipeline under pressure loss.

Temp Max: 150 °F (65 °C)

Inlet Pressure MIN: 20 PSI*
Inlet Pressure MAX: 150 PSI*

SIZE	OUTLET	PART NO.	WGT.	LIST PRICE
2"	1"	6620	50	\$ 1,213
2"	2"	6621	82	\$ 2,295
3"	3"	6622	85	\$ 2,895
4"	4"	6623	120	\$ 3,887
6"	6"	6624	210	\$ 6,521

CONSULT FACTORY for full line of sizes available.

For unit with backflush attachment, add "BF" to end of part number and add list price. See Backflush on this page.

FEATURES AND BENEFITS

- ▶ Automatic
- ▶ Improves Flow & Pump Efficiency
- ▶ Eliminates Restrictive Air or Gas Pockets
- ▶ Saves Energy
- ▶ Protects Against Vacuum
- ▶ Long Body Protects Orifice From Sewage
- ▶ Compliance with AWWA C512



SEWAIR-DUAL® Discount Code **B**



SEWAIR-DUAL® - Cast iron body, 303 stainless steel trim. NITRILE (Buna-N) seat. Provides protection of both small and large orifices. Two body construction.

Temp Max: 150 °F (65 °C)

Inlet Pressure MIN: 20 PSI*
Inlet Pressure MAX: 150 PSI*

SIZE	OUTLET	PART NO.	WGT.	LIST PRICE
2"	1"	6640	120	\$ 3,868
2"	2"	6641	150	\$ 4,400

CONSULT FACTORY for full line of sizes available.

For unit with backflush attachment, add "BF" to end of part number and add list price. See Backflush on this page.

SEWAIR-COMBO® Discount Code **B**



SEWAIR-COMBO® - Cast iron body, 303 stainless steel trim. NITRILE (Buna-N) seat. Provides same protection as Sewair-Dual®, but combines into one body.

Temp Max: 150 °F (65 °C)

Inlet Pressure MIN: 20 PSI*
Inlet Pressure MAX: 150 PSI*

SIZE	OUTLET	PART NO.	WGT.	LIST PRICE
2"	1"	6650	80	\$ 2,329
2"	2"	6651	110	\$ 3,499
3"	3"	6652	145	\$ 4,748

CONSULT FACTORY for full line of sizes available.

For unit with backflush attachment, add "BF" to end of part number and add list price. See Backflush on this page.

BACKFLUSH® Discount Code **B**



BACKFLUSH® - Fabric reinforced NITRILE (Buna-N) hose with bronze shut off valves and galvanized quick disconnects. Designed for pressure backflush Sewair models.

INLET	PART NO.	WGT.	LIST PRICE
2"	BF2	12	\$ 694
3"	BF3	19	\$ 890

CONSULT FACTORY for full line of sizes available.

***For alternate low or high pressure applications consult factory.**

Some valves are painted with TNEPEC red. Consult factory for fusion bonded epoxy coated option.

Glen-Flo® Backflow Products

GFAVB Discount Code **C**



ATMOSPHERIC VACUUM BREAKER - Designed to prevent back-siphonage. Not for potable water.

Temp Max: 180°F (80°C) Pressure Max: 125 PSI
Complies with ASSE 1001

SIZE	PART NO.	WGT.	LIST PRICE
½"	GF3599	1	\$ 69
¾"	GF3500	2	\$ 84
1"	GF3501	2	\$121

GF8080E Discount Code **C**



UNLEADED DUAL CHECK VALVE - Brass body with single union.

Temp Max: 180°F (80°C) Pressure Max: 150 PSI
Complies with ASSE 1024

SIZE	PART NO.	WGT.	LIST PRICE
½"	GF8089E	2	\$ 88
¾"	GF8080E	2	\$ 96
1"	GF8081E	2	\$112

Add "FC" to end of part number for copper sweat connection.
Note: Consult factory for additional connection configurations.

GF8080S6 Discount Code **C**



DUAL CHECK VALVE - 316 stainless steel body with single union.

Temp Max: 180°F (80°C) Pressure Max: 175 PSI
Complies with ASSE 1024

SIZE	PART NO.	WGT.	LIST PRICE
¾"	GF8080S6	1.4	\$ 186
1"	GF8081S6	1.4	\$ 195
1 ¼"	GF8082S6*	2.2	\$ 292

*Not ASSE approved

GFHB8 Discount Code **C**



HOSE CONNECTION VACUUM BREAKERS - Designed to prevent back-siphonage or backflow of water, with vandal resistant features.

Temp Max: 180°F (80°C) Pressure Max: 125 PSI
Complies with ASSE 1011

SIZE	PART NO.	WGT.	LIST PRICE
¾"	GF800E	.21	\$ 21

GF8200 Discount Code **C**



DUAL CHECK with ATMOSPHERIC VENT - Continuous pressure backflow preventer with an intermediate atmospheric vent, with double union ends. Complies with ASSE 1012, not for potable water.

Temp Max: 210°F (98C) Pressure Max: 175 PSI

SIZE	PART NO.	WGT.	LIST PRICE
¾"	GF8280	1.3	\$ 118

Note: Consult factory for additional connection configurations.

VISIT OUR WEBSITE AT
WWW.FLOMATIC.COM
OR CALL 800.833.2040

BACKFLOW PREVENTERS 800.833.2040

AWWA C515 Gate Valves

115FL

Discount Code **C**

FLANGED - Ductile iron resilient wedge gate valves which meet AWWA C515 standard, with stainless steel stem, class 150.

Temp Max: 140 °F (60 °C)

Pressure Max: 250 PSI

SIZE	PART NO.	WGT.	LIST PRICE
2"	8560	28	\$ 418
2 1/2"	8561	38	\$ 421
3"	8562	56	\$ 509
4"	8563	78	\$ 712
6"	8564	138	\$ 1,271
8"	8565	214	\$ 1,979
10"	8566	360	\$ 2,774
12"	8567	531	\$ 4,186
14"	8568	547	\$ 7,512
16"	8569	719	\$ 8,599

115PO

Discount Code **C**

PUSH-ON - Ductile iron resilient wedge gate valves which meet AWWA C515 standard, with stainless steel stem. Ring-type (push-on PVC pipe).

Temp Max: 140 °F (60 °C)

Pressure Max: 250 PSI

SIZE	PART NO.	WGT.	LIST PRICE
2"	8560RT	28	\$ 361
2 1/2"	8561RT	42	\$ 395
3"	8562RT	44	\$ 495
4"	8563RT	69	\$ 673
6"	8564RT	119	\$ 1,268
8"	8565RT	203	\$ 2,046
10"	8566RT	278	\$ 3,182
12"	8567RT	421	\$ 4,953

115MJ

Discount Code **C**

MECHANICAL JOINT - Ductile iron resilient wedge gate valves which meet AWWA C515 standard, with stainless steel stem, class 150, MJ flange.

Temp Max: 140 °F (60 °C)

Pressure Max: 250 PSI

SIZE	PART NO.	WGT.	LIST PRICE
2"	8560MJ	28	\$ 391
3"	8562MJ	44	\$ 651
4"	8563MJ	69	\$ 815
6"	8564MJ	119	\$ 1,462
8"	8565MJ	203	\$ 2,365
10"	8566MJ	278	\$ 3,473
12"	8567MJ	421	\$ 4,857
16"	8569MJ	656	\$ 7,602

2" operating nut standard on all C515 Gate Valves

For hand wheel add "HW" to the end of the part number and add 15% to list

AWWA C515 Gate Valves

115NPT

Discount Code **C**

THREADED - Ductile iron resilient wedge valve which meet AWWA 515 standard with SS stem with NPT threaded connections.

Temp Max: 140 °F (60 °C)

Pressure Max: 250 PSI

SIZE	PART NO.	WGT.	LIST PRICE
2"	8560NPT	20	\$ 327
3"	8562NPT	32	\$ 520
4"	8563NPT	47	\$ 695
6"	8564NPT	85	\$ 1,263

1090SY

Discount Code **C**

OUTSIDE SCREW & YOKE - Cast iron resilient wedge gate valves which meet AWWA C509 standard with bronze stem and are UL/FM listed, class 125.

Temp Max: 140 °F (60 °C)

Pressure Max: 175 PSI

Tapped & plugged

SIZE	PART NO.	WGT.	LIST PRICE
2 1/2"	84610SY	55	\$ 1,720
3"	84620SY	74	\$ 2,008
4"	84630SY	103	\$ 2,633
6"	84640SY	158	\$ 4,181
8"	84650SY	240	\$ 5,992
10"	84660SY	392	\$ 9,396

109NRS

Discount Code **C**

FLANGED - Ductile iron resilient wedge gate valves which meet AWWA C509 standard with bronze stem, class 150.

Temp Max: 140 °F (60 °C)

Pressure Max: 250 PSI

Tapped & plugged

SIZE	PART NO.	WGT.	LIST PRICE
2 1/2"	8461	51	\$ 960
3"	8462	67	\$ 1,113
4"	8463	88	\$ 1,225
6"	8464	138	\$ 1,880
8"	8465	214	\$ 2,804
10"	8466	360	\$ 4,134
12"	8467	531	\$ 5,202

All gate valves standard open left. Consult factory for right hand opening.

FLOMATIC VALVES IS AN ACTIVE MEMBER IN THESE INDUSTRY ASSOCIATIONS AND OTHERS



FLOMATIC SALES REPS

UNITED STATES

STATE	DOMESTIC WATER SYSTEMS	EMAIL	INDUSTRIAL	EMAIL	MUNICIPAL	EMAIL
Alabama	H2O Reps	gregh2orep@bellsouth.net	H2O Reps	gregh2orep@bellsouth.net	H2O Reps	gregh2orep@bellsouth.net
Alaska	Pacific NW Sales	pnws@msn.com	Pacific NW Sales	pnws@msn.com	Pacific NW Sales	pnws@msn.com
Arizona	Desert Pacific Sales	pyama.dps@gmail.com	Desert Pacific Sales	pyama.dps@gmail.com	Desert Pacific Sales	pyama.dps@gmail.com
Arkansas	DJC Sales	sales@dcsalesco.com	Flomatic	fromatic@fromatic.com	Flomatic	fromatic@fromatic.com
California	Desert Pacific Sales	pyama.dps@gmail.com	Desert Pacific Sales	pyama.dps@gmail.com	Desert Pacific Sales	pyama.dps@gmail.com
Colorado	Maples Sales & Service	gmaples@maplesales.com	Maples Sales & Service	gmaples@maplesales.com	Maples Sales & Service	gmaples@maplesales.com
Connecticut	Harmon & Co	greg.harmonco@gmail.com	Harmon & Co	greg.harmonco@gmail.com	Harmon & Co	greg.harmonco@gmail.com
Delaware	Hasco Sales	margo@hascosales.net	Hasco Sales	margo@hascosales.net	Hasco Sales	margo@hascosales.net
D.C	Hasco Sales	margo@hascosales.net	Hasco Sales	margo@hascosales.net	Hasco Sales	margo@hascosales.net
Florida	Welty Inc	dgwelte@gmail.com	Flomatic	fromatic@fromatic.com	Flomatic	fromatic@fromatic.com
Georgia	H2O Reps	gregh2orep@bellsouth.net	H2O Reps	gregh2orep@bellsouth.net	H2O Reps	gregh2orep@bellsouth.net
Hawaii	Hawaii Engineering	info@hiengineering.com	Hawaii Engineering	info@hiengineering.com	Hawaii Engineering	info@hiengineering.com
Idaho	Pacific NW Sales	pnws@msn.com	Pacific NW Sales	pnws@msn.com	Pacific NW Sales	pnws@msn.com
Illinois - North	Rep Rite Burk	jvalentine@repriteburk.com	Rep Rite Burk	pwil@repriteburk.com	Rep Rite Burk	pwil@repriteburk.com
- South	GeoStarr Marketing	rick@geostarr.com	GeoStarr Marketing	rick@geostarr.com	Flomatic	fromatic@fromatic.com
Indiana	Watermark Engineered	bboyer@watermarkeps.com	Watermark Engineered	bboyer@watermarkeps.com	Watermark Engineered	bboyer@watermarkeps.com
Iowa	GeoStarr Marketing	rick@geostarr.com	GeoStarr Marketing	rick@geostarr.com	Flomatic	fromatic@fromatic.com
Kansas	GeoStarr Marketing	rick@geostarr.com	GeoStarr Marketing	rick@geostarr.com	Flomatic	fromatic@fromatic.com
Kentucky	Watermark Engineered	bboyer@watermarkeps.com	Watermark Engineered	bboyer@watermarkeps.com	Watermark Engineered	bboyer@watermarkeps.com
Louisiana	DJC Sales	sales@dcsalesco.com	DJC Sales	sales@dcsalesco.com	Flomatic	fromatic@fromatic.com
Maine	Harmon & Co	greg.harmonco@gmail.com	Harmon & Co	greg.harmonco@gmail.com	Harmon & Co	greg.harmonco@gmail.com
Maryland	Hasco Sales	margo@hascosales.net	Hasco Sales	margo@hascosales.net	Hasco Sales	margo@hascosales.net
Massachusetts	Harmon & Co	greg.harmonco@gmail.com	Harmon & Co	greg.harmonco@gmail.com	Harmon & Co	greg.harmonco@gmail.com
Michigan	Herder Sales	therder@herdersales.com	RS Controls	rscontrols@rscontrols.com	RS Controls	rscontrols@rscontrols.com
Minnesota	Rep Rite Burk	bcutter@repriteburk.com	Rep Rite Burk	bcutter@repriteburk.com	Rep Rite Burk	bcutter@repriteburk.com
Mississippi	Flomatic	fromatic@fromatic.com	Flomatic	fromatic@fromatic.com	Flomatic	fromatic@fromatic.com
Missouri	GeoStarr Marketing	rick@geostarr.com	GeoStarr Marketing	rick@geostarr.com	GeoStarr Marketing	rick@geostarr.com
Montana	Pacific NW Sales	pnws@msn.com	Pacific NW Sales	pnws@msn.com	Pacific NW Sales	pnws@msn.com
Nebraska	GeoStarr Marketing	rick@geostarr.com	GeoStarr Marketing	rick@geostarr.com	Flomatic	fromatic@fromatic.com
Nevada	Desert Pacific Sales	pyama.dps@gmail.com	Desert Pacific Sales	pyama.dps@gmail.com	Desert Pacific Sales	pyama.dps@gmail.com
New Hampshire	Harmon & Co	greg.harmonco@gmail.com	Harmon & Co	greg.harmonco@gmail.com	Harmon & Co	greg.harmonco@gmail.com
New Jersey - North	Advanced Hydraulics	sales@ahreps.com	Advanced Hydraulics	sales@ahreps.com	Advanced Hydraulics	sales@ahreps.com
- South	Hasco Sales	margo@hascosales.net	Hasco Sales	margo@hascosales.net	Hasco Sales	margo@hascosales.net
New Mexico	Maples Sales & Service	gmaples@maplesales.com	Maples Sales & Service	gmaples@maplesales.com	Maples Sales & Service	gmaples@maplesales.com
New York	Group One	groupone_ne@yahoo.com	Group One	groupone_ne@yahoo.com	Group One	groupone_ne@yahoo.com
- NYC & Long Island	Advanced Hydraulics	sales@ahreps.com	Advanced Hydraulics	sales@ahreps.com	Advanced Hydraulics	sales@ahreps.com
North Carolina	Lewis Marketing	glenn@lewismarketinginc.com	Lewis Marketing	glenn@lewismarketinginc.com	Lewis Marketing	glenn@lewismarketinginc.com
North Dakota	Rep Rite Burk	apcutter@repriteburk.com	Rep Rite Burk	apcutter@repriteburk.com	Rep Rite Burk	apcutter@repriteburk.com
Ohio - North	WYNN Enterprise, LLC	wynnl@wynnenterprisellc.com	WYNN Enterprise, LLC	wynnl@wynnenterprisellc.com	Daman Superior	rstummer@damsansuperior.com
- South	WYNN Enterprise, LLC	wynnl@wynnenterprisellc.com	WYNN Enterprise, LLC	wynnl@wynnenterprisellc.com	WYNN Enterprises	wynnl@wynnenterprisellc.com
Oklahoma	DJC Sales	sales@dcsalesco.com	DJC Sales	sales@dcsalesco.com	Flomatic	fromatic@fromatic.com
Oregon	Pacific NW Sales	pnws@msn.com	Pacific NW Sales	pnws@msn.com	Pacific NW Sales	pnws@msn.com
Pennsylvania - West	WYNN Enterprise, LLC	wynnl@wynnenterprisellc.com	WYNN Enterprise, LLC	wynnl@wynnenterprisellc.com	WYNN Enterprises	wynnl@wynnenterprisellc.com
- East	Hasco Sales	margo@hascosales.net	Hasco Sales	margo@hascosales.net	Hasco Sales	margo@hascosales.net
Rhode Island	Harmon & Co	greg.harmonco@gmail.com	Harmon & Co	greg.harmonco@gmail.com	Harmon & Co	greg.harmonco@gmail.com
South Carolina	Lewis Marketing	glenn@lewismarketinginc.com	Lewis Marketing	glenn@lewismarketinginc.com	Lewis Marketing	glenn@lewismarketinginc.com
South Dakota	Rep Rite Burk	apcutter@repriteburk.com	Rep Rite Burk	apcutter@repriteburk.com	Rep Rite Burk	apcutter@repriteburk.com
Tennessee	H2O Reps	gregh2orep@bellsouth.net	H2O Reps	gregh2orep@bellsouth.net	H2O Reps	gregh2orep@bellsouth.net
Texas	DJC Sales	sales@dcsalesco.com	DJC Sales	sales@dcsalesco.com	TLP Solutions	inquiries@tplsolutions.net
Utah	Flo-Tech	rbw@fitechinc.biz	Flo-Tech	rbw@fitechinc.biz	Flo-Tech	rbw@fitechinc.biz
Vermont	Harmon & Co	greg.harmonco@gmail.com	Harmon & Co	greg.harmonco@gmail.com	Harmon & Co	greg.harmonco@gmail.com
Virginia	Hasco Sales	margo@hascosales.net	Hasco Sales	margo@hascosales.net	Hasco Sales	margo@hascosales.net
Washington	Pacific NW Sales	pnws@msn.com	Pacific NW Sales	pnws@msn.com	Pacific NW Sales	pnws@msn.com
West Virginia	WYNN Enterprise, LLC	wynnl@wynnenterprisellc.com	WYNN Enterprise, LLC	wynnl@wynnenterprisellc.com	WYNN Enterprises	wynnl@wynnenterprisellc.com
Wisconsin	Rep Rite Burk	jvalentine@repriteburk.com	Rep Rite Burk	pwil@repriteburk.com	Rep Rite Burk	pwil@repriteburk.com
Wyoming	Maples Sales & Service	gmaples@maplesales.com	Maples Sales & Service	gmaples@maplesales.com	Maples Sales & Service	gmaples@maplesales.com

CANADA

Alberta	Fluid Agency's	fluidagencys1@gmail.com	Fluid Agency's	fluidagencys1@gmail.com	Fluid Agency's	fluidagencys1@gmail.com
British Columbia	Fluid Agency's	fluidagencys1@gmail.com	Fluid Agency's	fluidagencys1@gmail.com	Fluid Agency's	fluidagencys1@gmail.com
Manitoba	Quadra Sales	orders@quadrassales.ca	Quadra Sales	orders@quadrassales.ca	Quadra Sales	orders@quadrassales.ca
NS, NB, PE, NFLD	Flomatic	fromatic@fromatic.com	Flomatic	fromatic@fromatic.com	Flomatic	fromatic@fromatic.com
Ontario	Trison Sales	sales@trisonsales.com	Trison Sales	sales@trisonsales.com	Trison Sales	sales@trisonsales.com
Quebec	Nimatec	nimatec@nimatec.com	Nimatec	nimatec@nimatec.com	Nimatec	nimatec@nimatec.com
Saskatchewan	Quadra Sales	orders@quadrassales.ca	Quadra Sales	orders@quadrassales.ca	Quadra Sales	orders@quadrassales.ca

LATIN AMERICA

LATIN AMERICA	MA Trading	latino@fromatic.com	MA Trading	latino@fromatic.com	MA Trading	latino@fromatic.com
---------------	------------	---------------------	------------	---------------------	------------	---------------------

FOR LISTING OF WORLDWIDE FLOMATIC SALES REP, VISIT OUR WEBSITE: WWW.FLOMATIC.COM

8 WAYS YOU CAN REACH US...

1. SALES & ORDER DESK	800-833-2040 Press 2	We love to help you with new orders and inquiries.
2. TECH SUPPORT	800-833-2040 Press 4	Our engineers are on stand-by for application/product support.
3. MARKETING DEPT.	800-833-2040 Press 3	Use this line to reach the sales & marketing group.
4. E-MAIL ORDERS	orders@flomatic.com	Quick and easy. Send us a message and communicate with us.
5. FAX ORDERS	800-314-3155 or 518-761-9798	A convenient way to fax us your orders and inquiries.
6. WEB SITE	www.flomatic.com	Our website will help you get the latest information on Flomatic.
7. PHONE	800-833-2040 or 518-761-9797	If you are out of the country or can't get through, try this line.
8. U.S. Mail	15 Pruyn's Island Drive Glens Falls, NY 12801-4424	Put it in an envelope and lick a stamp, it's that easy.

FOLLOW US ON:



FLOMATIC® CONDITIONS OF SALE

STANDARD TERMS OF SALE

PRICE

Prices at date of shipment will apply. Prices are subject to change without notice.

ACCEPTANCE

Orders are accepted subject to approval of credit. Delivery is subject to strikes, accidents, or other causes beyond our control.

ERRORS, SHORTAGES, ETC.

All claims for errors, shortages, damages, etc. must be made within 10 days of delivery.

CANCELLATIONS OF ORDERS

Orders for standard catalog products may be canceled only if notice is received prior to the date of shipment.

RETURNS

Merchandise in new and salable condition may be returned within one year after purchase on a freight prepaid basis for credit upon return authorization approval number, subject to inspection and acceptance at our plant. A 25% restocking charge and original freight allowance, if any, will be deducted from the credit. Special order products are nonreturnable, or at manufacturer's option.

MINIMUM NET ORDER
\$75.00

STANDARD TERMS
1% ten days, net 30

FREIGHT ALLOWANCE
A & C Code \$1,500
B Code F.O.B Factory

Discount does not apply to freight or miscellaneous charges.

WARRANTIES

LIMITED ONE (1)-YEAR WARRANTY (Complete Product Line)

Flomatic® Corporation warrants that its products are free from defects in materials and workmanship. Flomatic® will replace any valve covered by this warranty that is found to be defective within one year, unless otherwise stated below, from the time of sale. This warranty will be void if the product has been modified in any way by the purchaser, or is subjected to unreasonable use.

LIMITED THREE (3)- YEAR WARRANTY (Automatic Control Valves)

Flomatic® Corporation warrants that its Automatic Control Valves are free from defects in materials and workmanship for the period of three (3) years after shipment. Flomatic® will repair or replace any parts or components that are found to be defective within three years from the time of its shipment. Components utilized by Flomatic® but manufactured by others will be warranted only to the extent of the guarantee of that manufacturer. This warranty will be void if the valve or its controls have been modified without factory authorization or if it is subjected to unusual operating conditions or if it is used for an application other than which it is intended which were not described or specified at the time of purchase.

LIMITED FIVE (5)-YEAR WARRANTY (Enviro Check® and Enviro Foot Valves) Flomatic® warrants that its ENVIRO-CHECK® AND FOOT VALVES, in all sizes up to 4", are free from defects in materials and workmanship. Flomatic® will replace, upon return authorization approval number, any ENVIRO CHECK® OR ENVIRO FOOT VALVE covered by this warranty that is found to be defective within five years from the time of sale. This warranty will be void if the product has been modified in any way by the purchaser, or is subjected to unreasonable use. These limited warranties extend to the original purchase from Flomatic® only; they do not extend to any other purchaser or transferee.

EXCLUSION OF WARRANTIES

Flomatic® makes no warranties, expressed or implied, with respect to its valves, other than the expressed limited warranties described herein. The implied warranties of merchantability and fitness for a particular purpose are hereby disclaimed by Flomatic®. There are no warranties that extend beyond the description on the face hereof.

WARNING-NOT DESIGNED, INTENDED OR PERMITTED IN NUCLEAR FACILITY APPLICATIONS. FLOMATIC® VALVES ARE NOT DESIGNED OR ENGINEERED FOR USE IN ANY NUCLEAR FACILITY OR IN CONJUNCTION WITH ANY NUCLEAR FACILITY OR SUPPORT FACILITY. USE OF ANY OF FLOMATIC'S PRODUCTS IN ANY SUCH APPLICATION IS A MISUSE OF THESE PRODUCTS AND VOIDS ALL WARRANTIES CONTAINED HEREIN, EXPRESSED AND IMPLIED, OF MERCHANTABILITY AND FITNESS FOR PARTICULAR PURPOSE.

EXCLUSION OF INCIDENTAL AND CONSEQUENTIAL DAMAGES

In no event shall Flomatic® be liable for incidental or consequential damages, including but without limitation, damages of personal injuries resulting from the negligence of Flomatic®, which may arise from the manufacture, sale, purchase and /or use of Flomatic® valves. It being intended that purchaser's exclusive remedy is limited to replacement of defective products. Some states do not allow the exclusion or limitation of incidental or consequential damages, or limitation on how long an implied warranty lasts, so that the above limitations may not apply to you. Contact your distributor or Flomatic® at address shown if you have any questions about the coverage of this warranty or service under this warranty. This warranty gives you specific legal rights, and you may have other rights which vary from state to state.

NOTE: Flomatic® reserves the right the change and/or alter valve products without prior notice. Consult factory for valve specifications.





FLOMATIC® VALVES

Flomatic can accept no responsibility for possible errors in catalogs, brochures, and other printed material. Flomatic reserves the right to alter its products without notice. This also applies to products already on order provided that such alterations can be made without sub-sequential changes being necessary in specifications already agreed. All trademarks in this material are property of the respective companies.

15 Pruyn's Island Drive
Glens Falls, N.Y. 12801
800-833-2040
518-761-9797 • Fax 518-761-9798
www.flomatic.com
e-mail: flomatic@flomatic.com

DISTRIBUTION BY:

This book is covered under patent numbers 4,757,974/ 4,849,041/ 6,024,121/
6,581,633/ 4,971,093/ 9,879,791/ 10,781,662/ 7,128,088/ D718,429/ 8,978,696/
9,032,992/ 9,611,948 and other patents.

©2021 Flomatic Corporation

YPRICE21 7.5M