



Distributed by:  **MIFAB**®









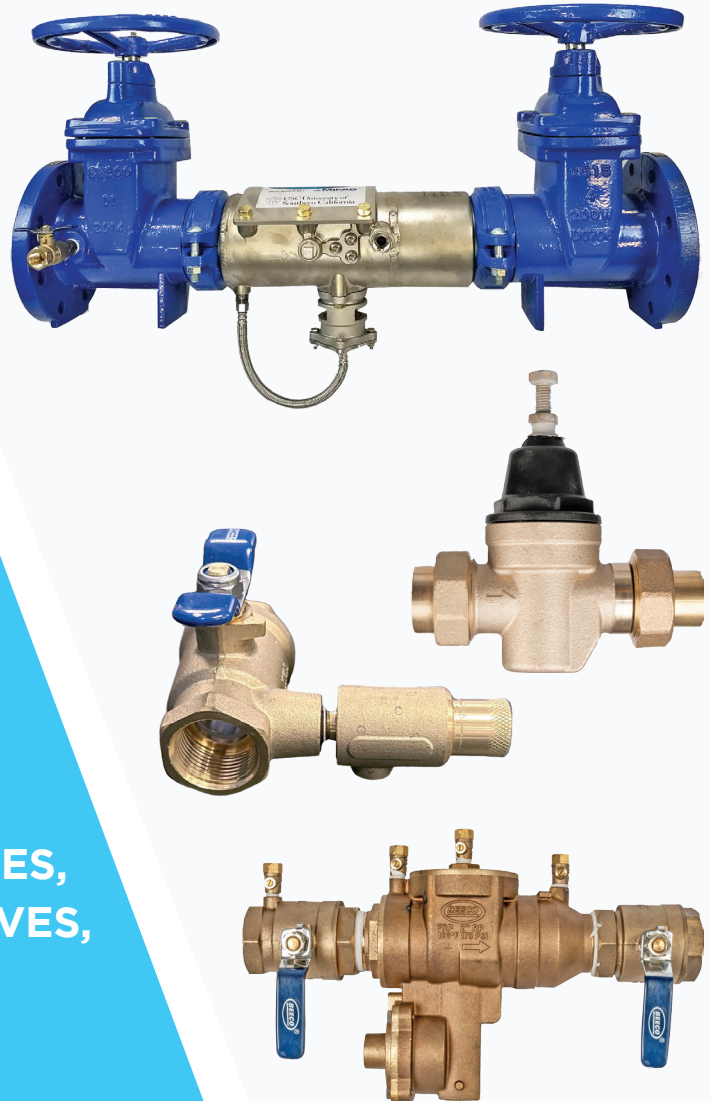























BEECO-2026

PRODUCTS CATALOG 2026

BACKFLOW PREVENTERS,
PRESSURE REDUCING VALVES,
AUTOMATIC CONTROL VALVES,
AND ACCESSORIES



LIT-071

 MI-CONTROL: PG 4	 HVB, HBVBSD: PG 5	 FPVB: PG 5	 PVB: PG 5	 DCAV: PG 6
 BPRV: PG 6	 BCOMBO: PG 6	 DC (DUAL CHECK): PG 6	 FDC: PG 8	 FDC: PG 9-11
 DCDA: PG 11	 BARRACUDA 20 FDC : PG 12-18	 FRP: PG 19	 FRP: PG 20-22	 RPDA: PG 23
 BARRACUDA 40 FRP : PG 24-30	 AIR GAP (AG) PG 31	 PRV: PG 32-35	 ACV: PG 36-38	 SCV: PG 38
 FLEX CHECK (FCV): PG 39	 GATE VALVES: PG 39-42	 DIELECTRIC UNIONS: PG 43	 STR-DI: PG 44	 STR-BRZ: PG 44
 AV-P: PG 45-47	 AV-WP: PG 48	 BALL VALVE: PG 49	 BACKFLOW REPAIR KITS : PG 50-54	 TEST KIT: PG 55
TROUBLE SHOOTING GUIDE: PG 55	CROSS REFERENCE: PG 56-59	ABBREVIATIONS: PG 60	TERMS AND CONDITIONS: PG 61	

"Mifab Products are by far the best, easy to install and so well thought out. No other manufacturer makes their products so simple to use. Mifab is the only way to go." - Joe Boyle, Boyle Plumbing & Contracting, Inc.

CALIFORNIA PROPOSITION 65 WARNING. This product contains chemicals known to the State of California to cause cancer and birth defects or other reproductive harm.

PRODUCT	PAGE NO.
MI-CONTROL THERMAL EXPANSION RELIEF VALVES.....	4
HVB, HBVBSD (HOSE CONNECTION VACUUM BREAKERS)	5
FPVB (PRESSURE VACUUM BREAKER).....	5
PVB (PRESSURE VACUUM BREAKERS)	5
DCAV (DUAL CHECK VALVES WITH ATMOSPHERIC VENT).....	6
BPRV (BOILER PRESSURE REDUCING VALVE)	6
BCOMBO (BOILER FEED WATER PRV AND COMBO BACKFLOW)	6
DC (DUAL CHECK VALVES)	6
FDC (SMALL 1/2" - 2") DOUBLE CHECK BACKFLOW PREVENTERS.....	8
FDC (LARGE 2 1/2" - 10") DOUBLE CHECK BACKFLOW PREVENTERS .	9-11
DCDA BACKFLOW PREVENTERS	11
BARRACUDA 20 FDC - LARGE - (2 1/2" - 8") BARRACUDA DOUBLE CHECK, STAINLESS STEEL BACKFLOW PREVENTERS	14-17
FRP (SMALL 1/2" - 2") REDUCED PRESSURE ZONE BACKFLOW PREVENTERS.....	19-20
FRP (LARGE 2 1/2" - 10") REDUCED PRESSURE ZONE BACKFLOW PREVENTERS.....	20-22
RPDA (2 1/2" - 10") DUCTILE IRON, BACKFLOW PREVENTERS WITH DETECTOR.....	23
BARRACUDA 40 FRP - BARRACUDA REDUCED PRESSURE ZONE, STAINLESS STEEL BACKFLOW PREVENTERS.....	26-29
REPLACEMENT CHECKS FOR BARRACUDA BACKFLOW PREVENTERS.	30
AG SERIES (AIR GAPS)	31
SPOOLS AND SPACERS	31
PRV (PRESSURE REDUCING VALVES).....	32-33
PRV-F - PRESSURE REDUCING VALVES COMPETITIVE FIELD REPLACEMENT	34
PRESSURE REDUCING VALVE UNION KITS	35
JK (JUMPER KITS) COMPACT DESIGN ONLY	35
REPAIR PARTS FOR ACV WITH -T.....	36
ACV (AUTOMATIC CONTROL VALVES).....	37
ACV (AUTOMATIC CONTROL VALVES).....	38
SCV (SILENT CHECK VALVES)	38

PRODUCT	PAGE NO.
FCV (FLEX CHECK VALVES).....	39
GV-OSY (GATE VALVES, OSY STYLE).....	39-41
GV-NRS (GATE VALVES, NRS STYLE).....	41-42
ECCENTRIC PLUG VALVES.....	43
DIELECTRIC UNIONS	43
STR-DI-PC (STRAINERS (2" - 12"), DUCTILE IRON, POWDER COATED).....	44
STR-IPS-LL (STRAINERS (1/2" - 2"), BRONZE, IPS).....	44
AIR RELEASE VALVES - MH SERIES.....	46
AIR RELEASE VALVES - MS SERIES.....	46
AIR RELEASE VALVES - AV (PLASTIC) SERIES	47
AIR RELEASE VALVES - WP SERIES	48
BV-IPS-BRZ (BALL VALVES, BRONZE SERIES).....	49
ACV - AUTOMATIC CONTROL VALVE REPAIR KITS	50
PRV - PRESSURE REDUCING VALVE REPAIR KITS	50
FDC-RK (DC BACKFLOW PREVENTERS, REPAIR KITS)	51
FRP-RK (RPZ BACKFLOW PREVENTERS, REPAIR KITS).....	51
ALL RUBBER SEATS, SEALS AND RELIEF VALVE PARTS.....	52
REPLACEMENT BACKFLOW PREVENTER CHECKS	52
FDC / FRP ASSEMBLIES.....	53
OLD HERSEY BEECO® REPAIR KITS	53
TK SERIES.....	55
BACKFLOW PREVENTER TROUBLE SHOOTING GUIDE.....	55
SMALL DIAMETER LEAD FREE BACKFLOW CROSS REFERENCE	56
BEECO® LARGE DIAMETER LEAD FREE BACKFLOW CROSS REFERENCE.....	57-59
ABBREVIATIONS	60
TERMS AND CONDITIONS	61

CALIFORNIA PROPOSITION 65 WARNING. This product contains chemicals known to the State of California to cause cancer and birth defects or other reproductive harm.

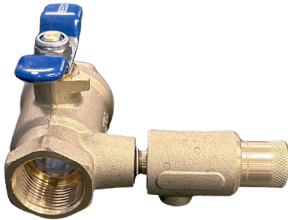
MI-CONTROL-NPT-LL (ILLUSTRATED)

 FOR SPEC. SHEETS GO TO
www.beecobackflow.com
APPROVALS:

 Tested and certified to IAPMO IGC 128-2019,
 CSA B125.3-2022 and listed with IAPMO

MI-CONTROL THERMAL EXPANSION RELIEF VALVES
NPT CONNECTIONS ADJUSTABLE FROM 80 PSI TO 125 PSI RELIEF

Model Number	Size	Qty. per Carton	Weight per Carton (Lbs.)	List Price (Each)
MI-CONTROL-NPT-LL	3/4"	20	25	\$76
MI-CONTROL-NPT-LL-C	3/4"	20	25	\$76

-C COMPRESSION DRAIN CONNECTION ASSEMBLED

MI-CONTROL-PEX-LL (ILLUSTRATED)

 FOR SPEC. SHEETS GO TO
www.beecobackflow.com
PEX CONNECTIONS ADJUSTABLE FROM 80 PSI TO 125 PSI RELIEF

Model Number	Size	Qty. per Carton	Weight per Carton (Lbs.)	List Price (Each)
MI-CONTROL-PEX-LL	3/4"	20	25	\$80
MI-CONTROL-PEX-B-LL	3/4"	20	25	\$81

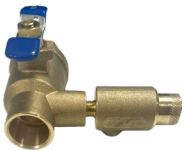
-B BARB DRAIN CONNECTION ASSEMBLED

MI-CONTROL-SWT-LL (ILLUSTRATED)

 FOR SPEC. SHEETS GO TO
www.beecobackflow.com
SWEAT CONNECTIONS ADJUSTABLE FROM 80 PSI TO 125 PSI RELIEF

Model Number	Size	Qty. per Carton	Weight per Carton (Lbs.)	List Price (Each)
MI-CONTROL-SWT-LL	3/4"	20	25	\$76
MI-CONTROL-SWT-B-LL	3/4"	20	25	\$77

-B BARB DRAIN CONNECTION ASSEMBLED
MI-CONTROL DRAIN PORT CONNECTIONS
3/8" Compression

1/2" PEX

(Crimp-style fitting designed to ASTM F1807)

3/8" Uponor

Barbed

UPONOR CONNECTIONS ADJUSTABLE FROM 80 PSI TO 150 PSI RELIEF

Model Number	Size	Qty. per Carton	Weight per Carton (Lbs.)	List Price (Each)
MI-CONTROL-UP-LL	3/4"	20	25	\$76

ADJUSTABLE REPLACEMENT RELIEF VALVE ADJUSTABLE FROM FROM 80 PSI TO 150 PSI

Model Number	Size	Qty. per Carton	Weight per Carton (Lbs.)	List Price (Each)
MI-CONTROL-RV	3/4"	1	1	\$55

Each MI-CONTROL is shipped with these five different drain port connections.

CALIFORNIA PROPOSITION 65 WARNING. This product contains chemicals known to the State of California to cause cancer and birth defects or other reproductive harm.

HVB, HBVBSD (HOSE CONNECTION VACUUM BREAKERS)

HOSE CONNECTION ATMOSPHERIC VACUUM BREAKER

Model Number	Size	Qty. per Carton	Weight per Carton (Lbs.)	List Price (Each)
HVB.75F-X-.75M-RB-LL	3/4"	1	1	\$16
HVB.75F-X-.75M-CP-LL	3/4"	1	1	\$17



HVB.75-X.75M-RB-LL (ILLUSTRATED)
FOR SPEC. SHEETS GO TO www.beecobackflow.com

SELF DRAINING HOSE VACUUM BREAKER

Model Number	Size	Qty. per Carton	Weight per Carton (Lbs.)	List Price (Each)
HBVBSD.75-CP-LL	3/4"	1	1	\$36
HBVBSD.75-RB-LL	3/4"	1	1	\$34



HBVBSD.75-RB-LL (ILLUSTRATED)
FOR SPEC. SHEETS GO TO www.beecobackflow.com

FPVB (PRESSURE VACUUM BREAKER)

WITH 1/4 TURN SHUT OFF VALVES

Model Number	Size	Qty. per Carton	Weight per Carton (Lbs.)	List Price (Each)
FPVB.50-QT-LL	1/2"	1	3	\$234.00
FPVB.75-QT-LL	3/4"	1	4	\$251.00
FPVB1.00-QT-LL	1"	1	5	\$318.00



FPVB.50-QT-LL (ILLUSTRATED)
FOR SPEC. SHEETS GO TO www.beecobackflow.com

MAXIMUM WORKING WATER PRESSURE and TEMPERATURE: 150 psi and 140°F (60°C)

PVB (PRESSURE VACUUM BREAKERS)

WITH 1/4 TURN SHUTOFF VALVES

Model Number	Size	Qty. per Carton	Weight per Carton (Lbs.)	List Price (Each)
PVB.50-QT-LL	1/2"	1	3	\$234
PVB.75-QT-LL	3/4"	1	4	\$251
PVB1.00-QT-LL	1"	1	5	\$318
PVB1.25-QT-LL	1 1/4"	1	8	\$843
PVB1.50-QT-LL	1 1/2"	1	9	\$954
PVB2.00-QT-LL	2"	1	10	\$1,155



COMPONENTS:
PVB2.00-QT-LL (ILLUSTRATED)
FOR SPEC. SHEETS GO TO www.beecobackflow.com

MAXIMUM WORKING WATER PRESSURE: 150 psi
TEMPERATURE RANGE 33F to 140F
Hydrastatic test pressure to 300 psi

CALIFORNIA PROPOSITION 65 WARNING. This product contains chemicals known to the State of California to cause cancer and birth defects or other reproductive harm.

COMPONENTS
DCAV.50-NPT (ILLUSTRATED)

 FOR SPEC. SHEETS GO TO www.beecobackflow.com
MAXIMUM WORKING WATER PRESSURE: 175 psi (12 Bar)

TEMPERATURE RANGE: 33F to 250F (0.5C to 121C)

APPROVALS:

Tested and approved to ASSE 1012-2009 & CSA B64.3-2011 and listed with IAPMO

DCAV (DUAL CHECK VALVES WITH ATMOSPHERIC VENT)
DUAL CHECK VALVE WITH ATMOSPHERIC VENT (BOILER FEED BACKFLOW VALVE)

Model Number	Size	Qty. per Carton	Weight per Carton (Lbs.)	List Price (Each)
DCAV.50-NPT	1/2"	1	2	\$140
DCAV.75-NPT	3/4"	1	2	\$140
DCAV.50-SWT	1/2"	1	2	\$140
DCAV.75-SWT	3/4"	1	2	\$140
DCAV-KIT	1/2", 3/4"	1	1	\$56

BPRV (BOILER PRESSURE REDUCING VALVE)
BOILER PRESSURE REDUCING VALVE

Model Number	Size	Qty. per Carton	Weight per Carton (Lbs.)	List Price (Each)
BPRV.50-NPT	1/2"	1	1	\$200.00
BPRV.75-NPT	3/4"	1	1	\$200.00
BPRV.50-SWT	1/2"	1	1	\$200.00
BPRV.75-SWT	3/4"	1	1	\$200.00

BPRV.75-NPT (ILLUSTRATED)
BCOMBO (BOILER FEED WATER PRV AND COMBO BACKFLOW)
BOILER FEED WATER PRV AND COMBO BACKFLOW

Model Number	Size	Qty. per Carton	Weight per Carton (Lbs.)	List Price (Each)
BCOMBO.50-NPT	1/2"	1	3	\$360.00
BCOMBO.75-NPT	3/4"	1	3	\$360.00
BCOMBO.50-SWT	1/2"	1	3	\$360.00
BCOMBO.75-SWT	3/4"	1	3	\$360.00

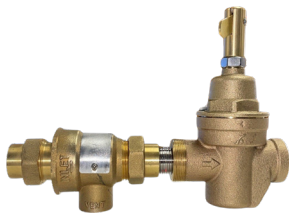
BCOMBO.75-NPT (ILLUSTRATED)

"I would attribute the majority of our business growth to MIFAB over the last two and a half years which is how long we have worked with them."
- Dan Thomas, Ben Thomas and Associated

DC.50-NPTX.50-NPT-LL (ILLUSTRATED)

 FOR SPEC. SHEETS GO TO www.beecobackflow.com

Maximum working water pressure 150 PSI.

Maximum working water temperature 140° F.

Hydrostatic test pressure 300 PSI.

MATERIALS: Main valve body Cast Bronze ASTM B584, Fasteners Stainless Steel, 300 Series.

Elastomers Silicone (FDA approved), Buna Nitrile (FDA approved), Polymers Polypropylene (FDA approved).

Delrin® (FDA approved), Springs Stainless Steel, 300 series.

DC (DUAL CHECK VALVES)
FEMALE NPT BY FEMALE NPT

Model Number	Size	Qty. per Carton	Weight per Carton (Lbs.)	List Price (Each)
DC.50-NPTX.50-NPT-LL	1/2"	1	1.5	\$88
DC.75-NPTX.75-NPT-LL	3/4"	1	1.6	\$88
DC1.0-NPTX.75-NPT-LL	1" Inlet by 3/4"	1	1.7	\$93
DC1.0-NPTX1.0-NPT-LL	1"	1	2	\$95

FEMALE SWT INLET BY FEMALE NPT

Model Number	Size	Qty. per Carton	Weight per Carton (Lbs.)	List Price (Each)
DC.50-SWTX.50-NPT-LL	1/2"	1	1.5	\$88
DC.75-SWTX.75-NPT-LL	3/4"	1	1.6	\$88
DC1.0-SWTX.75-NPT-LL	1" Inlet by 3/4"	1	1.7	\$93
DC1.0-SWTX1.0-NPT-LL	1"	1	2	\$95

"Plumbers like BEECO® products it's comparable with the competitors product and a great product well-made works well!" - Terry Zhang, L.C. Plumbing & Electrical Supply

CALIFORNIA PROPOSITION 65 WARNING. This product contains chemicals known to the State of California to cause cancer and birth defects or other reproductive harm.

BEECO® FRIENDLY DOUBLE CHECK BACKFLOW PREVENTERS

USC
APPROVED

1/2" - 10"

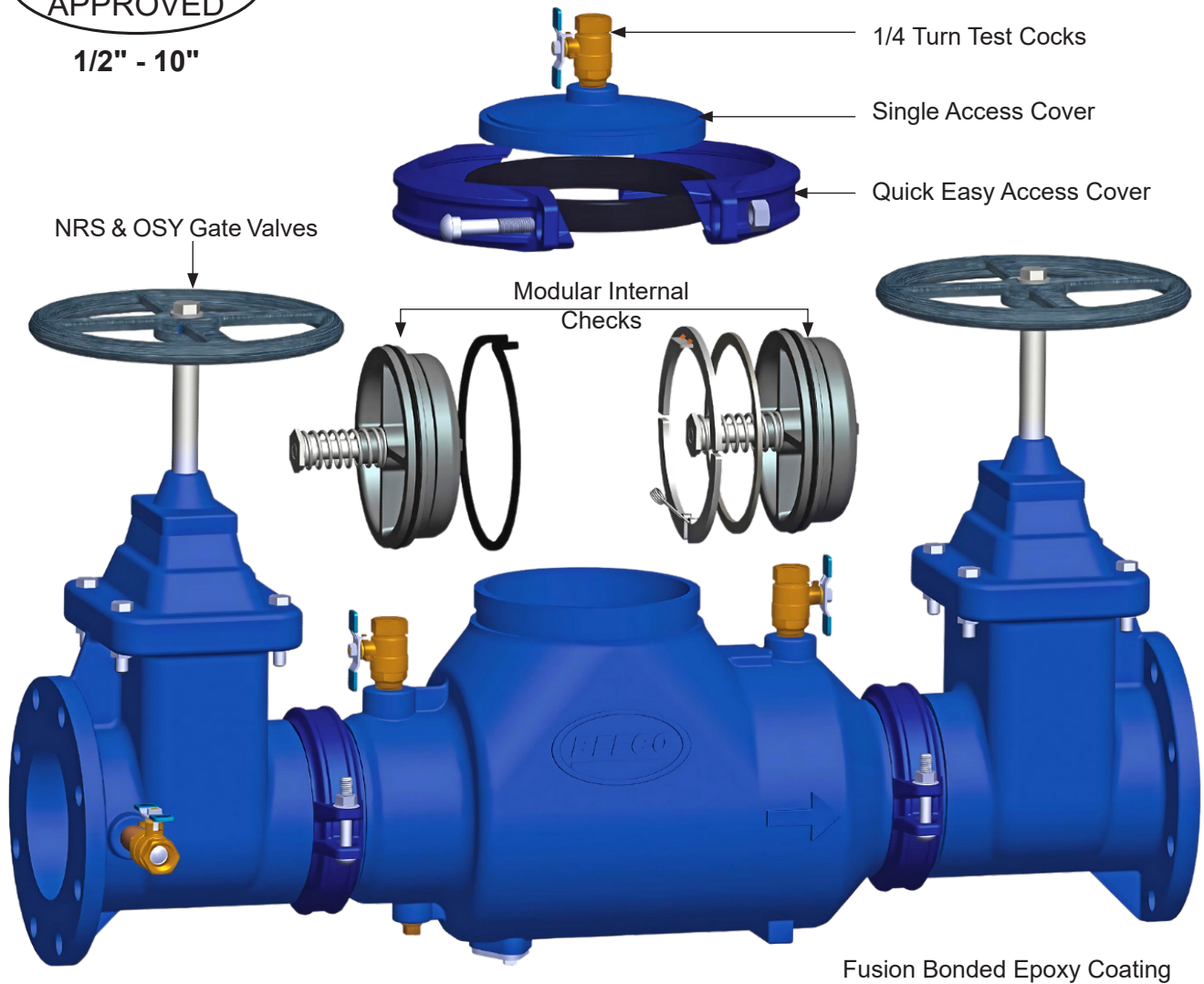

FEATURES AND BENEFITS:

The new modern redesigned BEECO® Friendly Double Check Valve was designed with input from hundreds of plumbers, and many backflow specialists were involved. It was designed with ease of access and a dramatic reduction in the spare parts needed. The light weight short lay length modular design makes this valve the easiest and quickest valve to perform your mandatory yearly certification on. For a complete list of all our features and benefits, see our website: www.beecobackflow.com. The BEECO® Double Check Valve is available with a detector check bypass and flow meter used on fire lines. See the DCDA product offering.

"MIFAB's plant is huge and they always have everything ready and available for us."

- Dan Thomas of Ben Thomas and Associates, Shade Gap, PA

CALIFORNIA PROPOSITION 65 WARNING. This product contains chemicals known to the State of California to cause cancer and birth defects or other reproductive harm.

FDC (SMALL 1/2" - 2") DOUBLE CHECK BACKFLOW PREVENTERS

DOUBLECHECKBACKFLOWPREVENTER,LOWLEADBRONZEBOY

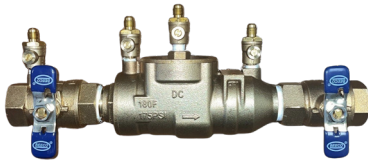
FDC.75-QT-LL (ILLUSTRATED)

 FOR SPEC. SHEETS GO TO
www.beecobackflow.com

APPROVALS:

 Tested and certified to ASSE 1015-2011
 and CSA B64.0 and listed with IAPMO

 Double Check Backflow Preventers
 are designed to protect against
 contamination of potable water.

 Installation and selection of the proper
 device should be made by a qualified
 licensed professional.

 All Low Lead models are in compliance
 with Section 1417(d) of the Safe
 Drinking Water Act, and the lead content
 requirements of Section 116875 of the
 California Health & Safety Code; CA
 1953 and VT S. 152 low lead laws.

FDC.75-QT-S-LL (ILLUSTRATED)

 FOR SPEC. SHEETS GO TO
www.beecobackflow.com
WITH 1/4 TURN SHUTOFF VALVES

Model Number	Size	Qty. per Carton	Weight per Carton (Lbs.)	List Price (Each)
FDC.50-QT-LL	1/2"	1	4	\$311
FDC.75-QT-LL	3/4"	1	4.5	\$353
FDC1.00-QT-LL	1"	1	6.4	\$515
FDC1.25-QT-LL	1 1/4"	1	10	\$902
FDC1.50-QT-LL	1 1/2"	1	12	\$1,058
FDC2.00-QT-LL	2"	1	19	\$1,653

* See page 61 for Cross Reference to competitor's models

WITH 1/4 TURN SHUTOFF AND LOCKING HANDLES

Model Number	Size	Qty. per Carton	Weight per Carton (Lbs.)	List Price (Each)
FDC.50-QT-LH-LL	1/2"	1	4	\$343
FDC.75-QT-LH-LL	3/4"	1	4.5	\$389
FDC1.00-QT-LH-LL	1"	1	6.4	\$567
FDC1.25-QT-LH-LL	1 1/4"	1	10	\$992
FDC1.50-QT-LH-LL	1 1/2"	1	12	\$1,165
FDC2.00-QT-LH-LL	2"	1	19	\$1,819

* See page 61 for Cross Reference to competitor's models

WITH 1/4 TURN SHUTOFFS AND STAINLESS STEEL HANDLES

Model Number	Size	Qty. per Carton	Weight per Carton (Lbs.)	List Price (Each)
FDC.50-QT-SH-LL	1/2"	1	4	\$343
FDC.75-QT-SH-LL	3/4"	1	4.5	\$389
FDC1.00-QT-SH-LL	1"	1	6.4	\$567
FDC1.25-QT-SH-LL	1 1/4"	1	10	\$992
FDC1.50-QT-SH-LL	1 1/2"	1	12	\$1,165
FDC2.00-QT-SH-LL	2"	1	19	\$1,819

* See page 61 for Cross Reference to competitor's models

WITH 1/4 TURN SHUTOFF AND WYE TYPE STRAINER

Model Number	Size	Qty. per Carton	Weight per Carton (Lbs.)	List Price (Each)
FDC.50-QT-S-LL	1/2"	1	4.9	\$342
FDC.75-QT-S-LL	3/4"	1	5.3	\$399
FDC1.00-QT-S-LL	1"	1	7.5	\$590
FDC1.25-QT-S-LL	1 1/4"	1	11.5	\$1,011
FDC1.50-QT-S-LL	1 1/2"	1	14	\$1,216
FDC2.00-QT-S-LL	2"	1	22	\$1,907

* See page 61 for Cross Reference to competitor's models

CALIFORNIA PROPOSITION 65 WARNING. This product contains chemicals known to the State of California to cause cancer and birth defects or other reproductive harm.

FDC (LARGE 2 1/2" - 10") DOUBLE CHECK BACKFLOW PREVENTERS

WITH DUCTILE IRON SHUTOFFS AND LEAD FREE COMPONENTS WITH NRS RESILIENT SEATED SHUTOFF VALVES AND FLANGED CONNECTIONS

Model Number	Size	Qty. per Carton	Weight per Carton (Lbs.)	List Price (Each)
FDC2.50-NRS	2 1/2"	1	183	\$4,187
FDC3.00-NRS	3"	1	200	\$4,347
FDC4.00-NRS	4"	1	222	\$4,948
FDC6.00-NRS	6"	1	380	\$7,669
FDC8.00-NRS	8"	1	900	\$21,177
FDC10.00-NRS	10"	1	1170	\$25,507

* See pages 62-63 for Cross Reference to competitor's models



2 1/2" - 10"



FDC4.00-NRS (ILLUSTRATED)
FOR SPEC. SHEETS GO TO
www.beecobackflow.com



BEECO® Double Check Backflow Preventers are designed to protect against contamination of potable water.

Installation and selection of the proper device should be made by a qualified licensed professional.

The BEECO® FDC Series is certified and tested to ASSE 1015-2011 and CSA B64.0 and listed with IAPMO

All devices are AWWA compliant.

FDC (LARGE 2 1/2" - 10) DOUBLE CHECK BACKFLOW PREVENTERS MEET BUY AMERICA AND PSA STANDARDS WITH SUFFIX -BA / -PSA SELECTED

NRS RESILIENT SEATED SHUTOFF VALVES, FLANGED CONNECTIONS COMPLIES WITH THE BUY AMERICA ACT

Model Number	Size	Qty. per Carton	Weight per Carton (Lbs.)	List Price (Each)
FDC2.50-NRS-BA	2 1/2"	1	183	P.O.A.
FDC3.00-NRS-BA	3"	1	200	P.O.A.
FDC4.00-NRS-BA	4"	1	222	P.O.A.
FDC6.00-NRS-BA	6"	1	380	P.O.A.
FDC8.00-NRS-BA	8"	1	900	P.O.A.
FDC10.00-NRS-BA	10"	1	1170	P.O.A.

* See pages 62-63 for Cross Reference to competitor's models



APPROVALS:

Tested and certified to ASSE 1015-2011 and CSA B64.0 and listed with IAPMO

"The product we have sold is well built.. I have no call backs on the units that we have in the field at Ft. Indiantown Gap Army Depot and the catalog is an easy read to find the product"

- Dave Roberts, Maryland Pipe & Supply

CALIFORNIA PROPOSITION 65 WARNING. This product contains chemicals known to the State of California to cause cancer and birth defects or other reproductive harm.

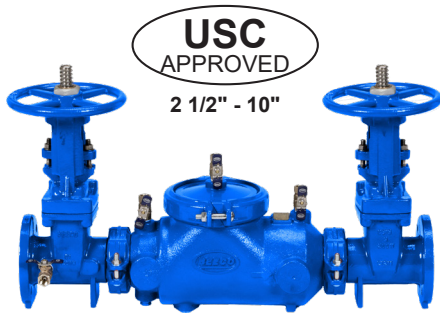

FDC3.00-OSY (ILLUSTRATED)
FOR SPEC. SHEETS GO TO
www.beecobackflow.com



FDC3.00-NRS (ILLUSTRATED)
FOR SPEC. SHEETS GO TO
WWW.BEECOBACKFLOW.COM

FDC (LARGE 2 1/2" - 10") DOUBLE CHECK BACKFLOW PREVENTERS
OSY RESILIENT SEATED SHUTOFF VALVES, FLANGED CONNECTIONS IS UL LISTED AND APPROVED

Model Number	Size	Qty. per Carton	Weight per Carton (Lbs.)	List Price (Each)
FDC2.50-OSY-UL	2 1/2"	1	191	\$4,404
FDC3.00-OSY-UL	3"	1	206	\$4,461
FDC4.00-OSY-UL	4"	1	237	\$5,049
FDC6.00-OSY-UL	6"	1	386	\$7,646
FDC8.00-OSY-UL	8"	1	950	\$21,883
FDC10.00-OSY-UL	10"	1	1270	\$26,130

* See pages 62-63 for Cross Reference to competitor's models

WITH NRS RESILIENT SEATED SHUTOFF VALVES, FLANGED WITH A STRAINER

Model Number	Size	Qty. per Carton	Weight per Carton (Lbs.)	List Price (Each)
FDC2.50-NRS-S	2 1/2"	1	219	\$4,605
FDC3.00-NRS-S	3"	1	243	\$4,911
FDC4.00-NRS-S	4"	1	290	\$5,616
FDC6.00-NRS-S	6"	1	540	\$9,173
FDC8.00-NRS-S	8"	1	1175	\$23,435
FDC10.00-NRS-S	10"	1	1580	\$29,268

* See pages 62-63 for Cross Reference to competitor's models

WITH GROOVED CONNECTIONS WITH NRS RESILIENT SEATED SHUTOFF VALVES AND GROOVED CONNECTIONS

Model Number	Size	Qty. per Carton	Weight per Carton (Lbs.)	List Price (Each)
FDC2.50-NRS-G	2 1/2"	1	174	\$4,188
FDC3.00-NRS-G	3"	1	190	\$4,349
FDC4.00-NRS-G	4"	1	211	\$4,950
FDC6.00-NRS-G	6"	1	361	\$7,672
FDC8.00-NRS-G	8"	1	880	\$21,188
FDC10.00-NRS-G	10"	1	1140	\$25,517

* See pages 62-63 for Cross Reference to competitor's models

CALIFORNIA PROPOSITION 65 WARNING. This product contains chemicals known to the State of California to cause cancer and birth defects or other reproductive harm.

FDC (LARGE 2 1/2" - 10") DOUBLE CHECK BACKFLOW PREVENTERS

OSY RESILIENT SEATED SHUTOFF VALVES, GROOVED CONNECTIONS COMPLIES AND IS LISTED TO UL

Model Number	Size	Qty. per Carton	Weight per Carton (Lbs.)	List Price (Each)
FDC2.50-OSY-G-UL	2 1/2"	1	181	\$4,624
FDC3.00-OSY-G-UL	3"	1	196	\$4,684
FDC4.00-OSY-G-UL	4"	1	225	\$5,302
FDC6.00-OSY-G-UL	6"	1	367	\$8,028
FDC8.00-OSY-G-UL	8"	1	930	\$22,977
FDC10.00-OSY-G-UL	10"	1	1240	\$27,437

* See pages 62-63 for Cross Reference to competitor's models

DOUBLE CHECK BACKFLOW PREVENTER, LESS GATE VALVES, GROOVED CONNECTIONS

Model Number	Size	Qty. per Carton	Weight per Carton (Lbs.)	List Price (Each)
FDC2.50-LF	2 1/2"	1	72	\$4,114
FDC3.00-LF	3"	1	72	\$4,114
FDC4.00-LF	4"	1	72	\$4,114
FDC6.00-LF	6"	1	150	\$7,470
FDC8.00-LF	8"	1	360	\$10,020
FDC10.00-LF	10"	1	360	\$14,043

* See pages 62-63 for Cross Reference to competitor's models

DCDA BACKFLOW PREVENTERS

OSY RESILIENT SEATED SHUTOFF VALVES, FLANGED CONNECTIONS COMPLIES AND IS LISTED TO UL

Model Number	Size	Qty. per Carton	Weight per Carton (Lbs.)	List Price (Each)
FDC2.50-OSY-DCDA-UL	2 1/2"	1	196	\$7,252
FDC3.00-OSY-DCDA-UL	3"	1	211	\$7,786
FDC4.00-OSY-DCDA-UL	4"	1	240	\$7,998
FDC6.00-OSY-DCDA-UL	6"	1	382	\$11,039
FDC8.00-OSY-DCDA-UL	8"	1	970	\$25,497
FDC10.00-OSY-DCDA-UL	10"	1	1290	\$30,296

OSY RESILIENT SEATED SHUTOFF VALVES, GROOVED CONNECTIONS

Model Number	Size	Qty. per Carton	Weight per Carton (Lbs.)	List Price (Each)
FDC2.50-OSYG-DCDA-UL	2 1/2"	1	187	\$7,252
FDC3.00-OSYG-DCDA-UL	3"	1	200	\$7,786
FDC4.00-OSYG-DCDA-UL	4"	1	228	\$7,998
FDC6.00-OSYG-DCDA-UL	6"	1	363	\$11,039
FDC8.00-OSYG-DCDA-UL	8"	1	950	\$25,497
FDC10.0-OSYG-DCDA-UL	10"	1	1260	\$30,296

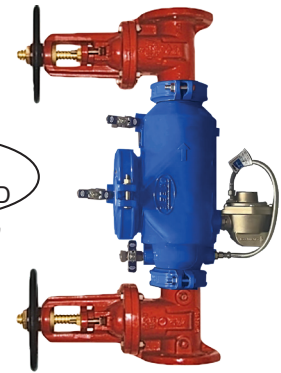

USC
APPROVED
2 1/2" - 10"



APPROVALS:

Tested and certified to ASSE Standard 1015-2011 and CSA B64.0 and listed with IAPMO



FDC3.00-OSY-DCDA (ILLUSTRATED)

FOR SPEC. SHEETS GO TO www.beecobackflow.com

BEECO® Double Detector Check Assemblies prevent the backflow of contaminated materials back into the potable water supply. The DCDA valve incorporates a meter to detect and measure ground leaks and illegal taps, reducing water expenses.

Its modern, light-weight design is made of ductile iron and fused bonded epoxy coating. The shutoff devices are AWWA 509 compliant.



(2 1/2" - 4" SIZES ONLY)

APPROVALS:

Tested and certified to ASSE Standard ASSE 1048, AWWA Compliant C510 (with gates only), CSA B64.5 and listed with IAPMO. Valves are tested and listed to UL

"BEECO® is a worry free alternative for all my backflow needs"

- John Marotta, Ridge Plumbing

CALIFORNIA PROPOSITION 65 WARNING. This product contains chemicals known to the State of California to cause cancer and birth defects or other reproductive harm.

Location:



Barracuda 20

DOUBLECHECKBACKFLOW PREVENTERS (DC)



USC
APPROVED

2 1/2" - 8"



WATER QUALITY
ANSI/NSF/CAN 372
(MH63779)

Flanged or grooved gate valve connections

NRS or OS & Y gate valves

Easy to access cover

Short lay length with light weight

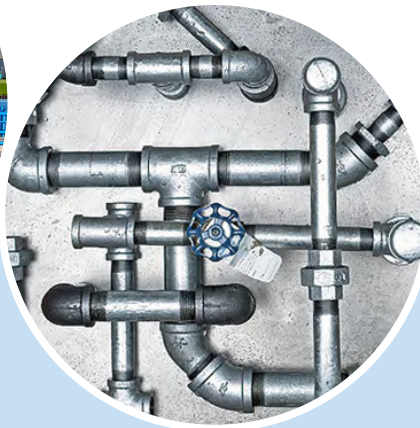

INTRODUCING THE BARRACUDA 20:

- The Shortest
- Lightest
- Most Economical
- Best Performing

SPECIFICALLY DESIGNED FOR:

- Plumbing
- Irrigation
- Waterworks
- Indoor /Outdoor

CALIFORNIA PROPOSITION 65 WARNING. This product contains chemicals known to the State of California to cause cancer and birth defects or other reproductive harm.

Location: _____



Barracuda 20

DOUBLE CHECK BACKFLOW PREVENTERS (DC)



MEASURES AND MATERIALS

CLASSIFIED

 WATER QUALITY

 ANS/NF/CAN 372

 (MH63779)

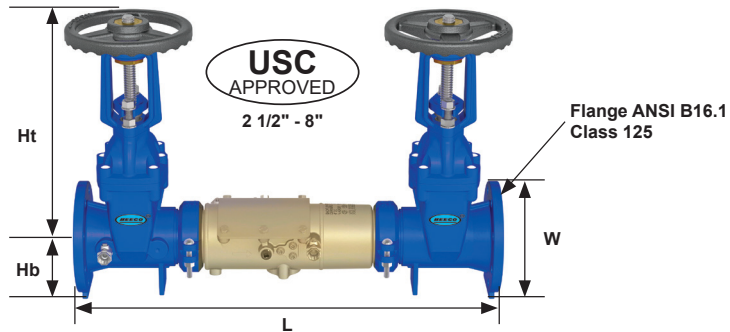

FLOW PERFORMANCE:

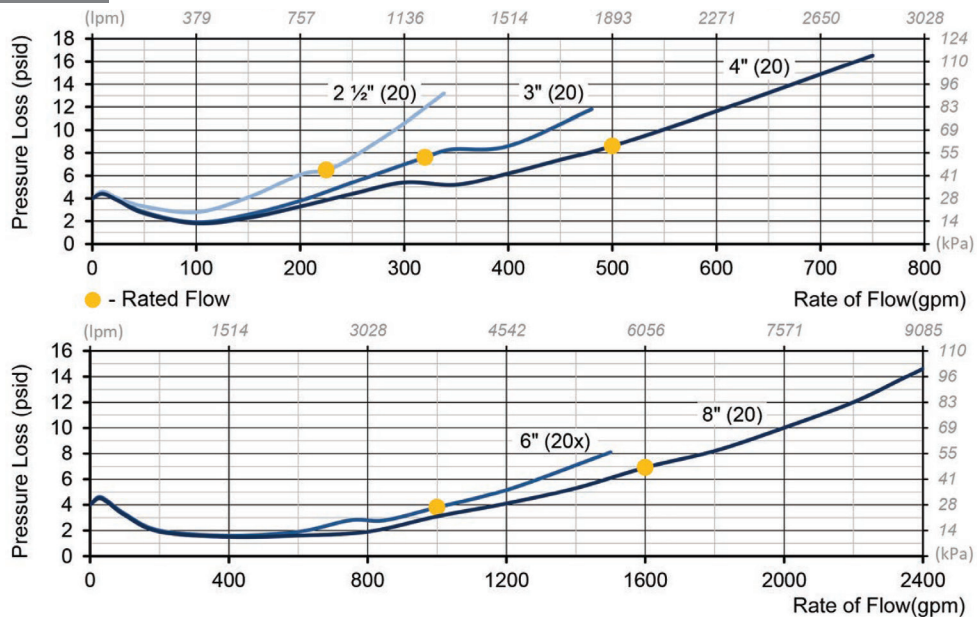

SIZE		MODEL	Ht.		Hb.		Ht. + Hb.		L		FLANGE		W		WEIGHT		DC ASSEMBLY WEIGHT (lbs.)		
IN	MM		IN	MM	IN	MM	IN	MM	IN	MM	IN	MM	IN	MM	Lbs.	Kg.	Model	OS&Y	NRS
2½	65	20	19.00	483	3.6	92	22.6	574	31.9	810	2½	65	11.0	279	122	55	GV2.5	121	101
3	80	20	19.5	495	3.8	97	23.3	592	31.9	810	3	80	11.0	279	126	57	GV3	145	117
4	100	20	22.5	572	4.5	114	27	686	33.9	861	4	100	11.0	279	160	73	GV4	166	150
6	150	20	30.9	785	5.5	140	36.4	925	42.8	1087	6	150	14.1	358	338	153	GV6	328	295
8	200	20	39.4	1001	6.8	173	46.2	1173	44.8	1138	8	200	14.6	371	452	205	GV8	411	401

Valve Housing: 304 Stainless Steel
Valve Cover: 304 Stainless Steel
SOV Disks: EPDM/304SS
SOV Shafts: 304 Stainless Steel

SOV Bearings: Teflon/Bronze
Non Wetted Bolts: Grade 8 Zinc Plated
Wetted Fasteners: 18-8 Stainless Steel
Check Disks: Silicone

Check Springs: 17-7 Stainless Steel
Check Pins: 17-7/18-8 Stainless Steel
Check Seats: Noryl Polymer
O-Rings: Buna-N

CALIFORNIA PROPOSITION 65 WARNING. This product contains chemicals known to the State of California to cause cancer and birth defects or other reproductive harm.

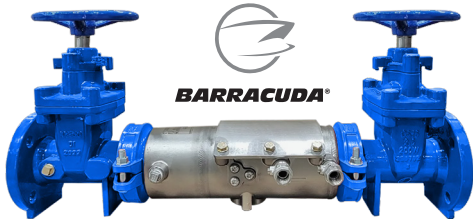

Specification: The BEECO® Series Barracuda 20 Double Check Valve Assembly (DC) is designed to prevent non-health hazard pollutants from entering the potable water supply system caused by backpressure and/or backsiphonage conditions.

Sizes:
2 1/2" thru 8"

Working Pressure:
10-175 PSI

Lead Free:
0.25% Maximum by Weight

- Valve Housing:** 304 Stainless Steel
- Valve Cover:** 304 Stainless Steel
- SOV Disks:** EPDM/304SS
- SOV Shafts:** 304 Stainless Steel
- SOV Bearings:** Teflon/Bronze
- Non Wetted Bolts:** Grade 8 Zinc Plated
- Wetted Fasteners:** 18-8 Stainless Steel
- Check Disks:** Silicone
- Check Springs:** 17-7 Stainless Steel
- Check Pins:** 17-7/18-8 Stainless Steel
- Check Seats:** Noryl Polymer
- O-Rings:** Buna-N



BARRACUDA 20 FDC - LARGE - (2 1/2" - 8") BARRACUDA DOUBLE CHECK, STAINLESS STEEL BACKFLOW PREVENTERS

STAINLESS STEEL BODY AND NRS GATE VALVES FLANGED CONNECTIONS

Model Number	Size	Qty. per Carton	Weight per Carton (Lbs.)	List Price (Each)
FDC2.50-SS-NRS	2/1/2"	1	101	\$4,187
FDC3.00-SS-NRS	3"	1	117	\$4,347
FDC4.00-SS-NRS	4"	1	150	\$4,948
FDC6.00-SSX-NRS	6"	1	295	\$7,669
FDC8.00-SS-NRS	8"	1	401	\$21,177

STAINLESS STEEL BODY AND NRS GATE VALVES WITH GROOVED ENDS

Model Number	Size	Qty. per Carton	Weight per Carton (Lbs.)	List Price (Each)
FDC2.50-SS-NRS-G	2/1/2"	1	96	\$4,187
FDC3.00-SS-NRS-G	3"	1	111	\$4,347
FDC4.00-SS-NRS-G	4"	1	140	\$4,948
FDC6.00-SSX-NRS-G	6"	1	280	\$7,669
FDC8.00-SS-NRS-G	8"	1	381	\$21,177

STAINLESS STEEL BODY AND NRS GATE VALVES FLANGED CONNECTIONS STRAINER ATTACHED

Model Number	Size	Qty. per Carton	Weight per Carton (Lbs.)	List Price (Each)
FDC2.50-SS-NRS-S	2/1/2"	1	136	\$4,605
FDC3.00-SS-NRS-S	3"	1	155	\$4,911
FDC4.00-SS-NRS-S	4"	1	210	\$5,616
FDC6.00-SSX-NRS-S	6"	1	425	\$9,173
FDC8.00-SS-NRS-S	8"	1	676	\$23,435

"My favorite thing about MIFAB is the great people. They are wonderful starting with the owner, the Sales Managers and right on down the line."

- Dan Thomas of Ben Thomas and Associates, Shade Gap, PA

CALIFORNIA PROPOSITION 65 WARNING. This product contains chemicals known to the State of California to cause cancer and birth defects or other reproductive harm.

BARRACUDA 20 FDC - LARGE - (2 1/2" - 8") BARRACUDA DOUBLE CHECK, STAINLESS STEEL BACKFLOW PREVENTERS



STAINLESS STEEL BODY AND OSY GATE VALVES FLANGED CONNECTIONS				
Model Number	Size	Qty. per Carton	Weight per Carton (Lbs.)	List Price (Each)
FDC2.50-SS-OSY	2 1/2"	1	121	\$4,490
FDC3.00-SS-OSY	3"	1	145	\$4,547
FDC4.00-SS-OSY	4"	1	166	\$5,148
FDC6.00-SSX-OSY	6"	1	328	\$7,794
FDC8.00-SS-OSY	8"	1	411	\$22,308

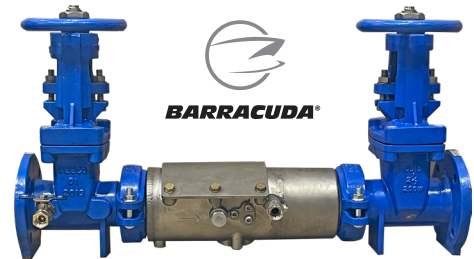

Specification: The BEECO® Series Barracuda 20 Double Check Valve Assembly (DC) is designed to prevent non-health hazard pollutants from entering the potable water supply system caused by backpressure and/or backsiphonage conditions

STAINLESS STEEL BODY AND OSY GATE VALVES WITH GROOVED ENDS				
Model Number	Size	Qty. per Carton	Weight per Carton (Lbs.)	List Price (Each)
FDC2.50-SS-OSY-G	2 1/2"	1	116	\$4,490
FDC3.00-SS-OSY-G	3"	1	139	\$4,547
FDC4.00-SS-OSY-G	4"	1	156	\$5,148
FDC6.00-SSX-OSY-G	6"	1	313	\$7,794
FDC8.00-SS-OSY-G	8"	1	391	\$22,308

Sizes:
2 1/2" thru 8"

Working Pressure:
10-175 PSI

Lead Free:
0.25% Maximum by Weight

STAINLESS STEEL BODY AND OSY GATE VALVES FLANGED CONNECTIONS STRAINER ATTACHED				
Model Number	Size	Qty. per Carton	Weight per Carton (Lbs.)	List Price (Each)
FDC2.50-SS-OSY-S	2 1/2"	1	156	\$4,907
FDC3.00-SS-OSY-S	3"	1	183	\$5,108
FDC4.00-SS-OSY-S	4"	1	226	\$5,813
FDC6.00-SSX-OSY-S	6"	1	458	\$9,295
FDC8.00-SS-OSY-S	8"	1	686	\$24,555

- Valve Housing:** 304 Stainless Steel
- Valve Cover:** 304 Stainless Steel
- SOV Disks:** EPDM/304SS
- SOV Shafts:** 304 Stainless Steel
- SOV Bearings:** Teflon/Bronze
- Non Wetted Bolts:** Grade 8 Zinc Plated
- Wetted Fasteners:** 18-8 Stainless Steel
- Check Disks:** Silicone
- Check Springs:** 17-7 Stainless Steel
- Check Pins:** 17-7/18-8 Stainless Steel
- Check Seats:** Noryl Polymer
- O-Rings:** Buna-N



WATER QUALITY
ANSI/NSF/CAN 372
(MH63779)

CALIFORNIA PROPOSITION 65 WARNING. This product contains chemicals known to the State of California to cause cancer and birth defects or other reproductive harm.

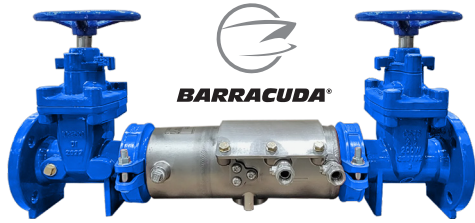

Specification: The BEECO® Series Barracuda 20 Double Check Valve Assembly (DC) is designed to prevent non-health hazard pollutants from entering the potable water supply system caused by backpressure and/or backsiphonage conditions

Sizes:
2½", 3", 4", 6"(x), 8"

Working Pressure:
10-175psi (0.7-12.1 bar)

Temperature Range:
33°-140°F (1°-60°C) ANSI B16.1

Flanged Ends:
Class 125

Lead Free:
0.25% Maximum by Weight

- Valve Housing:** 304 Stainless Steel
- Valve Cover:** 304 Stainless Steel
- SOV Disks:** EPDM/304SS
- SOV Shafts:** 304 Stainless Steel
- SOV Bearings:** Teflon/Bronze
- Non Wetted Bolts:** Grade 8 Zinc Plated
- Wetted Fasteners:** 18-8 Stainless Steel
- Check Disks:** Silicone
- Check Springs:** 17-7 Stainless Steel
- Check Pins:** 17-7/18-8 Stainless Steel
- Check Seats:** Noryl Polymer
- O-Rings:** Buna-N



WATER QUALITY
ANSI/NSF/CAN 372
(MH63779)

**FDC (LARGE 2 1/2" - 8")
DOUBLE CHECK BACKFLOW PREVENTERS
MEET BUY AMERICA AND PSA STANDARDS WITH
SUFFIX -BA / -PSA SELECTED**

STAINLESS STEEL BODY AND NRS GATE VALVES FLANGED CONNECTIONS

Model Number	Size	Qty. per Carton	Weight per Carton (Lbs.)	List Price (Each)
FDC2.50-SS-NRS-BA	2/1/2"	1	101	\$4,971
FDC3.00-SS-NRS-BA	3"	1	117	\$5,131
FDC4.00-SS-NRS-BA	4"	1	150	\$5,732
FDC6.00-SSX-NRS-BA	6"	1	295	\$8,453
FDC8.00-SS-NRS-BA	8"	1	401	\$21,961

NOTE: Replace suffix -BA with suffix -PSA for Pennsylvania Steel Act compliant backflow preventers.

STAINLESS STEEL BODY AND NRS GATE VALVES WITH GROOVED ENDS

Model Number	Size	Qty. per Carton	Weight per Carton (Lbs.)	List Price (Each)
FDC2.50-SS-NRS-G-BA	2/1/2"	1	96	\$4,971
FDC3.00-SS-NRS-G-BA	3"	1	111	\$5,131
FDC4.00-SS-NRS-G-BA	4"	1	140	\$5,732
FDC6.00-SSX-NRS-G-BA	6"	1	280	\$8,453
FDC8.00-SS-NRS-G-BA	8"	1	381	\$21,961

NOTE: Replace suffix -BA with suffix -PSA for Pennsylvania Steel Act compliant backflow preventers.

STAINLESS STEEL BODY AND NRS GATE VALVES FLANGED CONNECTIONS STRAINER ATTACHED

Model Number	Size	Qty. per Carton	Weight per Carton (Lbs.)	List Price (Each)
FDC2.50-SS-NRS-S-BA	2/1/2"	1	136	\$5,389
FDC3.00-SS-NRS-S-BA	3"	1	155	\$5,695
FDC4.00-SS-NRS-S-BA	4"	1	210	\$6,400
FDC6.00-SSX-NRS-S-BA	6"	1	425	\$9,957
FDC8.00-SS-NRS-S-BA	8"	1	676	\$24,219

NOTE: Replace suffix -BA with suffix -PSA for Pennsylvania Steel Act compliant backflow preventers.

CALIFORNIA PROPOSITION 65 WARNING. This product contains chemicals known to the State of California to cause cancer and birth defects or other reproductive harm.

**FDC (LARGE 2 1/2" - 8")
DOUBLE CHECK BACKFLOW PREVENTERS
MEET BUY AMERICA AND PSA STANDARDS WITH
SUFFIX -BA / -PSA SELECTED**

STAINLESS STEEL BODY AND OSY GATE VALVES FLANGED CONNECTIONS

Model Number	Size	Qty. per Carton	Weight per Carton (Lbs.)	List Price (Each)
FDC2.50-SS-OSY-BA	2/1/2"	1	121	\$5,274
FDC3.00-SS-OSY-BA	3"	1	145	\$5,331
FDC4.00-SS-OSY-BA	4"	1	166	\$5,932
FDC6.00-SSX-OSY-BA	6"	1	328	\$8,578
FDC8.00-SS-OSY-BA	8"	1	411	\$23,092

NOTE: Replace suffix -BA with suffix -PSA for Pennsylvania Steel Act compliant backflow preventers.

STAINLESS STEEL BODY AND OSY GATE VALVES WITH GROOVED ENDS

Model Number	Size	Qty. per Carton	Weight per Carton (Lbs.)	List Price (Each)
FDC2.50-SS-OSY-G-BA	2/1/2"	1	116	\$5,274
FDC3.00-SS-OSY-G-BA	3"	1	139	\$5,331
FDC4.00-SS-OSY-G-BA	4"	1	156	\$5,932
FDC6.00-SSX-OSY-G-BA	6"	1	313	\$8,578
FDC8.00-SS-OSY-G-BA	8"	1	391	\$23,092

NOTE: Replace suffix -BA with suffix -PSA for Pennsylvania Steel Act compliant backflow preventers.

STAINLESS STEEL BODY AND OSY GATE VALVES FLANGED CONNECTIONS STRAINER ATTACHED

Model Number	Size	Qty. per Carton	Weight per Carton (Lbs.)	List Price (Each)
FDC2.50-SS-OSY-S-BA	2/1/2"	1	156	\$5,691
FDC3.00-SS-OSY-S-BA	3"	1	183	\$5,892
FDC4.00-SS-OSY-S-BA	4"	1	226	\$6,597
FDC6.00-SSX-OSY-S-BA	6"	1	458	\$10,079
FDC8.00-SS-OSY-S-BA	8"	1	686	\$25,339

NOTE: Replace suffix -BA with suffix -PSA for Pennsylvania Steel Act compliant backflow preventers.

"I feel comfortable calling MIFAB to ask for advice and assistance." - Joe Ficek of Grumman Butkus, Consulting Engineers, Chicago, IL

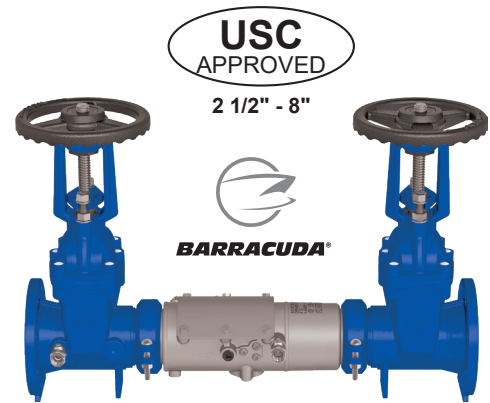

Specification: The BEECO® Series Barracuda 20 Double Check Valve Assembly (DC) is designed to prevent non-health hazard pollutants from entering the potable water supply system caused by backpressure and/or backsiphonage conditions

Sizes:
2 1/2", 3", 4", 6"(x), 8"

Working Pressure:
10-175psi (0.7-12.1 bar)

Temperature Range:
33°-140°F (1°-60°C) ANSI B16.1

Flanged Ends:
Class 125

Lead Free:
0.25% Maximum by Weight

Valve Housing: 304 Stainless Steel

Valve Cover: 304 Stainless Steel

SOV Disks: EPDM/304SS

SOV Shafts: 304 Stainless Steel

SOV Bearings: Teflon/Bronze

Non Wetted Bolts: Grade 8 Zinc Plated

Wetted Fasteners: 18-8 Stainless Steel

Check Disks: Silicone

Check Springs: 17-7 Stainless Steel

Check Pins: 17-7/18-8 Stainless Steel

Check Seats: Noryl Polymer

O-Rings: Buna-N



**WATER QUALITY
ANSI/NSF/CAN 372
(MH63779)**



CALIFORNIA PROPOSITION 65 WARNING. This product contains chemicals known to the State of California to cause cancer and birth defects or other reproductive harm.

BEECO® REDUCED PRESSURE ZONE BACKFLOW PREVENTERS

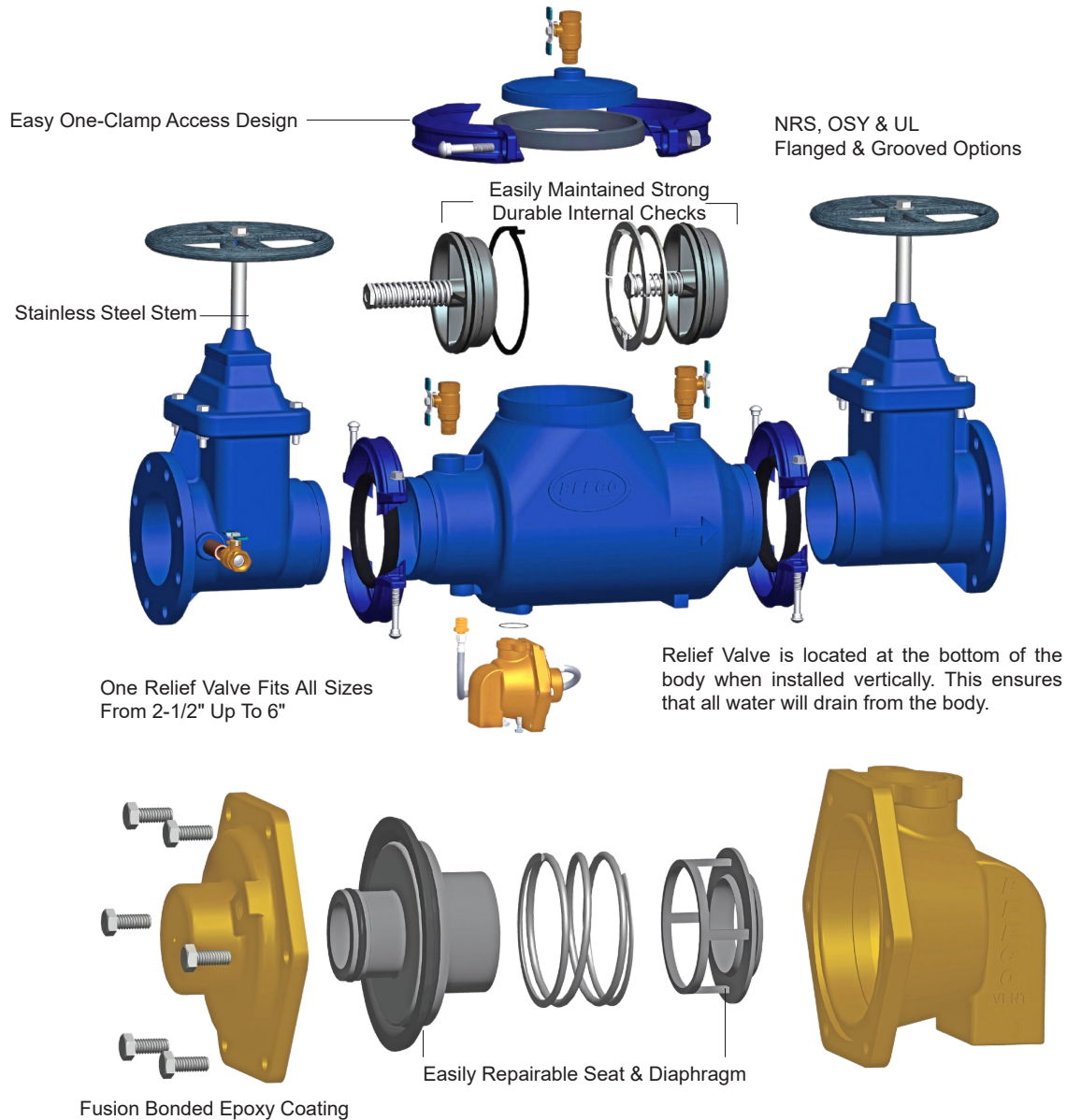

FEATURES AND BENEFITS:

The new redesigned BEECO® Reduced Pressure Zone Device was designed with input from hundreds of plumbers, and many backflow specialists were involved. It was designed with ease of access and a dramatic reduction in the number of spare parts needed. The light weight short lay length modular design makes this valve the easiest and quickest valve to perform your mandatory yearly certification on. For a complete list of all our features and benefits, see our website: www.beecobackflow.com. The BEECO® Pressure Reduced Zone Device comes with a detector check bypass and flow meter used on fire lines. See the RPDA product offering.

"MIFAB has always been a very high quality product that has been backed by high quality Customer Service." - Plumbing Wholesaler, Phoenix, Arizona

CALIFORNIA PROPOSITION 65 WARNING. This product contains chemicals known to the State of California to cause cancer and birth defects or other reproductive harm.

FRP (SMALL 1/2" - 2") REDUCED PRESSURE ZONE BACKFLOW PREVENTERS

WITH 1/4 TURN SHUTOFF VALVES

Model Number	Size	Qty. per Carton	Weight per Carton (Lbs.)	List Price (Each)
FRP.50-QT-LL	1/2"	1	6	\$426
FRP.75-QT-LL	3/4"	1	6	\$452
FRP1.00-QT-LL	1"	1	9	\$647
FRP1.25-QT-LL	1 1/4"	1	13	\$1,677
FRP1.50-QT-LL	1 1/2"	1	17	\$1,819
FRP2.00-QT-LL	2"	1	26	\$2,091

WITH 1/4 TURN SHUTOFF VALVES AND LOCKING HANDLES

Model Number	Size	Qty. per Carton	Weight per Carton (Lbs.)	List Price (Each)
FRP.50-QT-LH-LL	1/2"	1	6	\$468
FRP.75-QT-LH-LL	3/4"	1	6	\$497
FRP1.00-QT-LH-LL	1"	1	9	\$712
FRP1.25-QT-LH-LL	1 1/4"	1	13	\$1,845
FRP1.50-QT-LH-LL	1 1/2"	1	17	\$2,000
FRP2.00-QT-LH-LL	2"	1	26	\$2,300

WITH 1/4 TURN SHUTOFF VALVES AND STAINLESS STEEL HANDLES

Model Number	Size	Qty. per Carton	Weight per Carton (Lbs.)	List Price (Each)
FRP.50-QT-SH-LL	1/2"	1	6	\$468
FRP.75-QT-SH-LL	3/4"	1	6	\$497
FRP1.00-QT-SH-LL	1"	1	9	\$712
FRP1.25-QT-SH-LL	1 1/4"	1	13	\$1,845
FRP1.50-QT-SH-LL	1 1/2"	1	17	\$2,000
FRP2.00-QT-SH-LL	2"	1	26	\$2,300

WITH 1/4 TURN SHUTOFF VALVES AND WYE TYPE STRAINER

Model Number	Size	Qty. per Carton	Weight per Carton (Lbs.)	List Price (Each)
FRP.50-QT-S-LL	1/2"	1	7	\$455
FRP.75-QT-S-LL	3/4"	1	7	\$500
FRP1.00-QT-S-LL	1"	1	10	\$721
FRP1.25-QT-S-LL	1 1/4"	1	15	\$1,786
FRP1.50-QT-S-LL	1 1/2"	1	19	\$1,975
FRP2.00-QT-S-LL	2"	1	31	\$2,343

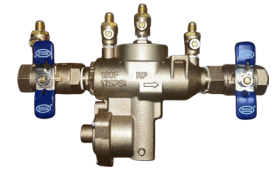

FRP.75-QT-LL (ILLUSTRATED)

FOR SPEC. SHEETS GO TO
www.beecobackflow.com

SPECIFICATION: The BEECO® Friendly Reduced Pressure Zone Backflow Preventer is designed to stop the reverse of flow of a liquid into a potable water system. The proper installation of a backflow preventer must be done by a certified expert under local codes and guidelines to assure the protection of the drinking water system. The Valve is certified to ASSE 1013, CSA B64.4 and listed with IAPMO.

FUNCTION: The assembly shall consist of two repairable positive seating check modules with captured springs and rubber seat discs. Service of all internal check components shall be through a single screwed in cover and designed for ease of access. The valve shall be equipped with a serviceable and replaceable relief valve with easy access repair and replacement while in line.

FEATURES: The checks are designed with a unique thumb screw holding in the disc to allow for easy removal of the check with a simple pair of pliers dramatically reducing part breakage during repair. The single threaded cover makes for the quickest access inside the valve in the industry. Repair parts are so modular it only takes two relief valve kits and three check repair kits to cover all sizes 1/2" through 2".

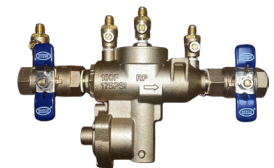

FRP2.00-QT-LL (ILLUSTRATED)

FOR SPEC. SHEETS GO TO
www.beecobackflow.com



APPROVALS:

Tested and certified to ASSE 1013-2021 and CSA B64.4-2011 (R2016) and listed with IAPMO

CALIFORNIA PROPOSITION 65 WARNING. This product contains chemicals known to the State of California to cause cancer and birth defects or other reproductive harm.



Distributed by: MIFAB

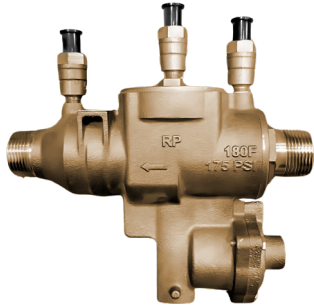

FRP1.00-LF-LL (ILLUSTRATED)
FOR SPEC. SHEETS GO TO
www.beecobackflow.com

**FRP (SMALL 1/2" - 2")
REDUCED PRESSURE ZONE BACKFLOW PREVENTERS**

LESS SHUTOFFS				
Model Number	Size	Qty. per Carton	Weight per Carton (Lbs.)	List Price (Each)
FRP.50-LF-LL	1/2"	1	5	\$325
FRP.75-LF-LL	3/4"	1	5	\$345
FRP1.00-LF-LL	1"	1	7	\$495
FRP1.25-LF-LL	1 1/4"	1	10	\$1,281
FRP1.50-LF-LL	1 1/2"	1	13	\$1,389
FRP2.00-LF-LL	2"	1	20	\$1,597

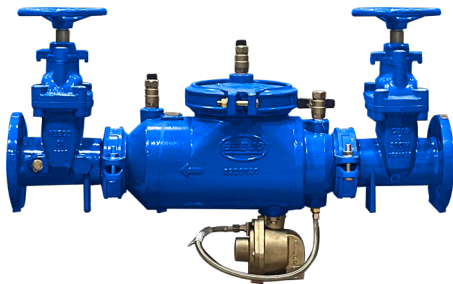

FRP3.00-NRS (ILLUSTRATED)
FOR SPEC. SHEETS GO TO
www.beecobackflow.com

**FRP (LARGE 2 1/2" - 10")
REDUCED PRESSURE ZONE BACKFLOW PREVENTERS**

WITH FLANGED CONNECTIONS, DUCTILE IRON SHUTOFF DEVICES NRS RESILIENT SEATED SHUTOFF VALVES				
Model Number	Size	Qty. per Carton	Weight per Carton (Lbs.)	List Price (Each)
FRP2.50-NRS	2 1/2"	1	193	\$4,903
FRP3.00-NRS	3"	1	210	\$5,072
FRP4.00-NRS	4"	1	232	\$5,701
FRP6.00-NRS	6"	1	390	\$8,439
FRP8.00-NRS	8"	1	940	\$23,249
FRP10.00-NRS	10"	1	1210	\$27,577

All BEECO® FRP valves 2 1/2" thru 4" can be installed in the vertical position.

BEECO® Reduced Pressure Backflow Prevention Devices are designed to protect against contamination of potable water. Installation and selection of the proper device should be made by a qualified licensed professional.



APPROVALS:

Tested and certified to ASSE 1013-2021 and CSA B64.4-2011 (R2016) and listed with IAPMO

"Mifab's line of BEECO® backflow devices equals quality at an affordable price"

- Jeff Cisar, Prochazka Plumbing

CALIFORNIA PROPOSITION 65 WARNING. This product contains chemicals known to the State of California to cause cancer and birth defects or other reproductive harm.

FRP (LARGE 2 1/2" - 10") REDUCED PRESSURE ZONE BACKFLOW PREVENTERS

OSY RESILIENT SEATED SHUTOFF VALVES, FLANGED CONNECTIONS COMPLIES WITH AND IS LISTED TO UL

Model Number	Size	Qty. per Carton	Weight per Carton (Lbs.)	List Price (Each)
FRP2.50-OSY-UL	2 1/2"	1	201	\$5,127
FRP3.00-OSY-UL	3"	1	216	\$5,388
FRP4.00-OSY-UL	4"	1	247	\$6,075
FRP6.00-OSY-UL	6"	1	396	\$8,801
FRP8.00-OSY-UL	8"	1	990	\$25,099
FRP10.00-OSY-UL	10"	1	1310	\$29,556

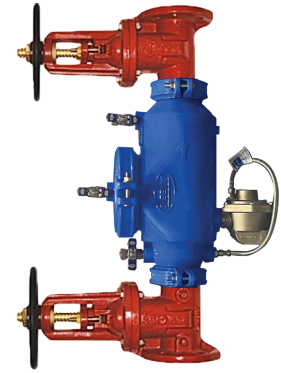

FRP4.00-OSY-UL (ILLUSTRATED)

FOR SPEC. SHEETS GO TO
www.beecobackflow.com

RATINGS:

Maximum working water pressure 175 PSI, Maximum working temperature 140° F, Hydrostatic test pressure 350 PSI, Flanged end connection meet ANSI B16.1 and all grooved dimensions comply with AWWA C606.

Complies with AWWA-C511. All RP devices must be install where a drain is available to cover the discharge in the event there is a backflow condition and the relief valve discharges.

DISCHARGE RATES ARE AS FOLLOWS:

1/2" to 1" 5 GPM,
1 1/4" to 2" 20 GPM,
2 1/2" to 6" 40 GPM, and
8" to 10" 60 GPM.

NRS RESILIENT SEATED SHUTOFF VALVES, WITH A FLANGED STRAINER

Model Number	Size	Qty. per Carton	Weight per Carton (Lbs.)	List Price (Each)
FRP2.50-NRS-S	2 1/2"	1	237	\$5,552
FRP3.00-NRS-S	3"	1	259	\$5,880
FRP4.00-NRS-S	4"	1	315	\$6,651
FRP6.00-NRS-S	6"	1	556	\$10,404
FRP8.00-NRS-S	8"	1	1215	\$26,677
FRP10.00-NRS-S	10"	1	1620	\$32,801

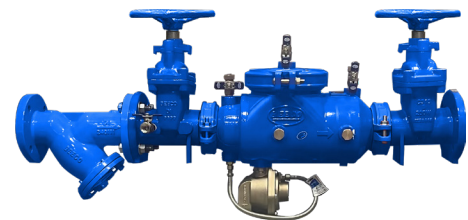

FRP2.50-NRS-S (ILLUSTRATED)

FOR SPEC. SHEETS GO TO
www.beecobackflow.com

SUFFIX	OPTIONAL VARIATIONS
-BA	Minimum 51% material cost made in the USA
-RPDA	Reduced Pressure Zone Detector Assembly
-G	Grooved Flange Connection
-LF	No Gate Valves
-NRS	Non Rising Stem Gate Valve
-OSY	Outside Stem and Yoke Gate Valve
-S	Strainer Attached
-UL	UL tested and approved



APPROVALS:

Tested and certified to ASSE 1013-2021 and CSA B64.4-2011 (R2016) and listed with IAPMO

CALIFORNIA PROPOSITION 65 WARNING. This product contains chemicals known to the State of California to cause cancer and birth defects or other reproductive harm.



FRP4.00-OSY-G (ILLUSTRATED)
FOR SPEC. SHEETS GO TO
www.beecobackflow.com

BEECO® Reduced Pressure Backflow Prevention Devices are designed to protect against contamination of potable water. Installation and selection of the proper device should be made by a qualified licensed professional.



APPROVALS:

Tested and certified to ASSE 1013-2021 and CSA B64.4-2011 (R2016) and listed with IAPMO

**FRP (LARGE 2 1/2" - 10")
REDUCED PRESSURE ZONE BACKFLOW PREVENTERS**

OSY RESILIENT SEATED SHUTOFF VALVES WITH GROOVED CONNECTIONS

Model Number	Size	Qty. per Carton	Weight per Carton (Lbs.)	List Price (Each)
FRP2.50-OSY-G-UL	2 1/2"	1	191	\$4,977
FRP3.00-OSY-G-UL	3"	1	205	\$5,230
FRP4.00-OSY-G-UL	4"	1	235	\$5,899
FRP6.00-OSY-G-UL	6"	1	376	\$8,543
FRP8.00-OSY-G-UL	8"	1	970	\$24,368
FRP10.00-OSY-G-UL	10"	1	1280	\$28,696



FRP4.00-LF (ILLUSTRATED)
FOR SPEC. SHEETS GO TO
www.beecobackflow.com

LESS SHUT OFF DEVICES, GROOVED CONNECTIONS

Model Number	Size	Qty. per Carton	Weight per Carton (Lbs.)	List Price (Each)
FRP2.50-LF	2 1/2"	1	82	\$5,055
FRP3.00-LF	3"	1	82	\$5,055
FRP4.00-LF	4"	1	82	\$5,055
FRP6.00-LF	6"	1	150	\$8,411
FRP8.00-LF	8"	1	300	\$11,902
FRP10.00-LF	10"	1	300	\$15,924

All FDC and FRP devices 2 1/2" thru 10" are available to meet the BUY AMERICA ACT and the PENNSYLVANIA STEEL ACT call customer service for pricing and lead times.

"Performing maintenance on BEECO® backflows is simplistic and fast"

- Joe Hallman, All City Bckflow

CALIFORNIA PROPOSITION 65 WARNING. This product contains chemicals known to the State of California to cause cancer and birth defects or other reproductive harm.

RPDA (2 1/2" - 10") DUCTILE IRON, BACKFLOW PREVENTERS WITH DETECTOR

OSY RESILIENT SEATED SHUTOFF VALVES, FLANGED CONNECTIONS COMPLIES WITH AND IS LISTED TO UL

Model Number	Size	Qty. per Carton	Weight per Carton (Lbs.)	List Price (Each)
FRP2.50-OSY-RPDA-UL	2 1/2"	1	211	\$6,671
FRP3.00-OSY-RPDA-UL	3"	1	225	\$6,924
FRP4.00-OSY-RPDA-UL	4"	1	255	\$7,592
FRP6.00-OSY-RPDA-UL	6"	1	396	\$10,237
FRP8.00-OSY-RPDA-UL	8"	1	990	\$27,190
FRP10.00-OSY-RPDA-UL	10"	1	1300	\$31,518

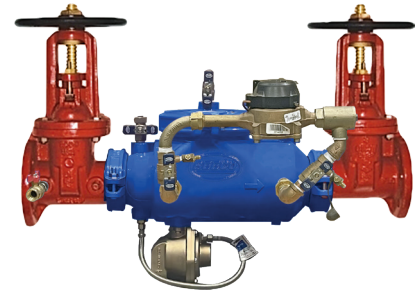

FRP3.00-OSY-RPDA (ILLUSTRATED)
FOR SPEC. SHEETS GO TO
www.beecobackflow.com



(2 1/2" - 4" Sizes only)

APPROVALS:

Tested and certified to ASSE Standard ASSE 1047, AWWA Compliant C510 (with gates only), CSA B64.4 and listed with IAPMO. Valves are tested and listed to UL

"we have installed many of the 4" RPZ in our hotel and we value the quality of the product and the ease of installation"

- Sal, Pipeline Services

OSY RESILIENT SEATED SHUTOFF VALVES, GROOVED CONNECTIONS COMPLIES AND IS LISTED WITH UL

Model Number	Size	Qty. per Carton	Weight per Carton (Lbs.)	List Price (Each)
FRP2.50-OSYG-RPDA-UL	2 1/2"	1	200	\$6,671
FRP3.00-OSYG-RPDA-UL	3"	1	214	\$6,924
FRP4.00-OSYG-RPDA-UL	4"	1	242	\$7,592
FRP6.00-OSYG-RPDA-UL	6"	1	376	\$10,237
FRP8.00-OSYG-RPDA-UL	8"	1	941	\$27,190
FRP10.0-OSYG-RPDA-UL	10"	1	1235	\$31,518

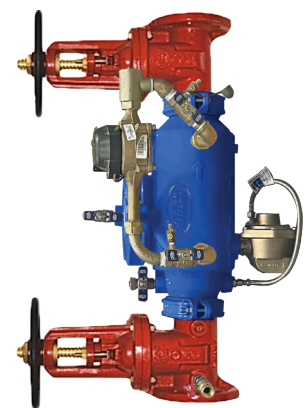

FRP4.00-RPDA-BA (ILLUSTRATED)
FOR SPEC. SHEETS GO TO
www.beecobackflow.com

CALIFORNIA PROPOSITION 65 WARNING. This product contains chemicals known to the State of California to cause cancer and birth defects or other reproductive harm.



Distributed by: MIFAB

BEECO-2026

Location:



Barracuda 40

REDUCED PRESSURE VALVE PREVENTERS (RPZ)



USC
APPROVED

2 1/2" - 8"

CLASSIFIED
UL
C US
WATER QUALITY
ANSI/NSF/CAN 372
(MH63779)

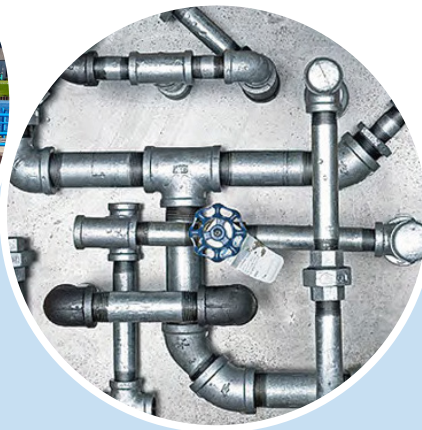

INTRODUCING THE BARRACUDA 40:

- The Shortest
- Lightest
- Most Economical
- Best Performing

SPECIFICALLY DESIGNED FOR:

- Plumbing
- Irrigation
- Waterworks

CALIFORNIA PROPOSITION 65 WARNING. This product contains chemicals known to the State of California to cause cancer and birth defects or other reproductive harm.

Location: _____



Barracuda 40

REDUCED PRESSURE VALVE PREVENTERS (RPZ)



MEASURES AND MATERIALS



WATER QUALITY
ANSI/NSF/CAN 372
(MH63779)

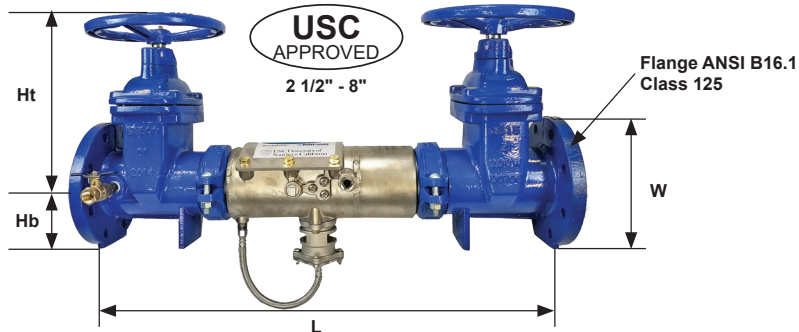

FLOW PERFORMANCE:

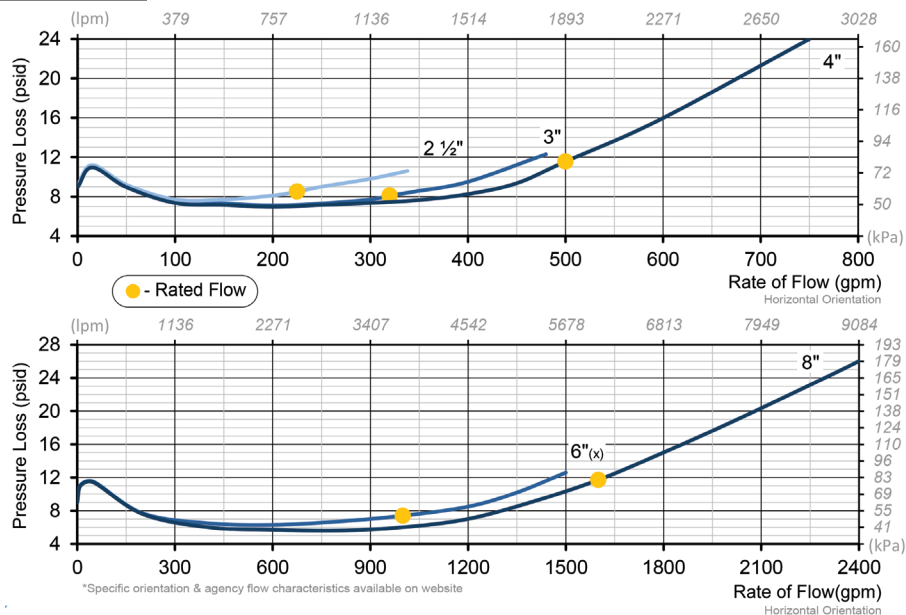

SIZE		MODEL	Ht.		Hb.		Ht. + Hb.		L		FLANGE		W		WEIGHT		RP ASSEMBLY WEIGHT (lbs.)		
IN	MM		IN	MM	IN	MM	IN	MM	IN	MM	IN	MM	IN	MM	Lbs.	Kg.	Model	OS&Y	NRS
2½	65	40	12.5	318	9.9	251	22.4	569	31.9	810	2½	65	11.0	279	106	48	GV2.5	124	104
3	80	40	13.5	343	10.1	257	23.6	599	31.9	810	3	80	11.0	279	110	50	GV3	148	120
4	100	40	14.0	356	10.8	274	24.8	630	33.9	861	4	100	11.0	279	152	69	GV4	169	153
6	150	40	18.1	460	11.8	300	29.9	759	44.8	1138	6	150	14.1	358	294	133	GV6	331	298
8	200	40	22.0	559	13.1	333	35.1	892	44.8	1138	8	200	14.6	371	420	191	GV8	414	404

Valve Housing: 304 Stainless Steel

Valve Cover: 304 Stainless Steel

SOV Disks: EPDM/304SS

SOV Shafts: 304 Stainless Steel

RV Spring: 302 Stainless Steel

SOV Bearings: Teflon/Bronze

Non Wetted Bolts: Grade 8 Zinc Plated

Wetted Fasteners: 18-8 Stainless Steel

All Check Disks: Silicone

RV Housing: 302 Stainless Steel

Check Springs: 17-7 Stainless Steel

Check Pins: 17-7/18-8 Stainless Steel

Check Seats: Noryl Polymer

O-Rings: Buna-N

RV Hose: Braided Stainless Steel Wire

CALIFORNIA PROPOSITION 65 WARNING. This product contains chemicals known to the State of California to cause cancer and birth defects or other reproductive harm.

USC
APPROVED
2 1/2" - 8"

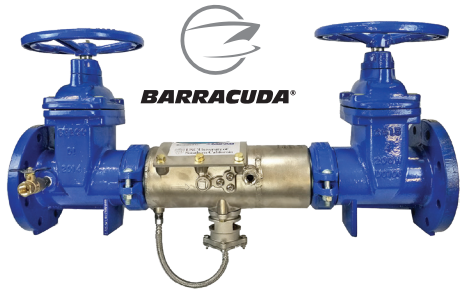

Function: The BEECO® Series Barracuda 40 REDUCED PRESSURE VALVE Backflow Prevention Valve prevents non-health hazard pollutants and hazardous contaminants from entering a potable water supply system when backpressure and/or backsiphonage conditions occur. This product is designed for the waterwork, plumbing, and irrigation markets only.

Sizes: 2½", 3", 4", 6"(x), 8"

Working Pressure:
10-175psi (0.7-12.1 bar)

Temperature Range:
33°-140°F (1°-60°C)

Flanged Ends:
ANSI B16.1 Class 125

Lead Free:
0.25% Maximum by Weight

BARRACUDA 40 FRP - BARRACUDA REDUCED PRESSURE ZONE, STAINLESS STEEL BACKFLOW PREVENTERS

STAINLESS STEEL BODY AND NRS GATE VALVES FLANGED CONNECTIONS

Model Number	Size	Qty. per Carton	Weight per Carton (Lbs.)	List Price (Each)
FRP2.50-SS-NRS	2/1/2"	1	104	\$4,903
FRP3.00-SS-NRS	3"	1	120	\$5,072
FRP4.00-SS-NRS	4"	1	153	\$5,701
FRP6.00-SSX-NRS	6"	1	298	\$8,439
FRP8.00-SS-NRS	8"	1	404	\$23,249

STAINLESS STEEL BODY AND NRS GATE VALVES GROOVED CONNECTIONS

Model Number	Size	Qty. per Carton	Weight per Carton (Lbs.)	List Price (Each)
FRP2.50-SS-NRS-G	2/1/2"	1	99	\$4,903
FRP3.00-SS-NRS-G	3"	1	114	\$5,072
FRP4.00-SS-NRS-G	4"	1	143	\$5,701
FRP6.00-SSX-NRS-G	6"	1	283	\$8,439
FRP8.00-SS-NRS-G	8"	1	384	\$23,249

STAINLESS STEEL BODY AND NRS GATE VALVES FLANGED CONNECTIONS STRAINER ATTACHED

Model Number	Size	Qty. per Carton	Weight per Carton (Lbs.)	List Price (Each)
FRP2.50-SS-NRS-S	2/1/2"	1	139	\$5,358
FRP3.00-SS-NRS-S	3"	1	158	\$5,753
FRP4.00-SS-NRS-S	4"	1	213	\$6,521
FRP6.00-SSX-NRS-S	6"	1	428	\$10,006
FRP8.00-SS-NRS-S	8"	1	679	\$26,472



CLASSIFIED
UL US
WATER QUALITY
ANSI/NSF/CAN 372
(MH63779)

"We have installed many of the 4" BEECO® RPZ in our hotel projects and we value the quality of the product and the easy installation."

- Sal from Pipeline Services

CALIFORNIA PROPOSITION 65 WARNING. This product contains chemicals known to the State of California to cause cancer and birth defects or other reproductive harm.

BARRACUDA 40 FRP - BARRACUDA REDUCED PRESSURE ZONE, STAINLESS STEEL BACKFLOW PREVENTERS

STAINLESS STEEL BODY AND OSY GATE VALVES FLANGED CONNECTIONS

Model Number	Size	Qty. per Carton	Weight per Carton (Lbs.)	List Price (Each)
FRP2.50-SS-OSY	2 1/2"	1	124	\$4,977
FRP3.00-SS-OSY	3"	1	148	\$5,230
FRP4.00-SS-OSY	4"	1	169	\$5,899
FRP6.00-SSX-OSY	6"	1	331	\$8,543
FRP8.00-SS-OSY	8"	1	414	\$24,368

STAINLESS STEEL BODY AND OSY GATE VALVES GROOVED CONNECTIONS

Model Number	Size	Qty. per Carton	Weight per Carton (Lbs.)	List Price (Each)
FRP2.50-SS-OSY-G	2 1/2"	1	119	\$4,977
FRP3.00-SS-OSY-G	3"	1	142	\$5,230
FRP4.00-SS-OSY-G	4"	1	159	\$5,899
FRP6.00-SSX-OSY-G	6"	1	316	\$8,543
FRP8.00-SS-OSY-G	8"	1	394	\$24,368

STAINLESS STEEL BODY AND OSY GATE VALVES FLANGED CONNECTIONS STRAINER ATTACHED

Model Number	Size	Qty. per Carton	Weight per Carton (Lbs.)	List Price (Each)
FRP2.50-SS-OSY-S	2 1/2"	1	159	\$5,552
FRP3.00-SS-OSY-S	3"	1	186	\$5,880
FRP4.00-SS-OSY-S	4"	1	229	\$6,651
FRP6.00-SSX-OSY-S	6"	1	461	\$10,404
FRP8.00-SS-OSY-S	8"	1	689	\$26,677

USC
APPROVED
2 1/2 - 8"

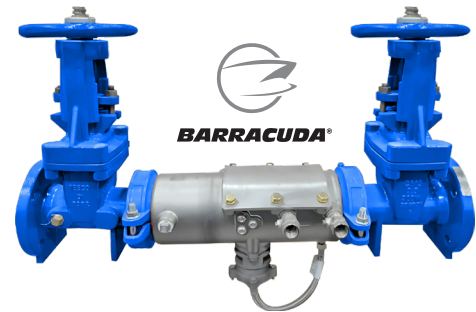

FDC2.50-SS-OSY (ILLUSTRATED)

FOR SPEC. SHEETS GO TO
www.beecobackflow.com

Function: The BEECO® Series Barracuda 40 REDUCED PRESSURE VALVE Backflow Prevention Valve prevents non-health hazard pollutants and hazardous contaminants from entering a potable water supply system when backpressure and/or backsiphonage conditions occur. This product is designed for the waterwork, plumbing, and irrigation markets only.

Sizes: 2 1/2", 3", 4", 6"(x), 8"

Working Pressure:
10-175psi (0.7-12.1 bar)

Temperature Range:
33°-140°F (1°-60°C)

Flanged Ends:
ANSI B16.1 Class 125

Lead Free:
0.25% Maximum by Weight

Valve Housing: 304 Stainless Steel

Valve Cover: 304 Stainless Steel

SOV Disks: EPDM/304SS

SOV Shafts: 304 Stainless Steel

RV Spring: 302 Stainless Steel

SOV Bearings: Teflon/Bronze

Non Wetted Bolts: Grade 8 Zinc Plated

Wetted Fasteners: 18-8 Stainless Steel

All Check Disks: Silicone

RV Housing: 302 Stainless Steel

Check Springs: 17-7 Stainless Steel

Check Pins: 17-7/18-8
Stainless Steel

Check Seats: Noryl Polymer

O-Rings: Buna-N

RV Hose: Braided Stainless Steel Wire



WATER QUALITY
ANSI/NSF/CAN 372
(MH63779)

CALIFORNIA PROPOSITION 65 WARNING. This product contains chemicals known to the State of California to cause cancer and birth defects or other reproductive harm.

USC
APPROVED
2 1/2" - 8"

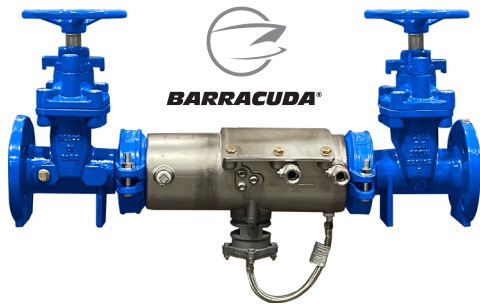

Function: The BEECO® Series Barracuda 40 REDUCED PRESSURE VALVE Backflow Prevention Valve prevents non-health hazard pollutants and hazardous contaminants from entering a potable water supply system when backpressure and/or backsiphonage conditions occur. This product is designed for the waterwork, plumbing, and irrigation markets only.

Sizes: 2½", 3", 4", 6"(x), 8"

Working Pressure:
10-175psi (0.7-12.1 bar)

Temperature Range:
33°-140°F (1°-60°C)

Flanged Ends:
ANSI B16.1 Class 125

Lead Free:
0.25% Maximum by Weight



ANSI/NSF/CAN 372
(MH63779)

Valve Housing: 304 Stainless Steel
Valve Cover: 304 Stainless Steel
SOV Disks: EPDM/304SS
SOV Shafts: 304 Stainless Steel
RV Spring: 302 Stainless Steel
SOV Bearings: Teflon/Bronze
Non Wetted Bolts: Grade 8 Zinc Plated
Wetted Fasteners: 18-8 Stainless Steel
All Check Disks: Silicone
RV Housing: 302 Stainless Steel
Check Springs: 17-7 Stainless Steel
Check Pins: 17-7/18-8 Stainless Steel
Check Seats: Noryl Polymer
O-Rings: Buna-N
RV Hose: Braided Stainless Steel Wire

**BARRACUDA 40 FRP -
REDUCED PRESSURE ZONE STAINLESS STEEL
BACKFLOW PREVENTERS MEET BUY AMERICA AND
PSA STANDARDS WITH SUFFIX -BA / -PSA SELECTED**

STAINLESS STEEL BODY AND NRS GATE VALVES FLANGED CONNECTIONS

Model Number	Size	Qty. per Carton	Weight per Carton (Lbs.)	List Price (Each)
FRP2.50-SS-NRS-BA	2/1/2"	1	104	\$5,687
FRP3.00-SS-NRS-BA	3"	1	120	\$5,856
FRP4.00-SS-NRS-BA	4"	1	153	\$6,485
FRP6.00-SSX-NRS-BA	6"	1	298	\$9,223
FRP8.00-SS-NRS-BA	8"	1	404	\$24,033

NOTE: Replace suffix -BA with suffix -PSA for Pennsylvania Steel Act compliant backflow preventers.

STAINLESS STEEL BODY AND NRS GATE VALVES GROOVED CONNECTIONS

Model Number	Size	Qty. per Carton	Weight per Carton (Lbs.)	List Price (Each)
FRP2.50-SS-NRS-G-BA	2/1/2"	1	99	\$5,687
FRP3.00-SS-NRS-G-BA	3"	1	114	\$5,856
FRP4.00-SS-NRS-G-BA	4"	1	143	\$6,485
FRP6.00-SSX-NRS-G-BA	6"	1	283	\$9,223
FRP8.00-SS-NRS-G-BA	8"	1	384	\$24,033

NOTE: Replace suffix -BA with suffix -PSA for Pennsylvania Steel Act compliant backflow preventers.

STAINLESS STEEL BODY AND NRS GATE VALVES FLANGED CONNECTIONS STRAINER ATTACHED

Model Number	Size	Qty. per Carton	Weight per Carton (Lbs.)	List Price (Each)
FRP2.50-SS-NRS-S-BA	2/1/2"	1	139	\$6,142
FRP3.00-SS-NRS-S-BA	3"	1	158	\$6,537
FRP4.00-SS-NRS-S-BA	4"	1	213	\$7,305
FRP6.00-SSX-NRS-S-BA	6"	1	428	\$10,790
FRP8.00-SS-NRS-S-BA	8"	1	679	\$27,256

NOTE: Replace suffix -BA with suffix -PSA for Pennsylvania Steel Act compliant backflow preventers.

CALIFORNIA PROPOSITION 65 WARNING. This product contains chemicals known to the State of California to cause cancer and birth defects or other reproductive harm.

BARRACUDA 40 FRP - REDUCED PRESSURE ZONE STAINLESS STEEL BACKFLOW PREVENTERS MEET BUY AMERICA AND PSA STANDARDS WITH SUFFIX -BA / -PSA SELECTED

STAINLESS STEEL BODY AND OSY GATE VALVES FLANGED CONNECTIONS

Model Number	Size	Qty. per Carton	Weight per Carton (Lbs.)	List Price (Each)
FRP2.50-SS-OSY-BA	2 1/2"	1	124	\$5,761
FRP3.00-SS-OSY-BA	3"	1	148	\$6,014
FRP4.00-SS-OSY-BA	4"	1	169	\$6,683
FRP6.00-SSX-OSY-BA	6"	1	331	\$9,327
FRP8.00-SS-OSY-BA	8"	1	414	\$25,152

NOTE: Replace suffix -BA with suffix -PSA for Pennsylvania Steel Act compliant backflow preventers.

STAINLESS STEEL BODY AND OSY GATE VALVES GROOVED CONNECTIONS

Model Number	Size	Qty. per Carton	Weight per Carton (Lbs.)	List Price (Each)
FRP2.50-SS-OSY-G-BA	2 1/2"	1	119	\$5,761
FRP3.00-SS-OSY-G-BA	3"	1	142	\$6,014
FRP4.00-SS-OSY-G-BA	4"	1	159	\$6,683
FRP6.00-SSX-OSY-G-BA	6"	1	316	\$9,327
FRP8.00-SS-OSY-G-BA	8"	1	394	\$25,152

NOTE: Replace suffix -BA with suffix -PSA for Pennsylvania Steel Act compliant backflow preventers.

STAINLESS STEEL BODY AND OSY GATE VALVES FLANGED CONNECTIONS STRAINER ATTACHED

Model Number	Size	Qty. per Carton	Weight per Carton (Lbs.)	List Price (Each)
FRP2.50-SS-OSY-S-BA	2 1/2"	1	159	\$6,336
FRP3.00-SS-OSY-S-BA	3"	1	186	\$6,664
FRP4.00-SS-OSY-S-BA	4"	1	229	\$7,435
FRP6.00-SSX-OSY-S-BA	6"	1	461	\$11,188
FRP8.00-SS-OSY-S-BA	8"	1	689	\$27,461

NOTE: Replace suffix -BA with suffix -PSA for Pennsylvania Steel Act compliant backflow preventers.



2 1/2 - 8"

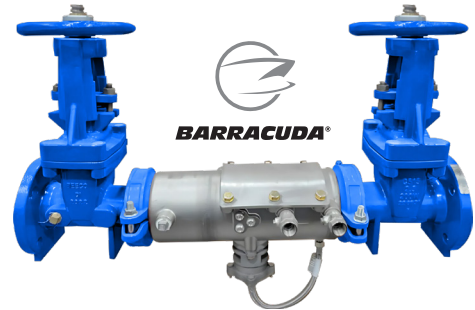

FRP2.50-SS-OSY-BA (ILLUSTRATED)
FOR SPEC. SHEETS GO TO
www.beecobackflow.com

Function: The BEECO® Series Barracuda 40 REDUCED PRESSURE VALVE Backflow Prevention Valve prevents non-health hazardous pollutants and hazardous contaminants from entering a potable water supply system when backpressure and/or backsiphonage conditions occur. This product is designed for the waterwork, plumbing, and irrigation markets only.

Sizes: 2 1/2", 3", 4", 6"(x), 8"

Working Pressure:
10-175psi (0.7-12.1 bar)

Temperature Range:
33°-140°F (1°-60°C)

Flanged Ends:
ANSI B16.1 Class 125

Lead Free: Patents:
0.25% Maximum by Weight



WATER QUALITY
ANSI/NSF/CAN 372
(MH63779)



"As someone representing their products, MIFAB makes me feel like they are in the trenches with me. They are a partner who understands and supports us."

- Tom Babcock of Kast Marketing, Chicago, IL

CALIFORNIA PROPOSITION 65 WARNING. This product contains chemicals known to the State of California to cause cancer and birth defects or other reproductive harm.

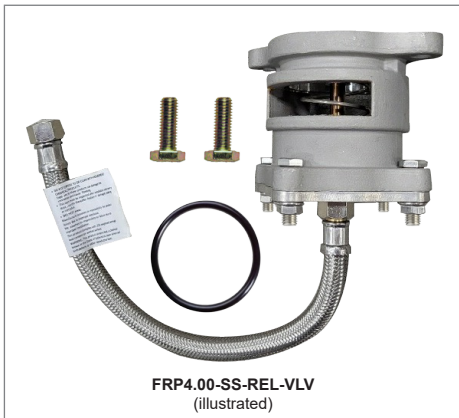
REPLACEMENT CHECKS FOR BARRACUDA BACKFLOW PREVENTERS

REPLACEMENT CHECKS FOR BARRACUDA VALVES

Model Number	Size	Qty. per Carton	Weight per Carton (Lbs.)	List Price (Each)
FRP4.00-SS-CHECK-1ST	2 1/2"-4"	1	2	\$802
FRP4.00-SS-CHECK-2ND	2 1/2"-4"	1	2	\$990
FDC4.00-SS-CHECK-1ST	2 1/2"-4"	1	2	\$802
FDC4.00-SS-CHECK-2ND	2 1/2"-4"	1	2	\$990
FRP8.00-SS-CHECK-1ST	6"-8"	1	4	\$1,788
FRP8.00-SS-CHECK-2ND	6"-8"	1	4	\$1,581
FDC8.00-SS-CHECK-1ST	6"-8"	1	4	\$1,581
FDC8.00-SS-CHECK-2ND	6"-8"	1	4	\$1,581

RUBBER REPAIR KITS FOR BARRACUDA VALVES

Model Number	Size	Qty. per Carton	Weight per Carton (Lbs.)	List Price (Each)
FDC-FRP4.0-SS-RUBKIT	2 1/2"-4"	1	1	\$340
FDC-FRP8.0-SS-RUBKIT	6"-8"	1	1	\$641
FRP2-8-SS-RELIEF-KIT	2 1/2"-8"	1	2	\$533
FRP4.00-SS-REL-VLV	2 1/2"-4"	1	2	\$1,931
FRP8.00-SS-REL-VLV	6"-8"	1	2	\$1,931

"Thanks to your catalogue, we find it easy to navigate the pages and place an order. The detailed information shown there helps us to match the size of the unit for replacement of existing grease traps. The plastic grease trap distribution program is very user friendly and has helped to increase our sales dramatically." - Bill Cornwell, Manager, Bucks Wholesale Supply, Tampa, FL

CALIFORNIA PROPOSITION 65 WARNING. This product contains chemicals known to the State of California to cause cancer and birth defects or other reproductive harm.

AG SERIES (AIR GAPS)

AIR GAPS FOR RELIEF VALVES

Model Number	Size	Qty. per Carton	Weight per Carton (Lbs.)	List Price (Each)
AG1.00	1/2" thru 1"	1	2	\$67
AG2.00	1 1/4" thru 2"	1	3	\$76
AG6.00	2 1/2" thru 6"	1	5	\$87
AG6.00-90	2 1/2" thru 6"	1	5	\$55
AG10.00	8" and 10"	1	8	\$109
AG10.00-90	8" and 10"	1	8	\$75



AG1.00 (ILLUSTRATED)
FOR SPEC. SHEETS GO TO
www.beecobackflow.com

AIR GAPS FOR BARRACUDA 40 FRP SERIES

Model Number	Size	Qty. per Carton	Weight per Carton (Lbs.)	List Price (Each)
AG4.00-SS	2 1/2" thru 4"	1	2	\$220
AG8.00-SS	6" and 8"	1	3	\$264

FUNCTION: BEECO® Air Gaps provide the unobstructed, physical separation between the discharge end of a potable water supply line and an open receiving vessel.

MATERIAL: The BEECO® Air Gaps are made of cast iron and fusion-bonded epoxy coating to keep them rust free.

SPOOLS AND SPACERS

RIGID PIPE COUPLINGS

Model Number	Size	Qty. per Carton	Weight per Carton (Lbs.)	List Price (Each)
SP2.50	2 1/2"	1		\$1,288
SP3.00	3"	1		\$1,460
SP4.00	4"	1		\$2,287
SP6.00	6"	1		\$3,651
SP8.00	8"	1		\$4,997
SP10.00	10"	1		\$6,343



SP6.00 (ILLUSTRATED)
FOR SPEC. SHEETS GO TO
www.beecobackflow.com

BEECO® Spools and Spacers are designed for retrofitting backflow prevention assemblies, Automatic Control Valves or other piping system installations into spaces where a longer lay length exists. Spools are available in fused bonded epoxy coated carbon steel and come standard with AWWA 150# class "D" carbon steel flanges.

CALIFORNIA PROPOSITION 65 WARNING. This product contains chemicals known to the State of California to cause cancer and birth defects or other reproductive harm.

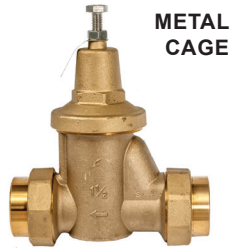
PRV (PRESSURE REDUCING VALVES)

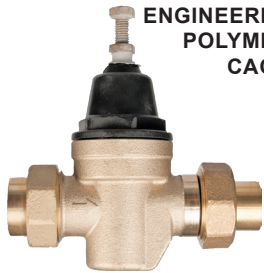
**METAL
CAGE**
PRV1.50-DU-IPS-C-LL (ILLUSTRATED)

 FOR SPEC. SHEETS GO TO
www.beecobackflow.com

**ENGINEERED
POLYMER
CAGE**
PRV.75-DU-IPS-C-LL (ILLUSTRATED)

 FOR SPEC. SHEETS GO TO
www.beecobackflow.com
BODY: Bronze

INTEGRAL STRAINER: Stainless Steel

VALVE DISC: EPDM

SEAT: Replaceable Engineered Polymer

DIAPHRAGM: Reinforced EPDM

TEMPERATURE RANGE:

33 - 180 Degree F (0.5 - 82 Degree C)

WORKING PRESSURE:

300 psi (20.7 bar)

PRESSURE RANGE:

25-75 psi (172-517kPa)

STANDARD PRESSURE SET:

50psi (345 kPa)

APPROVALS:

 Valves are tested and certified to ASSE 1003-2020,
 CSA B356-2010 & listed with IAPMO

Tested and certified to NSF 61 and NSF 372

* See page 64 for Cross Reference to competitor's models

CALIFORNIA PROPOSITION 65 WARNING. This product contains chemicals known to the State of California to cause cancer and birth defects or other reproductive harm.

DOUBLE UNION, THREADED FEMALE INLET AND OUTLET

Model Number	Size	Qty. per Carton	Weight per Carton (Lbs.)	List Price (Each)
PRV.50-DU-IPS-C-LL	1/2"	24	40	\$122
PRV.75-DU-IPS-C-LL	3/4"	24	40	\$122
PRV1.00-DU-IPS-C-LL	1"	16	36	\$171
PRV1.25-DU-IPS-C-LL	1 1/4"	6	24	\$479
PRV1.50-DU-IPS-C-LL	1 1/2"	6	26	\$533
PRV2.00-DU-IPS-C-LL	2"	6	26	\$616

* See page 64 for Cross Reference to competitor's models

NOTE: ALL 1/2", 3/4" AND 1" MODELS ARE MANUFACTURED WITH AN ENGINEERED POLYMER CAGE. 1 1/4", 1 1/2" AND 2" MODELS ARE MANUFACTURED WITH A BRONZE CAGE.

DOUBLE UNION, SOLDER UNION INLET AND OUTLET

Model Number	Size	Qty. per Carton	Weight per Carton (Lbs.)	List Price (Each)
PRV.50-DU-SWT-C-LL	1/2"	24	40	\$122
PRV.75-DU-SWT-C-LL	3/4"	24	40	\$122
PRV1.00-DU-SWT-C-LL	1"	16	34	\$171
PRV1.25-DU-SWT-C-LL	1 1/4"	6	24	\$479
PRV1.50-DU-SWT-C-LL	1 1/2"	6	26	\$533
PRV2.00-DU-SWT-C-LL	2"	6	26	\$616

* See page 64 for Cross Reference to competitor's models

SINGLE UNION, THREADED FEMALE INLET AND OUTLET

Model Number	Size	Qty. per Carton	Weight per Carton (Lbs.)	List Price (Each)
PRV.50-SU-IPS-C-LL	1/2"	24	36	\$103
PRV.75-SU-IPS-C-LL	3/4"	24	36	\$103
PRV1.00-SU-IPS-C-LL	1"	16	30	\$142

* See page 64 for Cross Reference to competitor's models

SINGLE UNION, SOLDER UNION INLET & THREADED FEMALE OUTLET

Model Number	Size	Qty. per Carton	Weight per Carton (Lbs.)	List Price (Each)
PRV.50-SU-SWT-C-LL	1/2"	24	36	\$103
PRV.75-SU-SWT-C-LL	3/4"	24	36	\$103
PRV1.00-SU-SWT-C-LL	1"	16	30	\$142

PRV (PRESSURE REDUCING VALVES)

DOUBLE UNION, CPVC FEMALE INLET AND OUTLET

Model Number	Size	Qty. per Carton	Weight per Carton (Lbs.)	List Price (Each)
PRV.50-DU-CPVC-C-LL	1/2"	24	36	\$121
PRV.75-DU-CPVC-C-LL	3/4"	24	36	\$121
PRV1.00-DU-CPVC-C-LL	1"	16	30	\$159

* See page 64 for Cross Reference to competitor's models

Note: All 1/2", 3/4" and 1" models are manufactured with an engineered polymer cage. 1 1/4", 1 1/2" & 2" models are manufactured with a bronze cage.

DOUBLE UNION, PEX INLET AND OUTLET PVC BONNET

Model Number	Size	Qty. per Carton	Weight per Carton (Lbs.)	List Price (Each)
PRV.50-DU-PEX-C-LL	1/2"	24	36	\$121
PRV.75-DU-PEX-C-LL	3/4"	24	36	\$121
PRV1.00-DU-PEX-C-LL	1"	16	30	\$159

* See page 64 for Cross Reference to competitor's models

DOUBLE UNION, PRESS INLET AND OUTLET PVC BONNET

Model Number	Size	Qty. per Carton	Weight per Carton (Lbs.)	List Price (Each)
PRV.50-DU-PRESS-C-LL	1/2"	24	36	\$121
PRV.75-DU-PRESS-C-LL	3/4"	24	36	\$121
PRV1.00-DU-PRESS-C-LL	1"	16	30	\$159

* See page 64 for Cross Reference to competitor's models

LOW PRESSURE PRV 15PSI TO 75PSI SINGLE UNION IPS

Model Number	Size	Qty. per Carton	Weight per Carton (Lbs.)	List Price (Each)
PRV.50-SU-IPS-LP-LL	1/2"	24	36	\$103
PRV.75-SU-IPS-LP-LL	3/4"	24	36	\$103
PRV1.00-SU-IPS-LP-LL	1"	16	30	\$142

* See page 64 for Cross Reference to competitor's models

ALSO AVAILABLE IN DU AND IN SWT PLEASE CONSULT FACTORY

PRV WITH METAL CAGES

Model Number	Size	Qty. per Carton	Weight per Carton (Lbs.)	List Price (Each)
PRV.50-DU-IPS-C-MCLL	1/2"	24	36	\$133
PRV.75-DU-IPS-C-MCLL	3/4"	24	36	\$133
PRV1.00-DU-IPS-C-MCLL	1"	16	30	\$171

* See page 64 for Cross Reference to competitor's models



PRV.75-DU-CPVC-C-LL (ILLUSTRATED)

FOR SPEC. SHEETS GO TO www.beecobackflow.com

COMPONENTS

BODY: Bronze
INTEGRAL STRAINER: Stainless Steel
VALVE DISC: EPDM
SEAT: Replaceable Engineered Polymer
DIAPHRAGM: Reinforced EPDM

TEMPERATURE RANGE:
 33-180 Deg. F (0.5 Deg. C - 82 Deg. C)

WORKING PRESSURE:

300 psi (2068 kPa)

PRESSURE RANGE:

25-75 psi (172-517kPa)

STANDARD PRESSURE SET:

50psi (345 kPa)

APPROVALS:

Valves are tested and certified to ASSE 1003-2020, CSA B356-2010 & listed with IAPMO



Tested and certified to NSF 61 and NSF 372 Lead Free requirements.

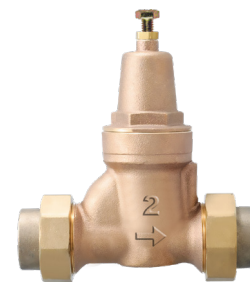

PRV2.00-DU-IPS-C (ILLUSTRATED)

FOR SPEC. SHEETS GO TO www.beecobackflow.com

"The Brass cap is a big plus to some of my customers that do work in the desert communities as sun-UV attack the nylon on your competitors, plumbers have mentioned it is a very cleanly made product with no problems on installation"

- Rob Scott, Owner Action Plumbing Supply

CALIFORNIA PROPOSITION 65 WARNING. This product contains chemicals known to the State of California to cause cancer and birth defects or other reproductive harm.



Distributed by: **MIFAB**

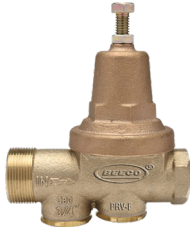

PRV1.00-SU-IPS-F-LL (ILLUSTRATED)
FOR SPEC. SHEETS GO TO
www.beecobackflow.com

Matches 25AUB length and union threads

APPROVALS:

Valves are tested and certified to ASSE 1003-2020,
CSA B356-2010 & listed with IAPMO



Tested and certified to NSF 61 and
NSF 372 Lead Free requirements.

**PRV-F - PRESSURE REDUCING VALVES COMPETITIVE
FIELD REPLACEMENT**

**BRONZE BODY UNION KIT, ONE THREADED CONNECTION AND ONE
FILTER SCREEN**

Model Number	Size	Qty. per Carton	Weight per Carton (Lbs.)	List Price (Each)
PRV.50-SU-IPS-F-LL	1/2"	18	63	\$225
PRV.75-SU-IPS-F-LL	3/4"	18	63	\$235
PRV1.00-SU-IPS-F-LL	1"	12	78	\$347
PRV1.25-SU-IPS-F-LL	1 1/4"	6	43	COMING SOON
PRV1.50-SU-IPS-F-LL	1 1/2"	6	43	COMING SOON
PRV2.00-SU-IPS-F-LL	2"	6	43	COMING SOON

CALIFORNIA PROPOSITION 65 WARNING. This product contains chemicals known to the State of California to cause cancer and birth defects or other reproductive harm.

PRESSURE REDUCING VALVE UNION KITS

UNION KIT, ONE UNION SOLDER CONNECTION AND ONE FILTER SCREEN

Model Number	Size	Qty. per Carton	Weight per Carton (Lbs.)	List Price (Each)
PRV.50-SU-SWT-LL-KIT	1/2"	1	1	\$13
PRV.75-SU-SWT-LL-KIT	3/4"	1	1	\$13
PRV1.00-SU-SWT-LL-KIT	1"	1	2	\$21
PRV1.25-SU-SWT-LL-UK	1 1/4"	1	2	\$54
PRV1.50-SU-SWT-LL-UK	1 1/2"	1	2	\$54
PRV2.00-SU-SWT-LL-UK	2"	1	3	\$83



PRV.75-SU-SWT-KIT (ILLUSTRATED)

FOR SPEC. SHEETS GO TO
www.beecobackflow.com

Jumper Kits are used in new home construction as a temporary by pass. Jumper Kits allow for flushing, testing and cleaning of the piping system. They also deter theft and vandalism on unsecured job sites.

UNION KIT, ONE THREADED CONNECTION AND ONE FILTER SCREEN

Model Number	Size	Qty. per Carton	Weight per Carton (Lbs.)	List Price (Each)
PRV.50-SU-IPS-LL-KIT	1/2"	1	1	\$13
PRV.75-SU-IPS-LL-KIT	3/4"	1	1	\$13
PRV1.00-SU-IPS-LL-KIT	1"	1	2	\$21
PRV1.25-SU-IPS-LL-UK	1-1/4"	1	2	\$48
PRV1.50-SU-IPS-LL-UK	1-1/2"	1	2	\$72
PRV2.00-SU-IPS-LL-UK	2"	1	3	\$88



PRV.75-SU-IPS-KIT (ILLUSTRATED)

FOR SPEC. SHEETS GO TO
www.beecobackflow.com

COMPLETELY ASSEMBLED JUMPER KIT (THREADED CONNECTIONS)

Model Number	Size	Qty. per Carton	Weight per Carton (Lbs.)	List Price (Each)
PRV.50-IPS-JK	1/2"	6	10	\$48
PRV.75-IPS-JK	3/4"	6	12	\$48
PRV1.00-IPS-JK	1"	6	14	\$62
PRV1.25-IPS-JK	1 1/4"	1	2	\$150
PRV1.50-IPS-JK	1 1/2"	1	3	\$197
PRV2.00-IPS-JK	2"	1	4	\$260



PRV.50-SWT-JK (ILLUSTRATED)

FOR SPEC. SHEETS GO TO
www.beecobackflow.com

COMPLETELY ASSEMBLED JUMPER KIT (SWEAT CONNECTIONS)

Model Number	Size	Qty. per Carton	Weight per Carton (Lbs.)	List Price (Each)
PRV.50-SWT-JK	1/2"	6	10	\$35
PRV.75-SWT-JK	3/4"	6	12	\$36
PRV1.00-SWT-JK	1"	6	14	\$62
PRV1.25-SWT-JK	1 1/4"	1	2	\$150
PRV1.50-SWT-JK	1 1/2"	1	3	\$177
PRV2.00-SWT-JK	2"	1	4	\$260

JK (JUMPER KITS) COMPACT DESIGN ONLY

JUMPER KIT, PLASTIC SPOOL, NO UNION CONNECTIONS

Model Number	Size	Qty. per Carton	Weight per Carton (Lbs.)	List Price (Each)
PRV.50-JK-BODY	1/2" & 3/4"	1	1	\$21
PRV1.00-JK-BODY	1"	1	1	\$27
PRV1.25-JK-BODY	1 1/4"	1	1	\$40
PRV1.50-JK-BODY	1 1/2"	1	1	\$54
PRV2.00-JK-BODY	2"	1	1	\$83



PRV1.25-JK-BODY (ILLUSTRATED)

FOR SPEC. SHEETS GO TO
www.beecobackflow.com

CALIFORNIA PROPOSITION 65 WARNING. This product contains chemicals known to the State of California to cause cancer and birth defects or other reproductive harm.

BEECO® AUTOMATIC CONTROL VALVES

BEECO® Automatic Control Valves are used in a variety of Commercial Plumbing, Industrial and Institutional control applications. They are actuated by various hydraulic and/or electric pilot controls, and utilize line pressure to perform a wide range of On-Off, Regulating, and Combination control functions.

- **PRESSURE REDUCING**
- **SOLENOID (On-Off) CONTROL**
- **LIQUID LEVEL CONTROL**
- **FLOW CONTROL**
- **PRESSURE RELIEF, SUSTAINING, & BACKPRESSURE CONTROL**
- **SYSTEM SAFETY & PROTECTION CONTROL**

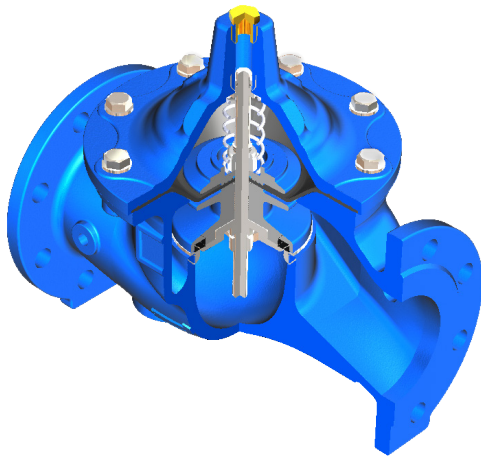

BEECO® Automatic Control Valves are constructed of ductile iron and are 100% coated with an extremely durable, high-quality electrostatic fusion bonded epoxy coating as standard. They are available in 2"-8" Full Port ANSI 150 class flanges. Every BEECO® Automatic Control Valve is hydrostatically tested to ensure peak performance.

FEATURES:

- DUCTILE IRON BODY & COVER
- STAINLESS STEEL SEAT DISK AND STEM
- "NEAR-ZERO" LOW FLOW PERFORMANCE
- EPDM RUBBER COMPONENTS
- ISO STANDARD LENGTHS AND DIMENSIONS
- CERTIFIED LEAD FREE

REPAIR PARTS FOR ACV WITH -T

PILOT TO CONTROL ACV

Model Number	Size	Qty. per Carton	Weight per Carton (Lbs.)	List Price (Each)
ACV2-5.00-T-PILOT	2" to 5"	1	1	\$402.00
ACV6-8.00-T-PILOT	6" to 8"	1	2	\$1,198.00
ACV4.00-T-DIAPHRAGM	2" to 4"	1	1	\$95.00
ACV6.00-T-DIAPHRAGM	6"	1	1	\$120.00

CALIFORNIA PROPOSITION 65 WARNING. This product contains chemicals known to the State of California to cause cancer and birth defects or other reproductive harm.

ACV (AUTOMATIC CONTROL VALVES)

FULL PORT HIGH FLOW PRESSURE REDUCING VALVES

FLANGED BY FLANGED (ANSI 150)

Model Number	Size	Qty. per Carton	Weight per Carton (Lbs.)	List Price (Each)
ACV2.00-HF-T-PR	2"	1	30	\$1,550
ACV2.50-HF-T-PR	2.5"	1	35	\$1,850
ACV3.00-HF-T-PR	3"	1	53	\$2,100
ACV4.00-HF-T-PR	4"	1	71	\$2,950
ACV6.00-HF-T-PR	6"	1	189	\$4,900
ACV8.00-HF-T-PR	8"	1	330	\$9,500

SUFFIX	OPTIONAL VARIATIONS
-PS	PRESSURE SUSTAINING
-FL	FLOAT VALVE
-ALT	ALTITUDE CONTROL
-ALT-B	BI-LEVEL ALTITUDE CONTROL



ARV (ILLUSTRATED)
FOR SPEC. SHEETS GO TO
www.beecobackflow.com

WORKING PRESSURE: 250 psi
BODY & COVER: Epoxy Coated Ductile Iron
ELASTOMERS: EPDM
TUBING/FITTINGS: Reinforced Nylon w/ Brass Fittings
CONTROL PILOT(S): Bronze / Brass

BEECO® ACV Pilot Operated Pressure Reducing Valve Cross Reference

MODEL	SIZE	BEECO®	WILKINS	WATTS	CLA-VAL	SINGER	BERMAD	OCV
		ACV	ZW209	LF115F OR M	90-01	106-PR	720	127-3
ACV-PR	2"	ACV2.00-HF-T-PR	2-ZW209	2" LFF115	90-01	2" 106-PR	2" 720	2" 127-3
ACV-PR	2-1/2"	ACV2.50-HF-T-PR	212-ZW209	2 1/2" LFF115	90-01	2-1/2" 106-PR	2-1/2" 720	2-1/2" 127-3
ACV-PR	3"	ACV3.00-HF-T-PR	3-ZW209	3" LFF115	90-01	3" 106-PR	3" 720	3" 127-3
ACV-PR	4"	ACV4.00-HF-T-PR	4-ZW209	4" LFF115	90-01	4" 106-PR	4" 720	4" 127-3
ACV-PR	6"	ACV6.00-HF-T-PR	6-ZW209	6" LFF115	90-01	6" 106-PR	6" 720	6" 127-3
ACV-PR	8"	ACV8.00-HF-T-PR	8-ZW209	8" LFF115	90-01	8" 106-PR	8" 720	8" 127-3

BEECO® ACV PILOT OPERATED VALVE CROSS REFERENCE

MODEL	SIZE	BEECO®	WILKINS	WATTS (F OR M MODEL)	CLA-VAL	SINGER	BERMAD	OCV
PRESSURE SUSTAINING								
ACV		ACV#.#-HF-T-PS	ZW205	LFF116	50-01	106-RPS	730	108-2
FLOAT VALVE								
ACV		ACV#.#-HF-T-FL	ZW204	110-14	124-01	106-F	750-60	8000
ALTITUDE CONTROL								
ACV		ACV#.#-HF-T-ALT	ZW221	127-1	210-01	106A-TYPEII	780-AX	3331
BI-LEVEL ALTITUDE CONTROL								
ACV		ACV#.#-HF-T-ALT-B	ZW222	127-2	210-2	106A-TYPEI	780-70-AX	3333

Part numbers match same format as pressure reducing valve section

CALIFORNIA PROPOSITION 65 WARNING. This product contains chemicals known to the State of California to cause cancer and birth defects or other reproductive harm.



ACV4.00-HF-PR (SHOWN WITH OPTIONAL STAINLESS STEEL PILOT CONTROL SYSTEM)
 FOR SPEC. SHEETS GO TO
www.beecobackflow.com

BEECO® -HF-PR Series Full Port Pressure Reducing Valves are designed to reduce a fluctuating high upstream pressure to an adjustable constant lower downstream pressure regardless of varying flow demand.

ACV (AUTOMATIC CONTROL VALVES)

FLANGED BY FLANGED (ANSI 150)

Model Number	Size	Qty. per Carton	Weight per Carton (Lbs.)	List Price (Each)
ACV1.50-HF-PR	1 1/2"	1	32	P.O.A.
ACV2.00-HF-PR	2"	1	32	P.O.A.
ACV10.00-HF-PR	10"	1	545	P.O.A.

* See page 64 for Cross Reference to competitor's models

"Another manufacturer dropped the ball and I was able to get a BEECO® ACV PRV quickly. The customer was skeptical because it looked different due to not having a bypass. The rep assured him it was not needed with a BEECO® ACV and walked him through the installation"

- Brian Churilla, National Plumbing & Heating



SCV2.00-FLG-SS (ILLUSTRATED)
 FOR SPEC. SHEETS GO TO
www.beecobackflow.com

BEECO® SCV Series Flanged Silent Check Valves are spring loaded double guided check valves which close quickly preventing reverse flow and reduce water hammer.

WORKING PRESSURE: 200 psi

BODY: Epoxy Coated Cast Iron

FLANGES: ANSI 125 B16.1

DISC & SEAT: 304 Stainless Steel

DISC TRIM: EPDM

TEMPERATURE: 15°F to 250°F

SCV (SILENT CHECK VALVES)

FLANGED SILENT CHECK VALVE (ANSI 125)

Model Number	Size	Qty. per Carton	Weight per Carton (Lbs.)	List Price (Each)
SCV2.00-FLG-SS	2"	1	17	P.O.A.
SCV8.00-FLG-SS	8"	1	133	P.O.A.

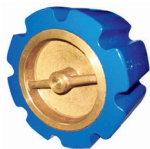

WSCV10.00 (ILLUSTRATED)
 FOR SPEC. SHEETS GO TO
www.beecobackflow.com

BEECO® WSCV Series Wafer Silent Check Valves are spring loaded double guided check valves which close quickly preventing reverse flow and reduce water hammer.

WORKING PRESSURE: 200 psi

BODY: Epoxy Coated Cast Iron

BOLT PATTERN: ANSI 125 B16.1

DISC & SEAT: 304 Stainless Steel

DISC TRIM: EPDM

TEMPERATURE: 15°F to 250°F

WAFER SILENT CHECK VALVE

Model Number	Size	Qty. per Carton	Weight per Carton (Lbs.)	List Price (Each)
WSCV4.00	4"	1	20	P.O.A.
WSCV10.00	10"	1	123	P.O.A.

CALIFORNIA PROPOSITION 65 WARNING. This product contains chemicals known to the State of California to cause cancer and birth defects or other reproductive harm.

FCV (FLEX CHECK VALVES)

FLEX CHECK VALVE (ANSI 150)

Model Number	Size	Qty. per Carton	Weight per Carton (Lbs.)	List Price (Each)
FCV8.00	8"	1	264	P.O.A.



FCV6.00 (ILLUSTRATED)
FOR SPEC. SHEETS GO TO
www.beecobackflow.com

BEECO® Series FCV Flex Check Valve are designed to close quickly to reduce water hammer. The disc an approximate 35 degree travel from the full open to closed position. The valve has top entry access for ease of cleaning and inspection, and has a bottom plug for the addition of a back-flushing attachment.

"We have used the Mifab products for many years, especially the MR500 trap primer units. We have found them to be very reliable and competitively priced. We will continue to use them in the future." - Marc Griffin @ Texas PS

GV-OSY (GATE VALVES, OSY STYLE)

FLANGED BY FLANGED, OSY RESILIENT WEDGE, EPOXY COATED

Model Number	Size	Qty. per Carton	Weight per Carton (Lbs.)	List Price (Each)
GV2.50-FXF-OSY	2 1/2"	1	50	\$746
GV3.00-FXF-OSY	3"	1	60	\$952
GV4.00-FXF-OSY	4"	1	100	\$1,260
GV6.00-FXF-OSY	6"	1	160	\$2,007
GV8.00-FXF-OSY	8"	1	280	\$3,456
GV10.00-FXF-OSY	10"	1	440	\$5,258



GV6.00-FXF-OSY (ILLUSTRATED)
FOR SPEC. SHEETS GO TO
www.beecobackflow.com

GROOVED BY GROOVED, OSY RESILIENT WEDGE, EPOXY COATED

Model Number	Size	Qty. per Carton	Weight per Carton (Lbs.)	List Price (Each)
GV2.50-GXG-OSY	2 1/2"	1	40	\$620
GV3.00-GXG-OSY	3"	1	50	\$748
GV4.00-GXG-OSY	4"	1	85	\$992
GV6.00-GXG-OSY	6"	1	135	\$1,585
GV8.00-GXG-OSY	8"	1	220	\$2,736
GV10.00-GXG-OSY	10"	1	380	\$4,168



GV4.00-GXG-OSY (ILLUSTRATED)
FOR SPEC. SHEETS GO TO
www.beecobackflow.com

CALIFORNIA PROPOSITION 65 WARNING. This product contains chemicals known to the State of California to cause cancer and birth defects or other reproductive harm.



Distributed by: **MIFAB**

GROOVED BY GROOVED, OSY, UL & FM APPROVED

Model Number	Size	Qty. per Carton	Weight per Carton (Lbs.)	List Price (Each)
GV2.50-GXG-UL-OSY	2 1/2"	1	50	\$977
GV3.00-GXG-UL-OSY	3"	1	60	\$1,108
GV4.00-GXG-UL-OSY	4"	1	100	\$1,468
GV6.00-GXG-UL-OSY	6"	1	160	\$2,232
GV8.00-GXG-UL-OSY	8"	1	240	\$3,425
GV10.00-GXG-UL-OSY	10"	1	400	\$5,546

FLANGED BY FLANGED, OSY, UL & FM APPROVED

Model Number	Size	Qty. per Carton	Weight per Carton (Lbs.)	List Price (Each)
GV2.50-FXF-UL-OSY	2 1/2"	1	50	\$1,220
GV3.00-FXF-UL-OSY	3"	1	60	\$1,295
GV4.00-FXF-UL-OSY	4"	1	100	\$1,524
GV6.00-FXF-UL-OSY	6"	1	160	\$2,292
GV8.00-FXF-UL-OSY	8"	1	280	\$3,699
GV10.00-FXF-UL-OSY	10"	1	440	\$5,694

The BEECO® Series GV-FXF-OSY is a Flanged by Flanged OS&Y (Outside Screw and Yoke) Resilient Seated Gate Valve. It is manufactured in compliance with AWWA C515 Standard. Flanges are to ANSI B16.1, Class 125 drilling pattern. The body, bonnet, and wedge (disc) are of high strength ductile-iron, ASTM A536, Grade 65-45-12. The wedge is encapsulated with EPDM rubber. The stem and bolts are of stainless steel.

Function: Used in irrigation and water distribution systems as main shut off valves. The BEECO® Series GV-FXF-OSY is best used in the fully opened or fully closed position, but can be used as a throttling valve as required.

Features:

- UL Listed / FM Approved at 300 P.S.I. (20.8 bar) water working pressure rating.
- Fusion Bonded Interior and Exterior to AWWA C550 Standard.
- Pre-Grooved Stems for Installation of Tamper Switch.
- Complies with MSS SP-70 Standard.

"You can see and feel our business grow because of MIFAB."

- Dan Thomas of Ben Thomas and Associates, Shade Gap, PA

CALIFORNIA PROPOSITION 65 WARNING. This product contains chemicals known to the State of California to cause cancer and birth defects or other reproductive harm.

GV-OSY (GATE VALVES, OSY STYLE, UL & FM APPROVED)

FLANGED BY GROOVED				
Model Number	Size	Qty. per Carton	Weight per Carton (Lbs.)	List Price (Each)
GV2.50-FXG-UL-OSY	2 1/2"	1	45	\$1,001
GV3.00-FXG-UL-OSY	3"	1	55	\$1,119
GV4.00-FXG-UL-OSY	4"	1	90	\$1,499
GV6.00-FXG-UL-OSY	6"	1	145	\$2,258
GV8.00-FXG-UL-OSY	8"	1	260	\$3,548
GV10.00-FXG-UL-OSY	10"	1	420	\$5,591



GV6.00-FXF-UL-OSY (ILLUSTRATED)

FOR SPEC. SHEETS GO TO www.beecobackflow.com

FLANGED BY GROOVED, OSY RESILIENT WEDGE, EPOXY COATED				
Model Number	Size	Qty. per Carton	Weight per Carton (Lbs.)	List Price (Each)
GV2.50-FXG-OSY	2 1/2"	1	45	\$746
GV3.00-FXG-OSY	3"	1	55	\$952
GV4.00-FXG-OSY	4"	1	90	\$1,260
GV6.00-FXG-OSY	6"	1	145	\$2,007
GV8.00-FXG-OSY	8"	1	240	\$3,456
GV10.00-FXG-OSY	10"	1	400	\$5,258

The BEECO® Series GV-FXF-NRS is an AWWA C515 flange x flange resilient seated gate valve with a non-rising stem. Flanges are to ANSI B16.1, Class 125 drilling pattern. The body, bonnet, and wedge (disc) are of high strength ductile iron, ASTM A536, Grade 65-45-12. The wedge is encapsulated with EPDM rubber. The stem and bolts are of stainless steel.

Function: Used in irrigation and water distribution. The BEECO® Series GV-FXF-NRS is best used in the fully opened or fully closed position but can be used as a throttling valve.

Features:

- Available with Handwheel or Operating Nut.
- 300 P.S.I. (20.8 bar) water working pressure rating.
- Fusion Bonded Interior and Exterior to AWWA C550 Standard.

Ratings:

- Stems are heat treated stainless steel, more than twice as strong as brass stems. Highest working pressure rating of any valve in its class. 100% of all valves are hydrostatically tested at 2 x full rated working pressure. Proof of design tests include 5x working pressure and 1000 cycle tests. Temperature rated up to 180° F. (82° C)

GV-NRS (GATE VALVES, NRS STYLE)

FLANGED BY GROOVED, NRS RESILIENT WEDGE, EPOXY COATED				
Model Number	Size	Qty. per Carton	Weight per Carton (Lbs.)	List Price (Each)
GV2.50-FXG-NRS	2 1/2"	1	40	\$637
GV3.00-FXG-NRS	3"	1	55	\$811
GV4.00-FXG-NRS	4"	1	80	\$1,076
GV6.00-FXG-NRS	6"	1	140	\$1,710
GV8.00-FXG-NRS	8"	1	230	\$3,201
GV10.00-FXG-NRS	10"	1	365	\$4,476



GV3.00-FXG-NRS (ILLUSTRATED)

FOR SPEC. SHEETS GO TO www.beecobackflow.com

CALIFORNIA PROPOSITION 65 WARNING. This product contains chemicals known to the State of California to cause cancer and birth defects or other reproductive harm.



Distributed by: **MIFAB**



GV2.50-FXF-NRS (ILLUSTRATED)
FOR SPEC. SHEETS GO TO
www.beecobackflow.com

The BEECO® Series GV gate valves are AWWA C515 resilient seated gate valves with a non-rising stem. The body, bonnet, and wedge (disc) are of high strength ductile-iron, ASTM A536, Grade 65-45-12. The wedge is encapsulated with EPDM rubber. The stem and bolts are of stainless steel.

Function: Used in irrigation and water distribution. The BEECO® Series GV gate valves are best used in the fully opened or fully closed position, but can be used as a throttling valve.

Features:

- 2" Square Operating Nut.
- 300 P.S.I. (20.8 bar) water working pressure rating.
- Fusion Bonded Interior and Exterior to AWWA C550 Standard.

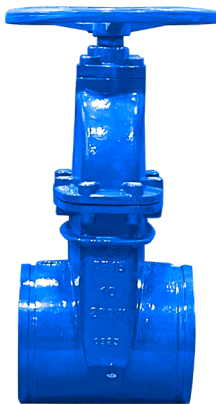

GV3.00-GXG-NRS (ILLUSTRATED)
FOR SPEC. SHEETS GO TO
www.beecobackflow.com

GV-NRS (GATE VALVES, NRS STYLE)

FLANGED BY FLANGED, NRS RESILIENT WEDGE, EPOXY COATED

Model Number	Size	Qty. per Carton	Weight per Carton (Lbs.)	List Price (Each)
GV2.00-FXF-NRS	2"	1	33	\$584
GV2.50-FXF-NRS	2 1/2"	1	37	\$637
GV3.00-FXF-NRS	3"	1	44	\$811
GV4.00-FXF-NRS	4"	1	57	\$1,076
GV6.00-FXF-NRS	6"	1	101	\$1,710
GV8.00-FXF-NRS	8"	1	154	\$3,201
GV10.00-FXF-NRS	10"	1	231	\$4,476
GV12.00-FXF-NRS	12"	1	350	\$6,160
GV14.00-FXF-NRS	14"	1	480	\$9,520
GV16.00-FXF-NRS	16"	1	616	\$13,104

GROOVED BY GROOVED, NRS RESILIENT WEDGE, EPOXY COATED

Model Number	Size	Qty. per Carton	Weight per Carton (Lbs.)	List Price (Each)
GV2.00-GXG-NRS	2"	1	25	\$571
GV2.50-GXG-NRS	2 1/2"	1	35	\$665
GV3.00-GXG-NRS	3"	1	45	\$726
GV4.00-GXG-NRS	4"	1	80	\$968
GV6.00-GXG-NRS	6"	1	120	\$1,541
GV8.00-GXG-NRS	8"	1	200	\$2,629
GV10.00-GXG-NRS	10"	1	355	\$4,050

"MIFAB wants to be a leader. To achieve this they continue to innovate and find new products."

- Tom Babcock of Kast Marketing, Chicago, IL

CALIFORNIA PROPOSITION 65 WARNING. This product contains chemicals known to the State of California to cause cancer and birth defects or other reproductive harm.

ECENTRIC PLUG VALVES

Model Number	Size	Qty. per Carton	Weight per Carton (Lbs.)	List Price (Each)
EPV4.00-FLG	4"	1	70	P.O.A.
EPV6.00-FLG	6"	1	136	P.O.A.
EPV8.00-FLG	8"	1	190	P.O.A.



EPV12.00-FLG (ILLUSTRATED)

FOR SPEC. SHEETS GO TO www.beecobackflow.com

BEECO® EPV Eccentric Plug Valves are used as isolation valves in wastewater systems. They feature a round port Ductile Iron EPDM coated plug and a 90% Nickel fully welded seat overlay for long seal life. 316 Stainless Steel Bearing is oil impregnated, permanently lubricated.

WORKING PRESSURE: 250 psi

BODY & BONNET: Epoxy Coated Ductile Iron
ASTM B536

FLANGES: ANSI 150 B16.5

SHAFT SEAL: EPDM V-Packing

TEMPERATURE: 15°F to 250°F

4" and smaller with Lever Handle

6" and larger with Gear Actuator

DIELECTRIC UNIONS

DIELECTRIC UNIONS, GALVANIZED, FEMALE IRON PIPE BY COPPER SOLDER JOINT

Model Number	Size	Qty. per Carton	Weight per Carton (Lbs.)	List Price (Each)
DU.50-IPS-X-SWT-LL	1/2"	10	5	\$8
DU.75-IPS-X-SWT-LL	3/4"	10	7	\$11
DU1.00-IPS-X-SWT-LL	1"	5	5	\$16
DU1.25-IPS-X-SWT-LL	1 1/4"	5	13	\$27
DU1.50-IPS-X-SWT-LL	1 1/2"	5	14	\$34
DU2.00-IPS-X-SWT-LL	2"	2	8	\$69

DIELECTRIC UNIONS, GALVANIZED, FEMALE IRON PIPE BY FEMALE IRON PIPE

Model Number	Size	Qty. per Carton	Weight per Carton (Lbs.)	List Price (Each)
DU.50-IPS-X-IPS	1/2"	10	5	\$9
DU.75-IPS-X-IPS	3/4"	10	7	\$13
DU1.00-IPS-X-IPS	1"	5	5	\$17
DU1.25-IPS-X-IPS	1 1/4"	5	12	\$28
DU1.50-IPS-X-IPS	1 1/2"	5	15	\$31
DU2.00-IPS-X-IPS	2"	2	8	\$59

LEAD FREE

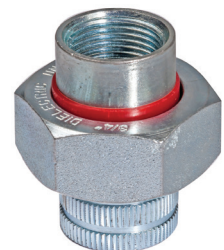

DU.75-IPS-X-IPS (ILLUSTRATED)

FOR SPEC. SHEETS GO TO www.beecobackflow.com

Note: Dielectric Unions that are IPS by IPS are not designated as -LL (lead free), but they do not have any copper or brass components.

"We receive very little negative feedback coming in for MIFAB."

- Dan Thomas, Ben Thomas and Associates, Shade Gap, PA

CALIFORNIA PROPOSITION 65 WARNING. This product contains chemicals known to the State of California to cause cancer and birth defects or other reproductive harm.

STR-DI-PC (STRAINERS (2" - 12"), DUCTILE IRON, POWDER COATED)

STR6.00-IRON-FLG-PC (ILLUSTRATED)
FOR SPEC. SHEETS GO TO
www.beecobackflow.com

**FLANGED (200WOG-125WSP), ANSI 125 WITH TAPPED CLOSURE
PLUG FUSED EPOXY POWDER COATED**

Model Number	Size	Qty. per Carton	Weight per Carton (Lbs.)	List Price (Each)
STR2.00-IRON-FLG-PC	2"	1	22	\$339
STR2.50-IRON-FLG-PC	2 1/2"	1	35	\$383
STR3.00-IRON-FLG-PC	3"	1	38	\$522
STR4.00-IRON-FLG-PC	4"	1	65	\$614
STR6.00-IRON-FLG-PC	6"	1	150	\$1,284
STR8.00-IRON-FLG-PC	8"	1	275	\$1,925
STR10.00-IRON-FLG-PC	10"	1	410	\$3,472
STR12.00-IRON-FLG-PC	12"	1	600	\$5,173



STR.50-IPS-BRZ-LL (ILLUSTRATED)
FOR SPEC. SHEETS GO TO
www.beecobackflow.com

The "Y" type strainer shall be a NO-LEAD strainer with a brass cap and a stainless steel mess screen. The valve shall be designed so the screen can be cleaned without removal of the valve from the pipe line and shall be equipped with a enclosure plug in the brass clean out cap for the addition of a test gauge or secondary water line.

BRONZE BODY: Standard NO-LEAD

RETAINER CAP: Brass Cap Gasket: NBR
STANDARD SCREEN: 304 Stainless Steel 20 Mesh

MAXIMUM WORKING PRESSURE:
400 P.S.I. (27.6 bar) WOG @ 210° F (99° C)

STR-IPS-LL (STRAINERS (1/2" - 2"), BRONZE, IPS)
WYE TYPE, THREADED CONNECTIONS

Model Number	Size	Qty. per Carton	Weight per Carton (Lbs.)	List Price (Each)
STR.50-IPS-BRZ-LL	1/2"	12	7	\$38
STR.75-IPS-BRZ-LL	3/4"	8	7	\$59
STR1.00-IPS-BRZ-LL	1"	8	11	\$93
STR1.25-IPS-BRZ-LL	1 1/4"	6	13	\$139
STR1.50-IPS-BRZ-LL	1 1/2"	2	6	\$211
STR2.00-IPS-BRZ-LL	2"	2	12	\$368

"We really like the C-PORT products. MIFAB overall has a great product offering with a wide selection. I have not had any issues with using MIFAB on a job. Also, the local representative is great !"

- Mike Bright, Arizona Pinnacle Engineering

CALIFORNIA PROPOSITION 65 WARNING. This product contains chemicals known to the State of California to cause cancer and birth defects or other reproductive harm.

BEECO® AIR RELEASE VALVES

Model Number	Description
AV-MH-K	Air & Vacuum Valve
AV-MH-KA	Combination Air Release and Air & Vacuum Valve
AV-MH-KA-SA	Combination Air Release and Air & Vacuum Valve with Surge Arresting Feature

BEECO® Air Release Valves are constructed of ductile iron and are 100% coated with an extremely durable high quality electrostatic fusion bonded polymer coating as standard. They are available in 2"-10" Full Port (-MH) and 3"-12" Reduced Port (-MS) designs, with both ANSI Class 150 and 300 Flanged (-HP) end connections.

Installed at pipeline high points, functions include Air Release (-A), Air & Vacuum (-K) and Combination Air Release and Air & Vacuum (-KA). An innovative adjustable surge arresting feature (-SA) is available for -KA Models.

BEECO® also offers a line of corrosion resistant Plastic Air Release (AV-P-A), Air & Vacuum (AV-P-K) and Combination Air Release and Air & Vacuum (AV-P-KA) Valves in sizes 1/2" through 2" MNPT.

PURPOSE

VENTING AIR FROM A FILLING PIPELINE

The standard valve allows the discharge of large volumes of air while the system is being filled with liquid, preventing water hammer. The valve remains open, even at very high air flow velocity (Fig. A), until the liquid reaches the float lifting it to the closed position (Fig. B).

VACUUM BREAKING (AIR INTAKE) OF A DRAINING PIPELINE

A decrease in system pressure to a negative value and the simultaneous drainage of the valve chamber causes the float to drop, allowing the admittance of air into the pipeline preventing negative pressure from causing potential pipeline collapse (Fig. C).

This function is available in Models with suffix -K and -KA.

RELEASE OF DISSOLVED AIR FROM A PRESSURIZED PIPELINE

Air that is released from liquid in a pressurized system, or is introduced into the system from open sources and/or pumping vortices, reduces system efficiency and causes water hammer. Air Release Valves installed at system high points allow air to accumulate in the valve chamber.

The accumulated air forces the liquid out of the valve chamber, reducing the upward force on the Bottom Float. As the Bottom Float drops, trapped air is vented through the small Nozzle in the center of the Top Float. As the liquid returns into the valve chamber the Bottom Float is lifted, sealing the Nozzle (Fig. D).

This function is available in Models with suffix -A and -KA only.

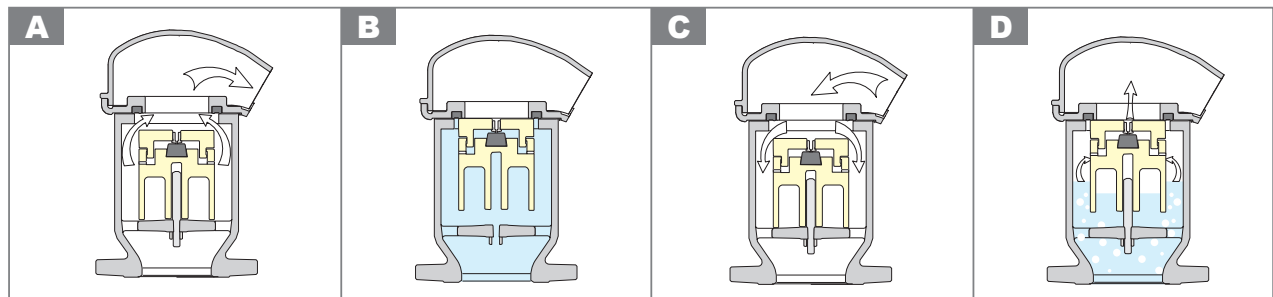

ADJUSTABLE SURGE ARRESTING FEATURE

BEECO® MH and MS Series Combination Air Release and Air & Vacuum Valves (-KA) can be fitted with a unique, adjustable, surge arresting feature (-SA). As air is exhausted from the pipeline, the optional (-SA) surge arresting feature limits the air outflow when the velocity exceeds the adjustable limit. This feature creates a temporary slow closing "air cushion", controlling potentially damaging water hammer in the pipeline.

CALIFORNIA PROPOSITION 65 WARNING. This product contains chemicals known to the State of California to cause cancer and birth defects or other reproductive harm.

AV4.00-MH-K (ILLUSTRATED)

 FOR SPEC. SHEETS GO TO
www.beecobackflow.com

BEECO® AV-MH-K Air & Vacuum Valves allow the discharge of large volumes of air while the pipeline is being filled preventing water hammer, and the admittance of air, preventing damaging negative pressure, while the system is being drained.

BEECO® AV-MH-KA Combination Air Release and Air & Vacuum Valves allow the discharge of large volumes of air while the pipeline is being filled, the admittance of air while the system is being drained, and vents air that accumulates while the pipeline is pressurized.

AV4.00-MH-KA-SA (ILLUSTRATED)

 FOR SPEC. SHEETS GO TO
www.beecobackflow.com

BEECO® Model AV-MH-KA-SA Valves perform all the functions of the AV-MH-KA, and include a unique patented Surge Arresting Feature (-SA). This feature limits air outflow when the velocity exceeds the adjustable limit, creating an "Air Cushion" to control potentially damaging water hammer.

AV4.00-MS-KA (ILLUSTRATED)

 FOR SPEC. SHEETS GO TO
www.beecobackflow.com

BEECO® AV-MS-KA Combination Air Release and Air & Vacuum Valves allow the discharge of large volumes of air while the pipeline is being filled, the admittance of air while the system is being drained, and vents air that accumulates while the pipeline is pressurized.

AIR RELEASE VALVES - MH SERIES
HIGH FLOW AIR & VACUUM VALVE (ANSI 150)

Model Number	Size	Qty. per Carton	Weight per Carton (Lbs.)	List Price (Each)
AV2.00-MH-K	2"	1	17	P.O.A.
AV3.00-MH-K	3"	1	27	P.O.A.
AV4.00-MH-K	4"	1	57	P.O.A.

HIGH FLOW COMBINATION VALVE (ANSI 150)

Model Number	Size	Qty. per Carton	Weight per Carton (Lbs.)	List Price (Each)
AV2.00-MH-KA	2"	1	17	P.O.A.
AV3.00-MH-KA	3"	1	27	P.O.A.
AV4.00-MH-KA	4"	1	57	P.O.A.

HIGH FLOW COMBINATION VALVE WITH SURGE ARRESTING FEATURE (ANSI 150)

Model Number	Size	Qty. per Carton	Weight per Carton (Lbs.)	List Price (Each)
AV2.00-MH-KA-SA	2"	1	17	P.O.A.
AV3.00-MH-KA-SA	3"	1	27	P.O.A.
AV4.00-MH-KA-SA	4"	1	57	P.O.A.

AIR RELEASE VALVES - MS SERIES
REDUCED PORT AIR & VACUUM VALVE (ANSI 150)

Model Number	Size	Qty. per Carton	Weight per Carton (Lbs.)	List Price (Each)
AV4.00-MS-K	4"	1	31	P.O.A.

REDUCED PORT COMBINATION VALVE (ANSI 150)

Model Number	Size	Qty. per Carton	Weight per Carton (Lbs.)	List Price (Each)
AV4.00-MS-KA	4"	1	31	P.O.A.

CALIFORNIA PROPOSITION 65 WARNING. This product contains chemicals known to the State of California to cause cancer and birth defects or other reproductive harm.

AIR RELEASE VALVES - AV (PLASTIC) SERIES

COMBINATION AIR RELEASE AND AIR & VACUUM VALVE

Model Number	Size	Qty. per Carton	Weight per Carton (Lbs.)	List Price (Each)
AV.50-P-KA	1/2"	25	20	\$515
AV.75-P-KA	3/4"	25	20	\$515
AV1.00-P-KA	1"	20	16	\$515
AV2.00-P-KA	2"	8	16	\$739

AV2.00-P-KA (ILLUSTRATED)

FOR SPEC. SHEETS GO TO
www.beecobackflow.com



BEECO® AV-P-KA Combination Air Release and Air & Vacuum Valves allow the discharge of large volumes of air while the pipeline is being filled, the admittance of air while the system is being drained, and vents small amounts of air that accumulate while the pipeline is pressurized.

**COMBINATION AIR VALVE
(AV-P-KA Series)**

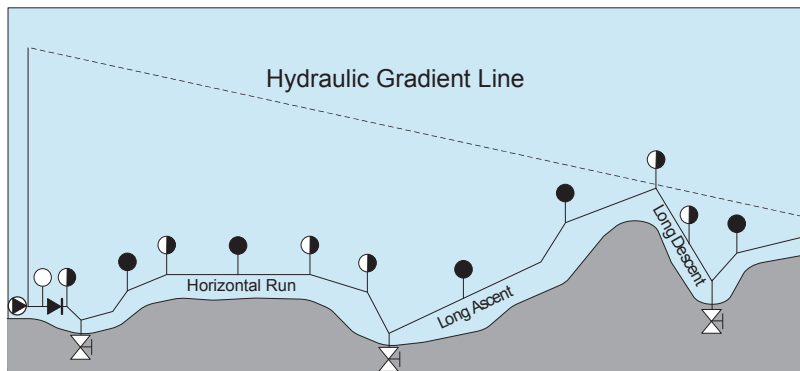
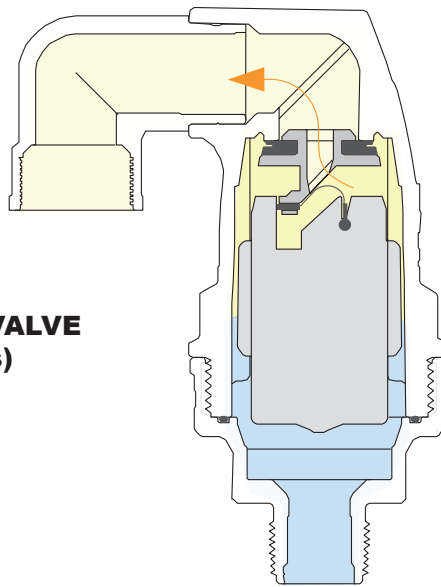

- Air and Vacuum Valve
- Air Release Valve
- ◐ Combination Air Valve
- ⊙ Pump
- ▶ Check Valve
- ⊠ Drain Valve
- Reservoir

"The BEECO® Plastic Air Valves provide dependable service at a competitive price, without the weight and corrosion concerns associated with metal valves." - William Dozier, CEO Pioneer Supply Moore, OK

CALIFORNIA PROPOSITION 65 WARNING. This product contains chemicals known to the State of California to cause cancer and birth defects or other reproductive harm.

AV4.00-WP-KA-CS-FL (ILLUSTRATED)

 FOR SPEC. SHEETS GO TO
www.beecobackflow.com

AV4.00-WP-KA-SS-FL (ILLUSTRATED)

 FOR SPEC. SHEETS GO TO
www.beecobackflow.com
AIR RELEASE VALVES - WP SERIES
SEWAGE AIR RELEASE VALVES COATED STEEL BODY

Model Number	Size	Qty. per Carton	Weight per Carton (Lbs.)	List Price (Each)
AV2.00-WP-KA-CS-TH	2" IPS	1	28	P.O.A.
AV2.00-WP-KA-CS-FL	2" FLANGED	1	33	P.O.A.
AV3.00-WP-KA-CS-FL	3" FLANGED	1	33	P.O.A.
AV4.00-WP-KA-CS-FL	4" FLANGED	1	40	P.O.A.

SEWAGE AIR RELEASE VALVES STAINLESS STEEL BODY

Model Number	Size	Qty. per Carton	Weight per Carton (Lbs.)	List Price (Each)
AV2.00-WP-KA-SS-TH	2" IPS	1	27	P.O.A.
AV2.00-WP-KA-SS-FL	2" FLANGED	1	28	P.O.A.
AV3.00-WP-KA-SS-FL	3" FLANGED	1	33	P.O.A.
AV4.00-WP-KA-SS-FL	4" FLANGED	1	40	P.O.A.

Designed especially designed for Wastewater Systems, BEECO® Models AV-WP-KA-SS and AV-WP-KA-CS Combination Air Release and Air & Vacuum Valves allow the discharge of large volumes of air while the pipeline is being filled preventing water hammer, and the admittance of air, preventing damaging negative pressure, when the system is drained. The valves also vent trapped air and gases that accumulate while the pipeline is pressurized.

The specially designed conical inlet reduces fluid velocity, also preventing water hammer. The extended body design lowers the Float, allowing the valve to efficiently operate while keeping fluid and suspended solids from fouling sealing mechanisms and avoiding atmospheric spillage. Valves are equipped with a side-mounted 1" NPT Stainless Steel Isolation Ball Valve for draining and flushing operations.

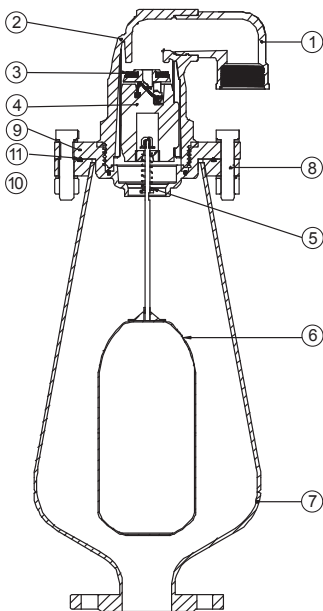
COMPONENTS

No	Description	Material
1	Bonnet elbow	PP
2	Bonnet	GRP
3	Seals	EPDM
4	Top Float	Foam PP
5	Spring	SS302
6	Main Float Sub. Assy.	SS316
7	Body	ST-37* or 316L SS
8	Bolt	SS316
9	Adapter Flange	PA
10	O Ring	NBR
11	O Ring	NBR

Three layer, UV protected epoxy coating *

CALIFORNIA PROPOSITION 65 WARNING. This product contains chemicals known to the State of California to cause cancer and birth defects or other reproductive harm.

BV-IPS-BRZ (BALL VALVES, BRONZE SERIES)

THREADED CONNECTIONS

Model Number	Size	Qty. per Carton	Weight per Carton (Lbs.)	List Price (Each)
BV.50-IPS-BRZ-LL	1/2"	6	6	\$28
BV.75-IPS-BRZ-LL	3/4"	6	8	\$38
BV1.00-IPS-BRZ-LL	1"	2	4	\$81
BV1.25-IPS-BRZ-LL	1 1/4"	2	6	\$86
BV1.50-IPS-BRZ-LL	1 1/2"	2	8	\$127
BV2.00-IPS-BRZ-LL	2"	1	6	\$213



BV.50-IPS-BRZ-LL (ILLUSTRATED)

FOR SPEC. SHEETS GO TO
www.beecobackflow.com

**LEAD
FREE**

The "Y" type strainer shall be a NO-LEAD strainer with a brass cap and a stainless steel mesh screen. The valve shall be designed so the screen can be cleaned without removal of the valve from the pipe line and shall be equipped with a enclosure plug in the brass clean out cap for the addition of a test gauge or secondary water line.

BRONZE BODY: Standard NO-LEAD

RETAINER CAP: Brass Cap Gasket: NBR
STANDARD SCREEN: 304 Stainless Steel 20 Mesh

MAXIMUM WORKING PRESSURE:
 400 P.S.I. (27.6 bar) WOG @ 210° F (99° C)

THREADED CONNECTIONS, LOCKING HANDLES

Model Number	Size	Qty. per Carton	Weight per Carton (Lbs.)	List Price (Each)
BV.50-IPS-BRZ-LH-LL	1/2"	20	12	\$38
BV.75-IPS-BRZ-LH-LL	3/4"	20	22	\$49
BV1.00-IPS-BRZ-LH-LL	1"	12	25	\$90
BV1.25-IPS-BRZ-LH-LL	1 1/4"	6	18	\$108
BV1.50-IPS-BRZ-LH-LL	1 1/2"	6	24	\$147
BV2.00-IPS-BRZ-LH-LL	2"	6	28	\$241

"MIFAB commercial plumbing products have you covered so nothing you need slips through your hands."

- Richard Aliff, Plumbing Engineer, BNK Engineering, Raleigh, NC

CALIFORNIA PROPOSITION 65 WARNING. This product contains chemicals known to the State of California to cause cancer and birth defects or other reproductive harm.

Design and dimensions are subject to modification. Prices do not include applicable taxes.

Visit www.beecobackflow.com for the most recent product information.

BEECO, Inc., 1321 West 119th Street, Chicago, Illinois 60643-5109, USA

Toll Free: 1-800-465-2736, Fax: 1-773-341-3049
sales@mifab.com • Canada Toll Free: 1-800-387-3880

All sales subject to BEECO's Terms and Warranties. Please refer to page no. 66.



Distributed by: **MIFAB**

WORKING PRESSURE: 250 psi
BODY & COVER: Epoxy Coated Ductile Iron
ELASTOMERS: EPDM
TUBING/FITTINGS: Reinforced Nylon w/Brass Fittings
CONTROL PILOT(S): Bronze / Brass

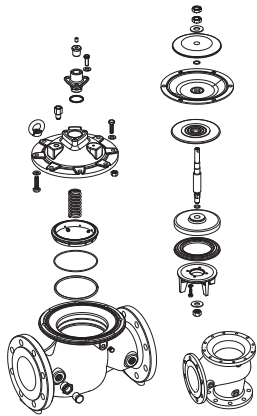

ACV4.00-HF-BASIC (ILLUSTRATED)
 FOR SPEC. SHEETS GO TO
www.beecobackflow.com



PRV.50-C-RUBBER-KIT (ILLUSTRATED)
 FOR SPEC. SHEETS GO TO
www.beecobackflow.com



PRV1.00-RUBBER-KIT (ILLUSTRATED)
 FOR SPEC. SHEETS GO TO
www.beecobackflow.com



PVB1.00-RK (ILLUSTRATED)
 FOR SPEC. SHEETS GO TO
www.beecobackflow.com

ACV - AUTOMATIC CONTROL VALVE REPAIR KITS

Model Number	Size	Qty. per Carton	Weight per Carton (Lbs.)	List Price (Each)
ACV2.00-REPAIR-KIT	2"	1	1	\$396
ACV2.50-REPAIR-KIT	2 1/2"	1	2	\$405
ACV3.00-REPAIR-KIT	3"	1	3	\$414
ACV4.00-REPAIR-KIT	4"	1	4	\$414
ACV6.00-REPAIR-KIT	6"	1	5	\$466
ACV8.00-REPAIR-KIT	8"	1	6	\$1,553
ACV10.00-REPAIR-KIT	10"	1	7	\$3,331

For Reduced Port Valves Order One Full Pipe Size Smaller Than Your Full Port Valve.

FPVB (REPAIR KITS FOR FPVB PRESSURE VACUUM BREAKERS)

REPAIR KITS FOR FPVB PRESSURE VACUUM BREAKERS

Model Number	Size	Qty. per Carton	Weight per Carton (Lbs.)	List Price (Each)
FPVB1.00-INTERNAL-KIT	1/2" THRU 1"	1	1	\$15
FPVB1.00-BONNET-KIT	1/2" THRU 1"	1	1	\$25

PRV - PRESSURE REDUCING VALVE REPAIR KITS

RUBBER REPAIR KITS FOR COMPACT MODEL PRV

Model Number	Size	Qty. per Carton	Weight per Carton (Lbs.)	List Price (Each)
PRV.50-C-RUBBER-KIT	1/2"	1	1	\$40
PRV.75-C-RUBBER-KIT	3/4"	1	1	\$40
PRV1.00-C-RUBBER-KIT	1"	1	1	\$40
PRV1.25-C-RUBBER-KIT	1 1/4"	1	1	\$54
PRV1.50-C-RUBBER-KIT	1 1/2"	1	1	\$54
PRV2.00-C-RUBBER-KIT	2"	1	1	\$54

RUBBER REPAIR KITS FOR FULL PATTERN MODEL PRV

Model Number	Size	Qty. per Carton	Weight per Carton (Lbs.)	List Price (Each)
PRV.50-F-RUBBER-KIT	1/2"	1	1	\$40
PRV.75-F-RUBBER-KIT	3/4"	1	1	\$40
PRV1.00-F-RUBBER-KIT	1"	1	1	\$40

REPAIR KITS FOR PRESSURE VACUUM BREAKERS

Model Number	Size	Qty. per Carton	Weight per Carton (Lbs.)	List Price (Each)
PVB1.00-RK	1/2" - 1"	1	2	\$40
PVB2.00-RK	1 1/4" - 2"	1	3	\$54

"BEECO® has in stock in local inventory easy to get it, easy to install because come with double union"

- Terry Zhang, L.C. Plumbing & Electrical Supply

CALIFORNIA PROPOSITION 65 WARNING. This product contains chemicals known to the State of California to cause cancer and birth defects or other reproductive harm.

FDC-RK (DC BACKFLOW PREVENTERS, REPAIR KITS)

ALL RUBBER SEATS AND SEALS				
Model Number	Size	Qty. per Carton	Weight per Carton (Lbs.)	List Price (Each)
FDC.75-RUBBER-KIT	1/2", 3/4"	1	1	\$31
FDC1.00-RUBBER-KIT	1"	1	1	\$38
FDC1.50-RUBBER-KIT	1 1/4", 1 1/2"	1	1	\$46
FDC2.00-RUBBER-KIT	2"	1	1	\$59
FDC4.00-RUBBER-KIT	2 1/2", 3", 4"	1	1	\$271
FDC6.00-RUBBER-KIT	6"	1	1	\$327
FDC10.00-RUBBER-KIT	8", 10"	1	1	\$483

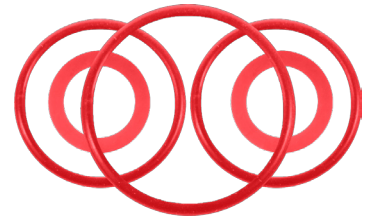

FDC2.00-RUBBER-KIT (ILLUSTRATED)

REPLACEMENT CHECK				
Model Number	Size	Qty. per Carton	Weight per Carton (Lbs.)	List Price (Each)
FDC.75-CHECK	1/2", 3/4"	1	1	\$35
FDC1.00-CHECK	1"	1	1	\$78
FDC1.50-CHECK	1 1/4", 1 1/2"	1	1	\$142
FDC2.00-CHECK	2"	1	1	\$157
FDC4.00-CHECK	2 1/2", 3", 4"	1	1	\$740
FDC6.00-CHECK	6"	1	1	\$1,201
FDC10.00-CHECK	8", 10"	1	1	\$1,860



FDC2.00-CHECK (ILLUSTRATED)

CHECK SPACERS FOR 1/2" - 2" BACKFLOW PREVENTERS				
Model Number	Size	Qty. per Carton	Weight per Carton (Lbs.)	List Price (Each)
FDC-RP.75-CK-SPACER	1/2", 3/4"	1	1	\$29
FDC-RP1.00-CK-SPACER	1"	1	1	\$35
FDC1.50-CK-SPACER	1 1/4", 1 1/2"	1	1	\$40
FDC-RP2.00-CK-SPACER	2"	1	1	\$43



FDC-RP2.00-CK-SPACER (ILLUSTRATED)

FRP-RK (RPZ BACKFLOW PREVENTERS, REPAIR KITS)

ALL RUBBER SEATS AND SEALS EXCEPT RELIEF VALVE				
Model Number	Size	Qty. per Carton	Weight per Carton (Lbs.)	List Price (Each)
FRP.75-RUBBER-KIT	1/2", 3/4"	1	1	\$29
FRP1.00-RUBBER-KIT	1"	1	1	\$35
FRP2.00-RUBBER-KIT	1 1/4", 1 1/2", 2"	1	1	\$43
FRP4.00-RUBBER-KIT	2 1/2", 3", 4"	1	1	\$261
FRP6.00-RUBBER-KIT	6"	1	1	\$315
FRP10.00-RUBBER-KIT	8", 10"	1	1	\$464

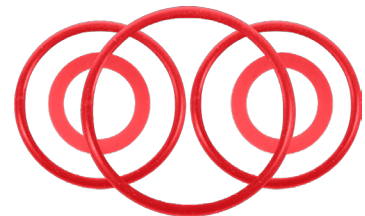

FRP2.00-RUBBER-KIT (ILLUSTRATED)

CALIFORNIA PROPOSITION 65 WARNING. This product contains chemicals known to the State of California to cause cancer and birth defects or other reproductive harm.

ALL RUBBER SEATS, SEALS AND RELIEF VALVE PARTS

**FRP1.00-RV-KIT
(ILLUSTRATED)**

**FRP2.00-CHECK-1ST
(ILLUSTRATED)**

FRP4.00-CHECK-2ND (ILLUSTRATED)
ALL RUBBER SEATS, SEALS AND RELIEF VALVE ONLY

Model Number	Size	Qty. per Carton	Weight per Carton (Lbs.)	List Price (Each)
FRP1.00-RV-KIT	1/2", 3/4", 1"	1	1	\$56
FRP2.00-RV-KIT	1 1/4", 1 1/2", 2"	1	1	\$66
FRP6.00-RV-KIT	2 1/2", 3", 4", 6"	1	1	\$301
FRP10.00-RV-KIT	8", 10"	1	1	\$464

REPLACEMENT FOR FIRST CHECK

Model Number	Size	Qty. per Carton	Weight per Carton (Lbs.)	List Price (Each)
FRP.75-CHECK-1ST	1/2", 3/4"	1	1	\$40
FRP1.00-CHECK-1ST	1"	1	1	\$76
FRP2.00-CHECK-1ST	1 1/4", 1 1/2", 2"	1	1	\$150
FRP4.00-CHECK-1ST	2 1/2", 3", 4"	1	3	\$758
FRP6.00-CHECK-1ST	6"	1	5	\$1,308
FRP10.00-CHECK-1ST	8", 10"	1	7	\$1,861

PLASTIC REPLACEMENT PARTS FOR RELIEF VALVES

Model Number	Size	Weight per Carton (Lbs.)	List Price (Each)
FRP1.00-RV-PARTS	1/2", 3/4", 1"	1	\$55
FRP2.00-RV-PARTS	1 1/4", 1 1/2", 2"	1	\$65
FRP6.00-RV-PARTS	2 1/2", 3", 4", 6"	2	\$96
FRP10.00-RV-PARTS	8", 10"	3	\$165

REPLACEMENT BACKFLOW PREVENTER CHECKS
REPLACEMENT FOR SECOND CHECK

Model Number	Size	Qty. per Carton	Weight per Carton (Lbs.)	List Price (Each)
FRP.75-CHECK-2ND	1/2", 3/4"	1	1	\$35
FRP1.00-CHECK-2ND	1"	1	1	\$78
FRP2.00-CHECK-2ND	1 1/4", 1 1/2", 2"	1	1	\$142
FRP4.00-CHECK-2ND	2 1/2", 3", 4"	1	3	\$740
FRP6.00-CHECK-2ND	6"	1	5	\$1,201
FRP10.00-CHECK-2ND	8", 10"	1	7	\$1,860

"The BEECO® Backflow is very easy to service and the repair parts are very reasonably priced."

- Frank Paulette, Correct Mechanical

CALIFORNIA PROPOSITION 65 WARNING. This product contains chemicals known to the State of California to cause cancer and birth defects or other reproductive harm.

FDC / FRP ASSEMBLIES

FIRST CHECK RETAINER CLIPS

Model Number	Size	Qty. per Carton	Weight per Carton (Lbs.)	List Price (Each)
FDC-400-RET-SPACER	2 1/2"-4"	1	1	POA
FDC-400-SPRG-RET	3 1/2"-4"	1	1	POA
FDC-600-RET-SPACER	6"	1	1	POA
FDC-600-SPRG-RET	6"	1	1	POA
FDC-1000-RET-SPACER	8"-10"	1	1	POA
FDC-1000-SPRG-RET	8"-10"	1	1	POA

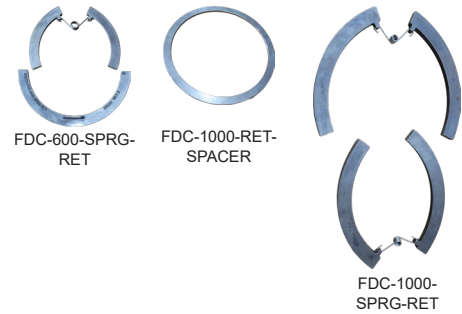

SECOND CHECK RETAINER CLIPS

Model Number	Size	Qty. per Carton	Weight per Carton (Lbs.)	List Price (Each)
FDC-400-RET-CLIP	2 1/2"-4"	1	1	POA
FDC-600-RET-CLIP	6"	1	1	POA
FDC-1000-RET-CLIP	8"-10"	1	1	POA

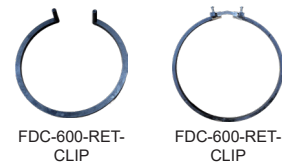

OLD HERSEY BEECO® REPAIR KITS

RUBBER REPAIR KITS. OLD STYLE HERSEY BEECO® BACKFLOW PREVENTERS

RUBBER REPAIR KIT, FDC MODEL (2006 AND PRIOR)

Model Number	Size	Qty. per Carton	Weight per Carton (Lbs.)	List Price (Each)
65671-FDC-BASIC-KIT	3/4"&1"	1	1	\$148
65672-FDC-BASIC-KIT	1 1/2"	1	1	\$217
65673-FDC-BASIC-KIT	2"	1	1	\$235

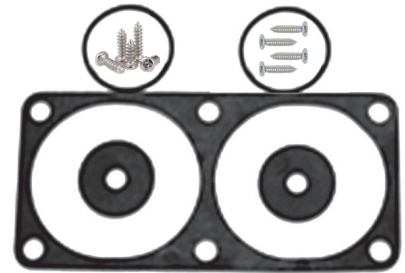

65673-FDC-BASIC-KIT(ILLUSTRATED)

RUBBER REPAIR KIT, FDC MODEL 2 AND DDC II MODEL (2006 AND PRIOR)

Model Number	Size	Qty. per Carton	Weight per Carton (Lbs.)	List Price (Each)
63351-FDC-RUB-KIT	3"	1	1	\$502
63451-FDC-RUB-KIT	4"	1	1	\$687
63651-FDC-RUB-KIT	6"	1	1	\$810
63851-FDC-RUB-KIT	8"	1	1	\$1,550
63951-FDC-RUB-KIT	10"	1	1	\$4,463

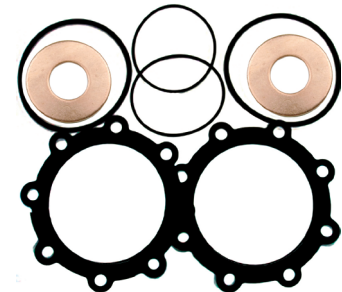

63351-FDC-RUB-KIT (ILLUSTRATED)

RUBBER REPAIR KIT, FRP II (2006 AND PRIOR)

Model Number	Size	Qty. per Carton	Weight per Carton (Lbs.)	List Price (Each)
65668-FRP-II-RUB-KIT	3/4", 1"	1	1	\$170
65669-FRP-II-RUB-KIT	1 1/4", 1 1/2"	1	1	\$230
65670-FRP-II-RUB-KIT	2"	1	1	\$248



65668-FRP-II-RUB-KIT(ILLUSTRATED)

CALIFORNIA PROPOSITION 65 WARNING. This product contains chemicals known to the State of California to cause cancer and birth defects or other reproductive harm.

63543-CI-6CM-RUB-KIT(ILLUSTRATED)

RUBBER REPAIR KIT, FRP #6CM CAST IRON DESIGN (2006 AND PRIOR)				
Model Number	Size	Qty. per Carton	Weight per Carton (Lbs.)	List Price (Each)
63543-CI-6CM-RUB-KIT	2 1/2"	1	1	\$844
63350-CI-6CM-RUB-KIT	3"	1	1	\$876
63450-CI-6CM-RUB-KIT	4"	1	1	\$1,037
63650-CI-6CM-RUB-KIT	6"	1	1	\$1,424
63850-CI-6CM-RUB-KIT	8"	1	1	\$2,053
63950-CI-6CM-RUB-KIT	10"	1	1	\$4,907

63550-BRZ-6CM-KIT(ILLUSTRATED)

RUBBER REPAIR KIT, FRP #6CM BRONZE DESIGN (2006 AND PRIOR)				
Model Number	Size	Qty. per Carton	Weight per Carton (Lbs.)	List Price (Each)
63550-BRZ-6CM-KIT	2 1/2"	1	1	\$816
63343-BRZ-6CM-KIT	3"	1	1	\$833
63443-BRZ-6CM-KIT	4"	1	1	\$888
63643-BRZ-6CM-KIT	6"	1	1	\$1,388

61231-CI-6C-RUB-KIT(ILLUSTRATED)

RUBBER REPAIR KIT, FRP 6C CAST IRON DESIGN (2006 AND PRIOR)				
Model Number	Size	Qty. per Carton	Weight per Carton (Lbs.)	List Price (Each)
61231-CI-6C-RUB-KIT	6"	1	1	\$1,007
61233-CI-6C-RUB-KIT	8"	1	1	\$2,554
61234-CI-6C-RUB-KIT	10"	1	1	\$3,488

61225-BRZ-6C-RUB-KIT(ILLUSTRATED)

RUBBER REPAIR KIT, FRP 6C BRONZE DESIGN (2006 AND PRIOR)				
Model Number	Size	Qty. per Carton	Weight per Carton (Lbs.)	List Price (Each)
61225-BRZ-6C-RUB-KIT	1"	1	1	\$512
61226-BRZ-6C-RUB-KIT	1 1/2"	1	1	\$554
61227-BRZ-6C-RUB-KIT	2"	1	1	\$608
61228-BRZ-6C-RUB-KIT	2 1/2"	1	1	\$675
61229-BRZ-6C-RUB-KIT	3"	1	1	\$709
61230-BRZ-6C-RUB-KIT	4"	1	1	\$753
61232-BRZ-6C-RUB-KIT	6"	1	1	\$971

CALIFORNIA PROPOSITION 65 WARNING. This product contains chemicals known to the State of California to cause cancer and birth defects or other reproductive harm.

TK SERIES

BACKFLOW PREVENTER TEST KITS

Model Number	DESCRIPTION	Qty. per Carton	Weight per Carton (Lbs.)	List Price (Each)
TK5-BACKFLOW-TEST	Test kit with engineered plastic body, 4.5" round dial, 1.5" round line pressure gauge, with (3) five foot hoses, (9) adapter fittings, laminated test procedures, shoulder strap and plastic carrying case. 0-15 PSID , Error tolerance +/- 0.02 PSID on descending pressure.	1	10	\$ 2,800



TK5-BACKFLOW-TEST (ILLUSTRATED)
FOR SPEC. SHEETS GO TO
www.beecobackflow.com

SPECIFICATION: FIVENEEDLEVALVEFIELD TEST KIT

TYPE: Diaphragm Differential Pressure,

DIFFERENTIAL PRESSURE ACCURACY:
±0.2 P.S.I.D. (Descending),

WORKING PRESSURE: 200 P.S.I.G.

FUNCTION: The BEECO Test Kit is a compact, portable device made for testing backflow prevention assemblies, including Reduced Pressure Zone assemblies, Double Check Valve assemblies, and Pressure Vacuum Breakers.

TEMPERATURE LIMITATIONS:
Maximum 150°F/65°C.

FREEZING TEMPERATURES MUST BE AVOIDED!

BACKFLOW PREVENTER TROUBLE SHOOTING GUIDE

1. Is the discharge time-able?
If the discharge is time-able then follow the next three steps to help narrow your focus on the correct section of the valve. If it is not time-able then the valve is fine and your system has pressure fluctuations.
2. Shut off the downstream shut off valve. If water discharge stops, 2nd check is faulty. Remove the bronze cover above the checks and remove any debris or replace faulty parts.
3. If discharge continues then create a flow equal to or greater than the discharge. If the discharge stops, the 1st check is faulty. Remove the bronze cover above the checks and remove any debris or replace faulty parts.
4. If discharge continues while water is flowing the relief valve is faulty. Remove the relief valve from the body and remove any debris or replace faulty parts.



CALIFORNIA PROPOSITION 65 WARNING. This product contains chemicals known to the State of California to cause cancer and birth defects or other reproductive harm.



Distributed by: **MIFAB**

BEECO-2026

SMALL DIAMETER LEAD FREE BACKFLOW CROSS REFERENCE

BEECO® DC - Small Diameter Lead Free Backflow Cross Reference

MODEL	SIZE	BEECO®	WILKINS			WATTS		FEBCO	APOLLO
		FDC	950XL3	350XL	950XL2/XLT2	LF719	LF007	LF850	4ALF-100
DC	1/2"	FDC.50-QT-LL	N/A	N/A	N/A	1/2" LF719	1/2" LF007QT	1/2" LF850	4ALF103A2F
DC	3/4"	FDC.75-QT-LL	34-950XL3	34-350XL	34-950XLT2	3/4" LF719	3/4" LF007M3QT	3/4" LF850	4ALF104A2F
DC	1"	FDC1.00-QT-LL	1-950XL3	1-350XL	1-950XLT2	1" LF719	1" LF007M1QT	1" LF850	4ALF105A2F
DC	1-1/4"	FDC1.25-QT-LL	114-950XL3	114-350XL	114-950XLT2	1-1/4" LF719	1-1/4" LF007M2QT	1-1/4" LF850	4ALF106A2F
DC	1-1/2"	FDC1.50-QT-LL	112-950XL3	112-350XL	112-950XLT2	1-1/2" LF719	1-1/2" LF007M2QT	1-1/2" LF850	4ALF107A2F
DC	2"	FDC2.00-QT-LL	2-950XL3	2-350XL	2-950XLT2	2" LF719	2" LF007M1QT	2" LF850	4ALF108A2F

BEECO® RP - Small Diameter Low Lead RPZ Backflow Cross Reference

MODEL	SIZE	BEECO®	WILKINS			WATTS		FEBCO		APOLLO
		FRP	975XL3	375XL	975XL2	LF909 OR LF919	LF'009	LF825Y	LF860	4ALF-200
RP	1/2"	FRP.50-QT-LL	12-975XL3	12-375XL	12-975XL2	1/2" LF909QT	1/2" LF009QT	NA	1/2" LF860	4ALF203A2F
RP	3/4"	FRP.75-QT-LL	34-975XL3	34-375XL	34-975XL2	3/4" LF909QT	3/4" LF009M2QT	3/4" LF825Y	3/4" LF860	4ALF204A2F
RP	1"	FRP1.00-QT-LL	1-975XL3	1-375XL	1-975XL2	1" LF909QT	1" LF009M2QT	1" LF825Y	1" LF860	4ALF205A2F
RP	1-1/4"	FRP1.25-QT-LL	114-975XL3	114-375XL	114-975XL2	1-1/4" LF909QT	1-1/4" LF009M2QT	1-1/4" LF825Y	1-1/4" LF860	4ALF206A2F
RP	1-1/2"	FRP1.50-QT-LL	112-975XL3	112-375XL	112-975XL2	1-1/2" LF909QT	1-1/2" LF009M2QT	1-1/2" LF825Y	1-1/2" LF860	4ALF207A2F
RP	2"	FRP2.00-QT-LL	2-975XL3	2-375XL	2-975XL2	2" LF909QT	2" LF009M2QT	2" LF825Y	2" LF860	4ALF208A2F

BEECO® PVB - Pressure Vacuum Breaker Low Lead Backflow Cross Reference

MODEL	SIZE	BEECO®	WILKINS			WATTS	FEBCO	APOLLO
		PVB	720A (no LF)	710	LF800	765 (no LF)	4ALF-500	4ALF-200
PVB	1/2"	PVB.50-QT-LL	12-720A	N/A	1/2" LF800	1/2" 765	4ALF503A2F	4ALF203A2F
PVB	3/4"	PVB.75-QT-LL	34-720A	34-710	3/4" LF800	3/4" 765	4ALF504A2F	4ALF204A2F
PVB	1"	PVB1.00-QT-LL	1-720A	1-710	1" LF800	1" 765	4ALF505A2F	4ALF205A2F
PVB	1-1/4"	PVB1.25-QT-LL	114-720A	N/A	1-1/4" LF800	1-1/4" 765	4ALF506A2F	4ALF206A2F
PVB	1-1/2"	PVB1.50-QT-LL	112-720A	N/A	1-1/2" LF800	1-1/2" 765	4ALF507A2F	4ALF207A2F
PVB	2"	PVB2.00-QT-LL	2-720A	N/A	2" LF800	2" 765	4ALF508A2F	4ALF208A2F

BEECO® - Dual Check Low Lead Backflow Cross Reference

Model	Size	BEECO®	Wilkins	Watts	Cash Acme	Apollo
		DUAL CHECK	700XL	LF7R	BF	4ALF-300
DUC	1/2"	DC.50-NPTX.50-NPT-LL	12UFX12F-700XL	1/2" LF7RU2-2	BF11212	4ALF-3A33A
DUC	3/4"	DC.75-NPTX.75-NPT-LL	34UFX34F-700XL	3/4" LF7RU2-2	BF13434	4ALF-3A44A
DUC	1"	DC1.0-NPTX1.0-NPT-LL	1UFX1F-700XL	1" LF7RU2-2	BF10101	4ALF-3A55A

BEECO® DCAV - Vented Dual Check Backflow Cross Reference

Model	Size	BEECO®	Wilkins	Watts	Cash Acme	Apollo
		DCAV	760	9D	BFP	4ALF-400
DCAP	1/2"	DCAV.50-NPT	12-760	1/2" 9DM3	BFP11212	4ALF-4A33A
DCAP	3/4"	DCAV.75-NPT	34-760	3/4" 9DM2	BFP13434	4ALF-4A44A

CALIFORNIA PROPOSITION 65 WARNING. This product contains chemicals known to the State of California to cause cancer and birth defects or other reproductive harm.

BEECO® LARGE DIAMETER LEAD FREE BACKFLOW CROSS REFERENCE

STAINLESS STEEL

MODEL	SIZE	SHUT OFF VALVE	BEECO® BARRACUDA	WILKINS	WATTS	APOLLO
		NRS	FDC SS	350A	774	4A
DC	2-1/2"	NON-RISING STEM	FDC2.50-SS-NRS	212-350AST	2-1/2" 774-NRS	4ALF10902
DC	3"	NON-RISING STEM	FDC3.00-SS-NRS	3-350AST	3" 774-NRS	4ALF10002
DC	4"	NON-RISING STEM	FDC4.00-SS-NRS	4-350AST	4" 774-NRS	4ALF10A02
DC	6"	NON-RISING STEM	FDC6.00-SSX-NRS	6-350AST	6" 774-NRS	4ALF10C02
DC	8"	NON-RISING STEM	FDC8.00-SS-NRS	8-350AST	8" 774-NRS	4ALF10E02
		OSY	FDC SS	350	774	4A
DC	2-1/2"	OUTSIDE STEM & YOKE	FDC2.50-SS-OSY-UL	212-350ASTOSY	2-1/2" 774-OSY	4ALF10903
DC	3"	OUTSIDE STEM & YOKE	FDC3.00-SS-OSY-UL	3-350ASTOSY	3" 774-OSY	4ALF10003
DC	4"	OUTSIDE STEM & YOKE	FDC4.00-SS-OSY-UL	4-350ASTOSY	4" 774-OSY	4ALF10A03
DC	6"	OUTSIDE STEM & YOKE	FDC6.00-SSX-OSY-UL	6-350ASTOSY	6" 774-OSY	4ALF10C03
DC	8"	OUTSIDE STEM & YOKE	FDC8.00-SS-OSY-UL	8-350ASTOSY	8" 774-OSY	4ALF10E03
		NRS	FDC SS	375	994	4A
RP	2-1/2"	NON-RISING STEM	FRP2.50-SS-NRS	212-375AST	2-1/2" 994-NRS	4ALF20902
RP	3"	NON-RISING STEM	FRP3.00-SS-NRS	3-375AST	3" 994-NRS	4ALF20002
RP	4"	NON-RISING STEM	FRP4.00-SS-NRS	4-375AST	4" 994-NRS	4ALF20A02
RP	6"	NON-RISING STEM	FRP6.00-SSX-NRS	6-375AST	6" 994-NRS	4ALF20C02
RP	8"	NON-RISING STEM	FRP8.00-SS-NRS	8-375AST	8" 994-NRS	4ALF20E02
		OSY	FDC SS	375	994	4A
RP	2-1/2"	OUTSIDE STEM & YOKE	FRP2.50-SS-OSY-UL	212-375ASTOSY	2-1/2" 994-OSY	4ALF20903
RP	3"	OUTSIDE STEM & YOKE	FRP3.00-SS-OSY-UL	3-375ASTOSY	3" 994-OSY	4ALF20003
RP	4"	OUTSIDE STEM & YOKE	FRP4.00-SS-OSY-UL	4-375ASTOSY	4" 994-OSY	4ALF20A03
RP	6"	OUTSIDE STEM & YOKE	FRP6.00-SSX-OSY-UL	6-375ASTOSY	6" 994-OSY	4ALF20C03
RP	8"	OUTSIDE STEM & YOKE	FRP8.00-SS-OSY-UL	8-375ASTOSY	8" 994-OSY	4ALF20E03

CALIFORNIA PROPOSITION 65 WARNING. This product contains chemicals known to the State of California to cause cancer and birth defects or other reproductive harm.



Distributed by: **MIFAB**

BEECO-2026

BEECO® LARGE DIAMETER LEAD FREE BACKFLOW CROSS REFERENCE

EPOXY COATED DUCTILE IRON

MODEL	SIZE	SHUT OFF VALVE	BEECO®	WILKINS	WATTS	FEBCO
		NRS	FDC	350A	LF709	LF709
DC	2-1/2"	NON-RISING STEM	FDC2.50-NRS	212-350A	2-1/2" LF709-NRS	2-1/2" LF850-NRS
DC	3"	NON-RISING STEM	FDC3.00-NRS	3-350A	3" LF709-NRS	3" LF850-NRS
DC	4"	NON-RISING STEM	FDC4.00-NRS	4-350A	4" LF709-NRS	4" LF850-NRS
DC	6"	NON-RISING STEM	FDC6.00-NRS	6-350A	6" LF709-NRS	6" LF850-NRS
DC	8"	NON-RISING STEM	FDC8.00-NRS	8-350A	8" LF709-NRS	8" LF850-NRS
DC	10"	NON-RISING STEM	FDC10.00-NRS	10-350A	10" LF709-NRS	10" LF850-NRS
		OSY	FDC	350	LF709	LF850
DC	2-1/2"	OUTSIDE STEM & YOKE	FDC2.50-OSY-UL	212-350AOSY	2-1/2" LF709-OSY	2-1/2" LF850-OSY
DC	3"	OUTSIDE STEM & YOKE	FDC3.00-OSY-UL	3-350AOSY	23" LF709-OSY	23" LF850-OSY
DC	4"	OUTSIDE STEM & YOKE	FDC4.00-OSY-UL	4-350AOSY	4" LF709-OSY	4" LF850-OSY
DC	6"	OUTSIDE STEM & YOKE	FDC6.00-OSY-UL	6-350AOSY	6" LF709-OSY	6" LF850-OSY
DC	8"	OUTSIDE STEM & YOKE	FDC8.00-OSY-UL	8-350AOSY	8" LF709-OSY	8" LF850-OSY
DC	10"	OUTSIDE STEM & YOKE	FDC10.00-OSY-UL	10-350AOSY	10" LF709-OSY	10" LF850-OSY
		NRS	FRP	375A	LF909	LF860
RP	2-1/2"	NON-RISING STEM	FRP2.50-NRS	212-375A	2-1/2" LF909-NRS	2-1/2" LF860-NRS
RP	3"	NON-RISING STEM	FRP3.00-NRS	3-375A	3" LF909-NRS	3" LF860-NRS
RP	4"	NON-RISING STEM	FRP4.00-NRS	4-375A	4" LF909-NRS	4" LF860-NRS
RP	6"	NON-RISING STEM	FRP6.00-NRS	6-375A	6" LF909-NRS	6" LF860-NRS
RP	8"	NON-RISING STEM	FRP8.00-NRS	8-375A	8" LF909-NRS	8" LF860-NRS
RP	10"	NON-RISING STEM	FRP10.00-NRS	10-375A	10" LF909-NRS	10" LF860-NRS
		OSY	FRP	375	LF909	LF860
RP	2-1/2"	OUTSIDE STEM & YOKE	FRP2.50-OSY-UL	212-375AOSY	2-1/2" LF909-OSY	2-1/2" LF860-OSY
RP	3"	OUTSIDE STEM & YOKE	FRP3.00-OSY-UL	3-375AOSY	3" LF909-OSY	3" LF860-OSY
RP	4"	OUTSIDE STEM & YOKE	FRP4.00-OSY-UL	4-375AOSY	4" LF909-OSY	4" LF860-OSY
RP	6"	OUTSIDE STEM & YOKE	FRP6.00-OSY-UL	6-375AOSY	6" LF909-OSY	6" LF860-OSY
RP	8"	OUTSIDE STEM & YOKE	FRP8.00-OSY-UL	8-375AOSY	8" LF909-OSY	8" LF860-OSY
RP	10"	OUTSIDE STEM & YOKE	FRP10.00-OSY-UL	10-375AOSY	10" LF909-OSY	10" LF860-OSY

EPOXY COATED DUCTILE IRON

MODEL	SIZE	STYLE	BEECO®	WILKINS	WATTS	WATTS	FEBCO	APOLLO
			FDC	350ADA	LF774 DCDA	LF709 DCDA	LF856	4A
DC	2-1/2"	DCDA	FDC2.50-OSY-DCDA	212-350ADA	2-1/2" LF709DCDA	2-1/2" LF709DCDA	2-1/2" LF856	4ALF609E3
DC	3"	DCDA	FDC3.00-OSY-DCDA	3-350ADA	23" LF709DCDA	23" LF709DCDA	23" LF856	4ALF600E3
DC	4"	DCDA	FDC4.00-OSY-DCDA	4-350ADA	4" LF709DCDA	4" LF709DCDA	4" LF856	4ALF60AE3
DC	6"	DCDA	FDC6.00-OSY-DCDA	6-350ADA	6" LF709DCDA	6" LF709DCDA	6" LF856	4ALF60CE3
DC	8"	DCDA	FDC8.00-OSY-DCDA	8-350ADA	8" LF709DCDA	8" LF709DCDA	8" LF856	4ALF60EE3
DC	10"	DCDA	FDC10.00-OSY-DCDA	10-350ADA	10" LF709DCDA	10" LF709DCDA	10" LF856	4ALF60GE3
			FRP	375ADA	LF994 RPDA	LF909 RPDA	LF866	4A
RP	2-1/2"	RPDA	FRP2.50-OSY-RPDA	212-375ADA	2-1/2" LF909RPDA	2-1/2" LF909RPDA	2-1/2" LF866	4ALF709E3
RP	3"	RPDA	FRP3.00-OSY-RPDA	3-375ADA	3" LF909RPDA	3" LF909RPDA	3" LF866	4ALF700E3
RP	4"	RPDA	FRP4.00-OSY-RPDA	4-375ADA	4" LF909RPDA	4" LF909RPDA	4" LF866	4ALF70AE3
RP	6"	RPDA	FRP6.00-OSY-RPDA	6-375ADA	6" LF909RPDA	6" LF909RPDA	6" LF866	4ALF70CE3
RP	8"	RPDA	FRP8.00-OSY-RPDA	8-375ADA	8" LF909RPDA	8" LF909RPDA	8" LF866	4ALF70EE3
RP	10"	RPDA	FRP10.00-OSY-RPDA	10-375ADA	10" LF909RPDA	10" LF909RPDA	10" LF866	4ALF70GE3

CALIFORNIA PROPOSITION 65 WARNING. This product contains chemicals known to the State of California to cause cancer and birth defects or other reproductive harm.

BEECO® PRESSURE REDUCING VALVE CROSS REFERENCE

MODEL	SIZE	BEECO®	WILKINS	WATTS	CASH ACME	APOLLO	
		PRV-C	NR3XL	70XL	N45	765 (NO LF)	36ELF
PRV-C	1/2"	PRV.50-DU-IPS-C-LL	12-NR3XLDU	N/A	1/2" LFN45BDU-M#	1/2" EB45DU	36ELF-123-0T
PRV-C	3/4"	PRV.75-DU-IPS-C-LL	34-NR3XLDU	34-70XLDU	3/4" LFN45BDU-M#	3/4" EB45DU	36ELF-124-0T
PRV-C	1"	PRV1.00-DU-IPS-C-LL	1-NR3XLDU	1-70XLDU	1" LFN45BDU-M#	1" EB45DU	36ELF-125-0T
PRV-C	1-1/4"	PRV1.25-DU-IPS-C-LL	114-NR3XLDU	N/A	1-1/4" LFN45BDU-M#	1-1/4" EB45DU	36LF-406-01
PRV-C	1-1/2"	PRV1.50-DU-IPS-C-LL	112-NR3XLDU	N/A	1-1/2" LFN45BDU-M#	1-1/2" EB45DU	36LF-407-01
PRV-C	2"	PRV2.00-DU-IPS-C-LL	2-NR3XLDU	N/A	2" LFN45BDU-M#	2" EB45DU	36LF-408-01

DU = Double Union (shown in Cross Ref) all others • SU = Single Union • SWT = Sweat • UPO Expansion • PEX =

MODEL	SIZE	BEECO®	WILKINS	WATTS	CASH ACME	APOLLO
		PRV-F	600XL3	LF25AUB	765 (NO LF)	36ELF
PRV-F	3/4"	PRV.75-SU-IPS-F-LL	34-600XL3	3/4" LFLF25AUB-M#	3/4" E3	36LF-104-01
PRV-F	1"	PRV1.00-SU-IPS-F-LL	1-600XL3	1" LFLF25AUB-M#	1" E3	36LF-105-01
PRV-F	1-1/4"	PRV1.25-SU-IPS-F-LL	114-600XL3	1-1/4" LFLF25AUB-M#	1-1/4" E3	36LF-106-01
PRV-F	1-1/2"	PRV1.50-SU-IPS-F-LL	112-600XL3	1-1/2" LFLF25AUB-M#	1-1/2" E3	36LF-107-01
PRV-F	2"	PRV2.00-SU-IPS-F-LL	2-600XL3	2" LFLF25AUB-M#	2" E3	36LF-108-01

Directly replaces LF25AUB lay length and union nut threads

BEECO® ACV PILOT OPERATED PRESSURE REDUCING VALVE CROSS REFERENCE

MODEL	SIZE	BEECO®	WILKINS	WATTS	CLA-VAL	SINGER	BERMAD	OCV
		ACV	ZW209	LF115F OR M	90-01	106-PR	720	127-3
ACV-PR	2"	ACV2.00-HF-T-PR	2-ZW209	2" LFF115	90-01	2" 106-PR	2" 720	2" 127-3
ACV-PR	2-1/2"	ACV2.50-HF-T-PR	212-ZW209	2 1/2" LFF115	90-01	2-1/2" 106-PR	2-1/2" 720	2-1/2" 127-3
ACV-PR	3"	ACV3.00-HF-T-PR	3-ZW209	3" LFF115	90-01	3" 106-PR	3" 720	3" 127-3
ACV-PR	4"	ACV4.00-HF-T-PR	4-ZW209	4" LFF115	90-01	4" 106-PR	4" 720	4" 127-3
ACV-PR	6"	ACV6.00-HF-T-PR	6-ZW209	6" LFF115	90-01	6" 106-PR	6" 720	6" 127-3
ACV-PR	8"	ACV8.00-HF-T-PR	8-ZW209	8" LFF115	90-01	8" 106-PR	8" 720	8" 127-3

BEECO® ACV Pilot Operated Valve Cross Reference

MODEL	SIZE	BEECO®	WILKINS	WATTS (F OR M MODEL)	CLA-VAL	SINGER	BERMAD	OCV
PRESSURE SUSTAINING								
ACV		ACV#.#-HF-T-PS	ZW205	LFF116	50-01	106-RPS	730	108-2
FLOAT VALVE								
ACV		ACV#.#-HF-T-FL	ZW204	110-14	124-01	106-F	750-60	8000
ALTITUDE CONTROL								
ACV		ACV#.#-HF-T-ALT	ZW221	127-1	210-01	106A-TYPEII	780-AX	3331
BI-LEVEL ALTITUDE CONTROL								
ACV		ACV#.#-HF-T-ALT-B	ZW222	127-2	210-2	106A-TYPEI	780-70-AX	3333

Part numbers match same format as pressure reducing valve section

CALIFORNIA PROPOSITION 65 WARNING. This product contains chemicals known to the State of California to cause cancer and birth defects or other reproductive harm.

ABBREVIATIONS

BEECO® PART NUMBERS. FIRST SET OF LETTERS ABBREVIATION FOR VALVE FOLLOWED BY PIPE SIZE .75 = 3/4" 6 = 6" FOLLOWED BY THE FOLLOWING MAJOR FEATURES.

ACV (AUTOMATIC CONTROL VALVES)

A Angle body design
 AL Altitude control valve (1 way flow)
 AL-BD ... Altitude control valve (2 way flow)
 BC Pump control valve
 CV Check valve or check feature
 DW Deep well pump control valve
 EC Electric control (regulating) valve
 EL Electric (on/off) valve or feature
 EL-RFP. Electric flood protection shut-down valve
 FE Excess flow shut-off valve
 FLDI1 Level control (on-off) valve or feature
 FLLEL Level control (electric on-off) valve
 FR Flow rate control valve
 HF High flow
 HP High pressure 300# valve
 PI Position indicator
 PR Pressure reducing
 PREL Pressure reducing / electric (on-off)
 PS Pressure sustaining
 PSDI Differential sustaining valve or feature
 PSEL Pressure sustaining / electric (on-off)
 PSR Pressure sustaining/relief valve or feature
 Q Quick closing feature
 QR Quick relief valve or feature
 REEL Electric surge anticipator valve
 SSV High pressure safety shut-down valve
 UL Underwriters laboratory approved

PRV (PRESSURE REDUCING VALVES)

C Compact model
 CPVC Plastic connections
 DU Double unions
 F Full model (separate strainer cavity)
 IPS Iron Pipe Size
 JK Jumper kit
 LL Low lead (AB 1953 compliant)
 LP Low Pressure
 MC Metal Cage
 PEX Pex connections
 Press Pro Press
 SU Single union
 SWT Copper sweat connections
 UK Union kit
 UPO Uponor

FDC and FRP (BACKFLOW PREVENTERS)

BA Buy America
 DCDA Double check detector assembly
 G Grooved end connections
 LF Less fittings (no ball valves attached)
 LH Locking handles on ball valves
 LL Low lead (AB 1953 compliant)
 NRS Non rising stem gate valve
 OSY Outside stem and yoke gate valve
 QT Quarter turn ball valves as shutoffs
 RPDA Reduced pressure detector assembly
 S Strainer attached
 SH Stainless handles on ball valves

PVB (PRESSURE VACUUM BREAKERS)

LL Low lead (AB 1953 compliant)
 QT Quarter turn ball valves as shutoffs

DC (DOUBLE CHECK (IN LINE))

FWM Female water meter
 LL Low lead
 NPT National Pipe Taper
 SWT Copper sweat connections

AG (AIR GAP)

AG Air Gap

GV (GATE VALVES)

FM Factory Mutual approved
 FXF Flanged by flanged
 FXG Flanged by grooved
 GXG Grooved by grooved
 MJ Mechanical joint
 NRS Non rising stem gate valve
 OSY Outside stem and yoke gate valve
 UL Underwriters laboratory approved

HVB (HOSE VACUUM BREAKERS)

CP Chrome plated finish
 LL Low lead
 RB Rough brass finish

DU (DIELECTRIC UNIONS)

IPS Iron Pipe Size
 LL Low lead
 SWT Copper sweat connections

EPV (ECCENTRIC PLUG VALVES)

FLG Flanged (ANSI 150)
 MJ Mechanical joint

STR (STRAINERS)

BRZ Bronze material (C84400)
 FLG Flanged
 IPS Iron Pipe Size
 LL Low lead
 PC Epoxy coated
 SWT Copper sweat connections

BV (BALL VALVES)

BRZ Bronze material (C84400)
 IPS Iron Pipe Size
 LH Locking handles on ball valves
 LL Low lead (AB 1953 compliant)
 SH Stainless handles on ball valves
 SWT Copper sweat fitting

AV (AIR VENTS)

FL Flanged (ANSI 150)
 HP High pressure (ANSI 300)
 K Air & vacuum
 KA Combination air release and air & vacuum
 MH Full port
 MS Reduced port
 P Plastic
 SA Surge arresting feature
 SS Stainless steel
 TH IPS threaded
 WP Waste water

CALIFORNIA PROPOSITION 65 WARNING. This product contains chemicals known to the State of California to cause cancer and birth defects or other reproductive harm.

WHOLESALE DISCOUNT: Contact BEECO® or your local representative for your applicable discount structure.

FREIGHT ALLOWANCE: Ex Works, BEECO®'s Chicago, Illinois Factory or Manufacturer Representative's warehouse with full motor freight allowed on shipments of \$3,500 Net or more, within the continental U.S.A. or Canada, except Alaska, Hawaii and Puerto Rico. BEECO® reserves the right to choose the carrier and route of shipment. Alaska: Ex Works, Seattle, WA. Hawaii: Freight allowed on shipments of \$3,500 or more only when shipped from West Coast, U.S. Puerto Rico: Ex Works, Miami, Florida. There is no allowance for United Parcel Service, Federal Express or Shipment by air service. Full motor freight is allowed on shipments of \$3,500 Net or more, within the continental U.S.A. and Canada for any combination of BEECO®, Counterline, No Hub Coupling, Trench Drain, Access Door and Trap Seal Primer products. Shipping dates are estimates and time of delivery is not the essence of the sale of the contract. Therefore, under no circumstances will BEECO® have any responsibility on account of any delays in manufacture, transportation, or otherwise. Additional freight services such as construction site delivery, lift gate delivery service, re-consigned freight or notification charges, are not included in full freight allowance terms, and will result in additional freight charges.

QUOTATION TERMS: List Price and discount protected for 30 days from date issued by BEECO®. Orders received within this period must be released for shipment within 30 days from date of purchase order, otherwise, prices will be those that are in effect at the time of shipment.

PAYMENT TERMS: Terms of payment are Net 30 days from the date of the invoice. All pricing in United States currency unless sold in Canada in which case Canadian dollars is the currency used. The Buyer shall pay all sales, consumers, and / or any other applicable taxes. Past due accounts will be subject to a 2% per month service charge from the date of the invoice. If any proceedings be instructed by or against Buyer under any bankruptcy or insolvency law, or if Buyer shall fail to make timely payment on this or any other order, or if, in MIFAB's judgment, Buyer's financial situation justifies such action, BEECO® may, at its election, require payment in advance or cancel the order as to any unshipped item and require payment of its reasonable cancellation charges. If Buyer delays completion of manufacture, BEECO® may elect to require payment according to percentage of completion. Equipment held for Buyer shall be at Buyer's risk and expense. In all cases, regardless of partial payment, title to the Products shall remain with BEECO® until payment for the Products (including any notes given therefore) has been made in full. Should legal action be necessary to enforce payment of an unpaid invoice, the Buyer will assume full responsibility for any court costs and reasonable attorney fees. All orders subject to credit check and approval prior to shipment. Confirmed irrevocable letter of credit or cash in advance of shipment is required for accounts without an established line of credit. Minimum invoice amount is \$100. BEECO® reserves the right to apply a minimum order charge to equal \$100. BEECO®'s Accounting Department must be notified of potential pricing errors within 30 days of the invoice date. Any terms and conditions stated on Buyer's orders which are inconsistent with MIFAB's quotation and Terms and Warranties shall be of no effect.

RETURNED GOODS RESTOCKING CHARGE: Standard product may be returned within a one year period only with written permission from BEECO®. All products in catalog are not considered Standard. Standard product to be determined by BEECO®. Returned goods are subject to a 25% restocking charge, plus cost of reconditioning, if necessary, to make material saleable. Material must be returned to BEECO® freight prepaid only after written permission from BEECO® to accept the returned material. Buyer must provide copy of the original invoice on which the material was charged. The original outgoing freight cost to ship the order will be deducted from the credit. Credit allowance will be in the form of merchandise credit only-not cash credit which must be used within 12 months of the date of issue. The value of a return must total \$100 to qualify for credit allowance. Products designated non stock and / or that have been specially made (require a sign off drawing by BEECO®) are not subject to return or cancellation.

LIMITED WARRANTY: BEECO® warrants each product against defects in material and workmanship for a period of one year from the date of original shipment. In the event of such defects within the warranty period, BEECO® will, at its option, replace or recondition the product without charge. This shall constitute the exclusive remedy for breach of warranty, and BEECO® shall not be responsible for any incidental or consequential damages, including, without limitation, damages or other costs resulting from labor charges, delays, vandalism, negligence, fouling caused by foreign material, damage from adverse water conditions, chemicals, or any other circumstances over which BEECO® has no control. This warranty shall be invalidated by any abuse, misuse, misapplication or improper installation of the product. For inoperative products beyond the warranty period, we assume no liability for replacement of valves due to service conditions beyond our control. Consult local codes and specifications and have a qualified licensed professional install all BEECO® devices.

BEECO® MAKES NO OTHER WARRANTIES EXPRESSED OR IMPLIED AS PROVIDED IN THIS LIMITED WARRANTY.

ILLUSTRATIONS OR TYPICAL INSTALLATIONS: The typical installations for various products in each product section are intended to illustrate the products and their options. Under no circumstances are they to be construed as recommended installation procedures. Consult local codes and project specifications for proper installation instructions.

ALL SALES SUBJECT TO BEECO®'s TERMS AND WARRANTIES.

NOTE: Prices and terms are subject to change without notice and supersede all previous quotations. The right is reserved to change or modify product design or construction without prior notice and without incurring any obligation to make similar changes and modifications to product previously or subsequently sold. Contact BEECO® for any clarification.

CONTENTS © BEECO® INC. Copyright 2026

CALIFORNIA PROPOSITION 65 WARNING. This product contains chemicals known to the State of California to cause cancer and birth defects or other reproductive harm.

MIFAB CATALOGS



MPB-2025-04-USA
SPECIFICATION
DRAINAGE
PRODUCTS
(LIT-067)



CLPB-2025-04
LIGHT COMMERCIAL
DRAINAGE PRODUCTS
(LIT-048)



AD-2026-USA
ACCESS DOORS
CATALOG 2026
(LIT-043)



BEECO-2026
BACKFLOW PREVENTERS,
AND ACCESSORIES
(LIT-071)



NH-2026
NO HUB COUPLINGS
(LIT-044)



TDPC-2026
POLYMER CONCRETE
TRENCH DRAINS
(LIT-076)



TD-2026
GRP AND STEEL
TRENCH DRAINS
(LIT-046)



TDSD-2026
SHOWER DRAINS
(LIT-077)



TDSS-2026
STAINLESS STEEL
TRENCH DRAINS
(LIT-072)



ROOFGUARD-2020
ROOFGUARD
ROOF DRAINS
(LIT-058)



C-PORT-2026
ROOFTOP RUBBER
PIPE SUPPORTS
(LIT-047)



DB-2026
DIALYSIS BOXES
(LIT-070)



HYDROMAX-2020
SIPHONIC DRAINAGE
(LIT-082)



INT-2026
INTERCEPTORS & ACID
NEUTRALIZATION TANKS
(LIT-095)



TSP-2025
TRAP SEAL PRIMERS
(LIT-062)



CALIFORNIA PROPOSITION 65 WARNING. This product contains chemicals known to the State of California to cause cancer and birth defects or other reproductive harm.



A DIVISION OF:  **MIFAB**®



Visit www.beecobackflow.com for the most recent product information.

FLOW CONTROL SYSTEMS